

Installation Manual

Platinum
Pro/Platinum
Touch/Rotem
One/Rotem
Pro



Platinum Pro/Platinum Touch/ Rotem One/Rotem Pro Climate Controllers

Ag/MIS/ImGB-2601-06/18 Rev 2.3

P/N: 116472



Platinum Pro/Platinum Touch/ Rotem One/Rotem Pro

Installation Manual

Revision: N2.3 of 08.2024

Product Software: Version 6.26/7.26

This manual for use and maintenance is an integral part of the apparatus together with the attached technical documentation.

WARNING! *This document is destined for the user of the apparatus; it may not be reproduced in whole or in part, committed to computer memory as a file or delivered to third parties without the prior authorization of the assembler of the system.*

Munters reserves the right to effect modifications to the apparatus in accordance with technical and legal developments.

Index

<i>Chapter</i>		<i>page</i>
1	INTRODUCTION	6
1.1	Disclaimer.....	6
1.2	Introduction	6
1.3	Notes	6
2	PRECAUTIONS	7
2.1	English.....	7
2.1.1	Protection Against Corrosion	7
2.1.2	Electrical Guidelines.....	8
2.1.3	Grounding	8
2.1.4	Reducing Interference	8
2.1.5	Filtering	8
2.1.6	Checking the Battery Level	9
2.1.7	Safety Precautions - Details	9
2.1.8	Grounding the Controller	9
2.1.8.1	Ground Rods	9
2.1.8.2	Ground Wire.....	10
2.1.8.3	Ground Clamps.....	10
2.1.8.4	What Should Be Grounded?	10
2.1.8.5	Lightening Protection	10
2.1.8.6	Power Line Protection	11
2.1.8.7	Communication Line Protection	11
2.2	Française	11
2.2.1	Protection Contre la Corrosion	11
2.2.2	Directives Électriques	12
2.2.3	Raccord à la Terre (Sensores)	12
2.2.4	Réduire les Interférences	12
2.2.5	Filtrage.....	12
2.2.6	Vérification du Niveau de la Batterie	13
2.2.7	Précautions de Sécurité - Détails	13
2.2.8	Mise à la Terre Pour les Contrôleurs.....	13
2.2.8.1	Piquets de Prise de Terre	13
2.2.8.2	Fil de Garde	14
2.2.8.3	Colliers de Mise à la Terre	15
2.2.8.4	Quels Elements Doivent etre mis a la Terre?.....	15

2.2.8.5	Protection Parafoudre.....	15
2.2.8.6	Protection de Ligne Électrique	15
2.2.8.7	Protection de la Ligne de Communication	15
3	SPECIFICATIONS	16
4	BEFORE USING	18
4.1	Layout.....	18
4.1.1	Number of Relays	18
4.1.2	Platinum Pro Layout	19
4.1.3	Rotem One Layout.....	20
4.2	Typical Accessories	21
4.3	Product Symbols	23
4.4	Rotem One/Rotem Pro: Normally Open/Closed Cards.....	23
5	MOUNTING THE UNITS.....	24
5.1	Installing the Platinum Pro.....	24
5.1.1	What Comes in the Package	24
5.1.2	Mounting the Platinum Pro.....	24
5.1.3	Drilling	25
5.2	Installing the Rotem One.....	26
5.2.1	What Comes in the Package	26
5.2.2	Knockouts.....	27
5.2.3	Mounting.....	27
6	HIGH VOLTAGE WIRING.....	29
6.1	Power Supply.....	29
6.2	RPLP Wiring.....	30
6.3	Relay Wiring.....	31
6.3.1	Platinum Pro Relay Wiring	31
6.3.2	Rotem One Relay Wiring	32
6.3.3	Final Steps	32
6.4	Winch Card Relay Wiring.....	33
6.4.1	Platinum Pro Winch Card Relay Wiring.....	33
6.4.2	Rotem One Winch Card Relay Wiring.....	34
6.5	Completing the Wiring.....	35
7	LOW VOLTAGE WIRING	36
7.1	Analog Input Wiring.....	36
7.1.1	Analog Card DIP Switches	37
7.1.2	Analog Input Wiring Diagram for Temperature Sensors.....	38
7.1.3	Analog Input Wiring Diagram for CO2	39
7.1.4	Analog Input Wiring Diagram for RLS.....	40
7.1.5	Analog Input Wiring Diagram for Potentiometers.....	41
7.1.6	Analog Input Wiring Diagram for Humidity Sensors.....	42

7.1.7	Analog Input Wiring Diagram for Ammonia Sensors	43
7.2	Weather Station Wiring	44
7.3	Digital Input Wiring	48
7.4	Analog Output Wiring	49
7.5	Alarm Card Wiring	50
7.6	Communication Card Wiring	51
7.7	RS-485 Termination	52
7.7.1	Controllers and Comm-Box	52
7.7.2	Controllers and Communicator	53
7.7.3	Controller, Relay Expansion, RSU-2 and HUB	53
7.7.4	Placing the Terminator	55
8	SCALE CARD WIRING	57
8.1	Bird Scale Wiring	57
8.2	Feed Scale Wiring	58
8.3	Silo Scale Wiring	59
9	APPENDIX A: PLATINUM PRO METAL ASSEMBLY	61
9.1	Metal Assembly Precautions	61
9.2	Panels	62
9.3	Panel Dimensions	63
9.4	Mounting the Panels	67
9.5	Connecting the Metal Panels	68
9.5.1	Precautions	68
9.5.2	Panel Mount Cable Connections	69
10	APPENDIX B: ROTEM ONE WINCH CARD SET REPLACEMENT	74
10.1	General	75
10.2	In Practice	75
10.3	Relay Card Layout Considerations	76
11	APPENDIX C: APPENDIX D: ELECTROMAGNETIC NOISE SUPPRESSION CIRCUIT/CIRCUIT DE SUPPRESSION DE BRUIT ELECTROMAGNETIQUE	77
11.1	English	77
11.2	Française	78
12	WARRANTY	79

1 Introduction

- Disclaimer
- Introduction
- Notes

1.1 Disclaimer

Munters reserves the right to make alterations to specifications, quantities, dimensions etc. for production or other reasons, subsequent to publication. The information contained herein has been prepared by qualified experts within Munters. While we believe the information is accurate and complete, we make no warranty or representation for any particular purposes. The information is offered in good faith and with the understanding that any use of the units or accessories in breach of the directions and warnings in this document is at the sole discretion and risk of the user.

1.2 Introduction

Congratulations on your excellent choice of purchasing a Platinum Pro, Platinum Touch, Rotem Pro, or Rotem One!

In order to realize the full benefit from this product it is important that it is installed, commissioned and operated correctly. Before installation or using the controller, this manual should be studied carefully. It is also recommended that it is kept safely for future reference. The manual is intended as a reference for installation, commissioning and day-to-day operation of the Munters Controllers.

1.3 Notes

Date of release: May 2009

Munters cannot guarantee to inform users about the changes or to distribute new manuals to them.

All rights reserved. No part of this manual may be reproduced in any manner whatsoever without the expressed written permission of Munters. The contents of this manual are subject to change without notice.

2 Precautions

CAUTION Protection provided by the equipment can be impaired if the equipment is used in a manner not specified by the manufacturer!

CAUTION There is a risk of explosion if the lithium battery is replaced with an incorrect type. Replace the battery using the same type and manufacturer only.

- English
- Française

2.1 English

- Protection Against Corrosion
- Electrical Guidelines
- Grounding
- Reducing Interference
- Filtering
- Checking the Battery Level
- Safety Precautions - Details
- Grounding the Controller

2.1.1 PROTECTION AGAINST CORROSION

To prevent against corrosion of electrical components:

- Installation location: Install electronic controls in a separate ventilated control room that is protected from extreme temperatures and dirty environments. Place the controls so that the operators can conveniently use the control and read indicators and displays.
- Keep the controller closed at all times when a litter or passel is present in the building. In situations where maintenance or repairs are required, close the controller when you finish the work.
- After running the cables through the knockouts, seal the holes with a silicon sealant. If you use silicon sealant with acetic acid cure, keep the controller open and ventilated until cured. Otherwise, the acetic acid will attack metal components, including circuitry.
- When splicing sensors to longer wires, ensure that the splice is **waterproof**. Use adhesive lined heat shrink (marine grade) to make waterproof connections.
- Use shielded wiring for low level signals. For buried wiring (building to building runs) use high grade jell filled cables that are impervious to moisture.

2.1.2 ELECTRICAL GUIDELINES

- Munters strongly recommends that only panel mount controllers should be installed directly in an electrical closet.
- Placing this unit in proximity (2 meters/6.5 feet or less) to any electrical device that transmits 10 amps or more of current can result in severe signal interference.
- Review the guidelines given in Safety Precautions - Details, page 9 for details. These are vital to ensuring both personal safety and proper controller functioning.

2.1.3 GROUNDING

- Every low power device (digital, analog, or communication) must have a shield cable connected to the unit ground strip.

2.1.4 REDUCING INTERFERENCE

- Avoid mixing high voltage wiring with sensor and low voltage wiring. There should be at least one meter/3 feet between sensor and electrical cables.
- Keep the controller as far as possible from heavy contactor boxes and other sources of electrical interference.
- Do not connect communication wire shields, which go from one house to another at both ends. Connect them at one end only. Connection at both ends can cause ground loop currents to flow, which reduce reliability.
- The COM connection for communications is not the shield wire. The COM, RX and TX wires must connect to each other at all controllers.

2.1.5 FILTERING

If this installation includes a power inverter to drive variable speed fans, RLD, RVS-2, or any device that switches high electrical current, install an EMI filter in front of the device. Refer to the device documentation.

In particular verify:

- That the cable shielding between the device and any motor meets industry standards
- Proper grounding of the device's chassis and motor power cable
- Proper grounding of low voltage cable shield wire
- That the controller and device cables are kept in separate conduits or wire bundles

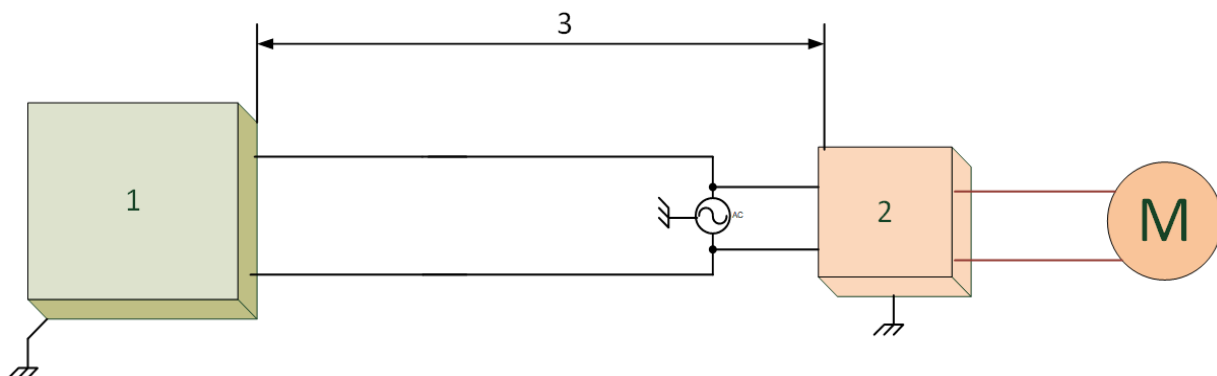

Figure 1: Inverter Placement

1. Controller
2. High electrical current device
3. Place the controller at least five meters from the device

2.1.6 CHECKING THE BATTERY LEVEL

Check the battery once a year. The output must be 2.7 volts (minimum). Authorized personnel only must replace the battery if the output is below the minimum required level or every five years. Use a RENATA-CR2450N battery only.

2.1.7 SAFETY PRECAUTIONS - DETAILS

CAUTION *These units must be installed by an authorized electrician. Disconnect the power to avoid electrical shock and damage.*

NOTE *Installation Category (Over voltage Category) II*

- The power supply to the controller should be protected by a 10 amp circuit breaker.
- All electrical connections should comply with National Electrical code (NEC).

2.1.8 GROUNDING THE CONTROLLER

- Ground Rods
- Ground Wire
- Ground Clamps
- What Should Be Grounded?
- Lightning Protection
- Power Line Protection
- Communication Line Protection

2.1.8.1 Ground Rods

Ground rods are used to efficiently connect the system to earth where current may be dissipated in the soil.

1. Material: Ground rods should be copper clad or galvanized steel.
2. Diameter: Minimum 5/8", preferably 3/4". Generally the larger the rod diameter, the lower it's resistance to current flow.
3. Length: Minimum 2.5 meters (8 feet), preferably 3-meter (10-foot). A longer ground rod will reach a soil with higher moisture content. Moist soil carries current much better than drier soil.
4. Single grounding: It is important that there is only one grounding location where a rod or series of rods are connected to each other using a ground wire.
5. Independent ground rods will increase the risk of current, from a lightning strike for example, being dissipated through one rod and reentering the system through an adjacent rod.
6. Location: Close to the main circuit breaker panel and in moist soil. For example in an area that is usually wet from a drip or a low spot where water drains. Make sure the area is well protected from damage by lawnmowers, tractors, etc.'

7. Rod installation: Drive the rod into the earth until about 10 cm (4 inches) is left above grade. If it is impossible to drive the rod to the proper depth, it is acceptable to lay the rod horizontally, 80 cm (2.5 feet) below grade.

8. In case the rod is exposed to damage, for example by lawnmowers or tractors it can be installed in a hole, about 20 cm (8 inches) deep so that the rod is about 10 cm under grade and 10 cm above hole level.

NOTE The National Electric Code (NEC) mandates two ground rods unless you can show less than 10 ohms resistance with one rod.

2.1.8.2 Ground Wire

The ground wire is a large copper wire that connects the main circuit breaker panel to the ground rod.

1. Material: Ground rods should be copper clad or galvanized steel.
2. Diameter: Typically, 16 mm (6-gauge) copper wire is sufficient. If the wire run is greater than 20 feet, 20 mm (4-gauge) wire should be used.
3. Length: Minimum 2.5 meters (8 feet), preferably 3-meter (10-foot). A longer ground rod will reach a soil with higher moisture content. Moist soil carries current much better than drier soil.
4. The ground wire should be protected from damage by lawnmowers, tractors, etc. It should be buried minimum 15 cm (6 inches) under grade for protection and enter the house as soon as possible. It is important that the wire not be cut; it should remain continuous.

2.1.8.3 Ground Clamps

Ground wires should not be merely wrapped around a ground rod. Ground clamps are used to attach a ground wire to a ground rod. The most common clamp is known as an acorn clamp. Make sure the ground clamps you select are rated for outdoor use. Do not use pipe clamps rated for inside water lines or hose clamps to attach the ground wire.

2.1.8.4 What Should Be Grounded?

Any equipment that is or could become energized, even accidentally, should be grounded. Current from lightning, strikes objects in a random fashion. Accounts of lightning strikes reveal scenarios most of us could not predict.

Electric circuits should be wired with a 3-wire conductor consisting of hot, neutral, and grounding wires. The grounding wire should be attached cleanly and securely to devices or systems to be grounded. The other end of the grounding wire should be attached to the ground bus on the main panel.

2.1.8.5 Lightning Protection

Because of the potential for lightning damage to electronic devices, Munters recommends supplying lightning protection on both the power supply and the communication terminals (if used).

2.1.8.6 Power Line Protection

The RPLP-1 provides lightning protection to the controllers. Refer to the RPLP-1 documentation for detailed wiring instructions. While no lightning protection is perfect, the RPLP-1 significantly enhances the reliability of built-in lightning protection. In addition, Munters recommends using an isolation transformer in front of the RPLP-1 to help block lightning and other transients.

NOTE Common surge protectors provide little additional protection and may trip unnecessarily.

An isolation transformer preceding the RPLP-1 provides significant additional protection against lightning.

2.1.8.7 Communication Line Protection

The RCLP-1 provides communication protection for the controller. Refer to the RCLP-1 documentation for detailed wiring instructions. Since outdoor communication lines can receive and conduct powerful electromagnetic pulses into the controllers and cause significant damage, Munters advises using a RCLP-1 prevent damage to the units.

NOTE Common surge protectors provide little additional protection and may trip unnecessarily.

2.2 Française

- Protection Contre la Corrosion
- Directives Électriques
- Raccord à la Terre (Sensores)
- Réduire les Interférences
- FiltrageVérification du Niveau de la Batterie
- Précautions de Sécurité - Détails
- Mise à la Terre Pour les Contrôleurs

2.2.1 PROTECTION CONTRE LA CORROSION

Pour éviter la corrosion des composants électriques:

- Installez les commandes électroniques dans une salle de commande ventilée séparée, à l'abri des températures extrêmes et des environnements sales. Placer les commandes de façon à ce que les opérateurs puissent facilement les utiliser et lire les indicateurs et les affichages.
- Gardez le contrôleur fermé à tout moment lorsqu'il y a de la poubelle ou un passage dans le bâtiment. Dans les situations nécessitant une maintenance ou des réparations, fermez le contrôleur lorsque vous avez terminé le travail.
- Après avoir acheminé les câbles à travers les ouvertures, scellez les trous avec un produit d'étanchéité au silicone. Si vous utilisez un mastic de silicone avec durcissement à l'acide acétique, maintenez le contrôleur ouvert et ventilé jusqu'à ce qu'il durcisse. Sinon, l'acide acétique attaquera les composants métalliques, y compris les circuits.

- Lors du raccordement de capteurs à des câbles plus longs, assurez-vous que le raccordement est étanche. Utilisez une gaine thermorétractable adhésive (qualité marine) pour réaliser des connexions étanches.
- Utilisez un câblage blindé pour les signaux de faible niveau. Pour les câbles enterrés (d'un bâtiment à l'autre), utilisez des câbles remplis de gel de haute qualité, imperméables à l'humidité.

2.2.2 DIRECTIVES ÉLECTRIQUES

- Munters recommande vivement que seuls les contrôleurs montés sur panneau soient installés directement dans une armoire électrique.
- Si cette unité est installée dans une armoire électrique, assurez-vous qu'il n'y a pas de contacteurs dans cette armoire. L'installation de cette unité à proximité de contacteurs (2 mètres/6,5 pieds maximum) entraîne de graves interférences de signal.
- Consulter les consignes données dans Safety Precautions - Details, page XX pour plus de détails. Elles sont essentielles pour garantir à la fois la sécurité personnelle et le bon fonctionnement du contrôleur.

2.2.3 RACCORD À LA TERRE (SENSORES)

- Chaque appareil à faible puissance (numérique, analogique ou de communication) doit être équipé d'un câble blindé raccordé à la barrette de mise à la terre de l'unité.

2.2.4 RÉDUIRE LES INTERFÉRENCES

- Maintenez les câbles basse tension séparés des câbles haute tension. Il doit y avoir au moins un mètre entre le capteur et les câbles électriques.
- Maintenez le contrôleur aussi loin que possible du boîtier lourd de contacteur et des autres sources d'interférences électriques.
- Ne connectez les protections des fils de communication, allant d'une maison à une autre aux deux extrémités. Connectez-les à une seule extrémité uniquement. La connexion aux deux extrémités peut entraîner la circulation de courants dans la boucle de terre, et risquer ainsi de réduire la fiabilité.
- La connexion COM pour les communications n'est pas le fil blindé. Les fils COM, RX et TX doivent être connectés les uns aux autres au niveau de tous les contrôleurs.

2.2.5 FILTRAGE

Si cette installation comprend un onduleur pour entraîner des ventilateurs à vitesse variable, RLD, RVS-2 ou tout autre dispositif qui commute un courant électrique élevé, installez un filtre EMI devant l'appareil. Reportez-vous à la documentation de l'appareil.

- Que le blindage du câble entre l'appareil et tout moteur est conforme aux normes industrielles
- Mise à la terre correcte du châssis de l'appareil et du câble d'alimentation du moteur
- Mise à la terre correcte du fil blindé du câble basse tension

- Que les câbles du contrôleur et de l'appareil sont conservés dans des conduits ou faisceaux de câbles séparés

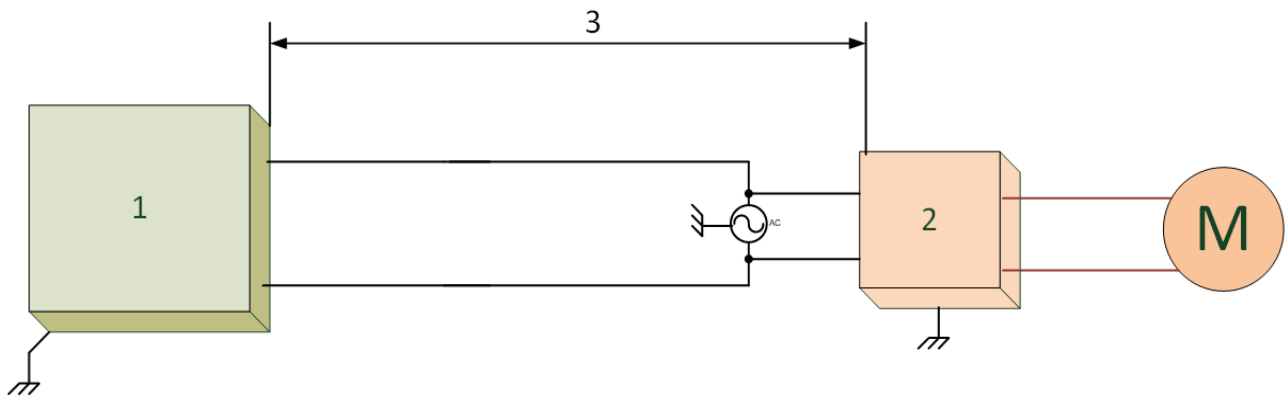

Illustration 2: Emplacement de l'onduleur

1. Contrôleur
2. Dispositif de courant électrique élevé
3. Placez le contrôleur à au moins cinq mètres de l'appareil

2.2.6 VÉRIFICATION DU NIVEAU DE LA BATTERIE

Vérifiez la batterie une fois par an. La sortie doit être 2.7 volts (minimum). Seul le personnel autorisé est en droit de remplacer la batterie si la sortie est inférieure au niveau minimum ou tous les cinq ans. Utilisez uniquement une batterie RENATA-CR2450N.

2.2.7 PRÉCAUTIONS DE SÉCURITÉ - DÉTAILS

NOTE Catégorie d'installation (catégorie de surtension) II

- L'alimentation électrique du contrôleur doit être protégée par un disjoncteur de 10 A.
- Tous les raccordements électriques doivent être conformes au National Electrical Code (NEC)

2.2.8 MISE À LA TERRE POUR LES CONTRÔLEURS

- Piquets de Prise de Terre/Fil de Garde
- Colliers de Mise à la Terre
- Quels Elements Doivent etre mis a la Terre?
- Protection Parafoudre
- Protection de Ligne Électrique
- Protection de la Ligne de Communication

2.2.8.1 Piquets de Prise de Terre

Les piquets de prise de terre sont utilisés pour connecter efficacement le système à la terre, lorsque le courant peut être dissipé dans le sol.

1. Matériel: Les piquets de prise de terre doivent être plaqués cuivre ou en acier galvanisé.
2. Diamètre: Minimum 12,5/20,3 cm, de préférence 7,6/10,16 cm. Généralement, plus le diamètre du piquet est gros, moindre sera sa résistance à la circulation du courant.
3. Longueur: Au minimum 2,5 mètres, de préférence 3 mètres. Un piquet de prise de terre plus long atteindra un sol avec une humidité plus élevée. Des sols humides portent beaucoup mieux le courant que des sols plus secs.
4. Mise à la terre unique: Il est essentiel qu'il n'y ait qu'un seul emplacement de mise à la terre auquel un piquet ou une série de piquets sont connectés les uns aux autres à l'aide d'un fil de garde.
5. Des piquets de prise de terre indépendants augmenteraient le risque de courant, provenant par exemple d'un éclair, dissipé par un piquet et réintégrant le système par un piquet adjacent.
6. Emplacement: Prêt du panneau de disjoncteur principal et dans un sol humide. Par exemple, dans une zone qui est habituellement humide provenant de précipitation, ou un point bas où l'eau est drainée. Assurez-vous que la zone est bien protégée des dommages pouvant être causés par des tondeuses à gazon, des tracteurs, etc.
7. Installation du piquet: Enfoncez le piquet dans le sol jusqu'à ce qu'il reste 10 cm au dessus du niveau du sol. S'il est impossible d'enfoncer le piquet à une profondeur correcte, vous pouvez poser le piquet horizontalement, 80 cm en dessous du niveau du sol.
8. Dans le cas où le piquet risque d'être endommagé, par exemple, par des tondeuses à gazon ou des tracteurs, il peut être installé dans un trou, à une profondeur d'environ 20 cm pour que le piquet soit environ 10 cm en dessous du niveau du sol et 10 cm au dessus du niveau du trou.

NOTE Le National Electric Code (NEC) a comme impératif l'utilisation de deux piquets de prise de terre, à moins que vous puissiez montrer que la résistance est inférieure à 10 ohms avec un piquet.

2.2.8.2 Fil de Garde

Le fil de garde est un fil cuivré long et épais qui connecte le panneau du disjoncteur principal au piquet de prise de terre.

1. Matériel: Les piquets de prise de terre doivent être plaqués cuivre ou en acier galvanisé.
2. Diamètre: Généralement un fil cuivré de 16 mm (de calibre no. 6) suffit. Si le fil doit parcourir plus de 7m, un fil de 20 mm (de calibre no.4) devrait être utilisé.
3. Longueur: Au minimum 2,5 mètre, de préférence 3 mètres. Un piquet de prise de terre plus long atteindra un sol avec une humidité plus élevée. Des sols humides portent beaucoup mieux le courant que des sols plus secs.
4. Le fil de garde devrait être protégé des dommages pouvant être provoqués par des tondeuses à gazon, des tracteurs, etc. Il devrait être enterré au moins à 15 cm sous le sol pour protection, et être inséré dans la maison aussi vite que possible. Il est important que le fil ne soit pas coupé, il devrait rester entier.

2.2.8.3 Colliers de Mise à la Terre

Des fils de gardes ne devraient pas simplement revêtir un piquet de prise de terre. Des colliers de mise à terre sont utilisés pour attacher un fil de garde au piquet de prise de terre. Le collier le plus ordinaire est un collier ocre. Assurez-vous que les colliers de mise à terre que vous sélectionnez sont adaptés à une utilisation à l'extérieur. N'utilisez pas de collier de serrage adapté pour des conduites d'eau intérieures ou colliers de serrage pour tuyaux flexibles pour rattacher le fil de garde.

2.2.8.4 Quels Elements Doivent etre mis a la Terre?

Tout équipement qui est ou pourrait être sous tension, même accidentellement, devrait être mis à la terre. Les objets qui pourraient être aléatoirement porteurs de la foudre y sont inclus. Des récits de foudre ont montré des cas imprévisibles.

Les circuits électriques devraient être câblés avec un conducteur à 3 fils, constitué d'un fil de garde, d'un fil conducteur neutre et d'un fil chaud. Le fil de garde devrait être rattaché nettement et sûrement aux dispositifs ou aux systèmes à mettre à la terre. L'autre extrémité du fil de garde devrait être rattachée au collecteur de terre sur le panneau principal.

2.2.8.5 Protection Parafoudre

En raison du risque de dommages causés par la foudre sur les appareils électroniques, Munters recommande d'installer une protection contre la foudre sur l'alimentation électrique et les bornes de communication (le cas échéant).

2.2.8.6 Protection de Ligne Électrique

Le RPLP-1 fournit une protection contre la foudre aux contrôleurs. Reportez-vous à la documentation RPLP-1 pour des instructions de câblage détaillées. Bien qu'aucune protection contre la foudre ne soit parfaite, le RPLP-1 améliore considérablement la fiabilité de la protection contre la foudre intégrée. De plus, Munters recommande d'utiliser un transformateur d'isolement devant le RPLP-1 pour aider à bloquer la foudre et d'autres transitoires.

Les parasurtenseurs communs offrent peu de protection supplémentaire et peuvent se déclencher inutilement.





Un transformateur d'isolement précédant le RPLP-1 offre une protection supplémentaire importante contre la foudre.

2.2.8.7 Protection de la Ligne de Communication

Le RCLP-1 assure la protection de la communication pour le contrôleur. Reportez-vous à la documentation du RCLP-1 pour des instructions de câblage détaillées. Étant donné que les lignes de communication extérieures peuvent recevoir et conduire des impulsions électromagnétiques puissantes dans les contrôleurs et causer des dommages importants, Munters recommande d'utiliser un RCLP-1 pour éviter d'endommager les unités.

Les parasurtenseurs communs offrent peu de protection supplémentaire et peuvent se déclencher inutilement.

3 Specifications

Description	Specification
Input Power Voltage	<ul style="list-style-type: none"> • 100 – 240 VAC • Platinum Touch: 1A, 50/60 Hz • Platinum Pro: 0.6A, 50/60 Hz • Rotem One: 1.2A, 50/60 Hz • Rotem Pro: 0.8A, 50/60 Hz
Normally Open Relays	<ul style="list-style-type: none"> • Non Fused • 70% of relays can operate simultaneously (maximum) • 200 – 240 VAC max load: 2HP (7A during continual operation, up to 30A at startup) • 100 – 130 VAC max load: 1HP (7A during continual operation, up to 30A at startup)
Normally Close Relays	<ul style="list-style-type: none"> • Non Fused • 70% of relays can operate simultaneously (maximum) • 200 – 240 VAC max load: 1HP (4A during continual operation, up to 20 Amp at startup) • 100 – 130 VAC max load: 0.5HP (4A during continual operation, up to 20A at startup)
<p>CAUTION Switching loads over 10A reduces a relay's life span (from 100,000 operations to ~10,000 operations).</p>	
Analog Inputs	0 - 5 Volts, 5VDC maximum
Analog Output	0 - 10 Volts; maximum load: 20 mA
Digital Inputs	5 Volts, 1.5 mA, dry contact
Operating Temperature Range	0° to +50° C (32° to 125° F)
Dimensions (HxWxD)	<ul style="list-style-type: none"> • Platinum Touch/Platinum Pro: 504 x 423 x 200 mm (19.8 x 16.6 x 7.9 in) • Rotem One/Rotem Pro: 665 x 484 x 247 mm (26 x 19 x 9.7 in)
Enclosure	<ul style="list-style-type: none"> • IP: 52 • PD: 2 • Indoor use only
Fuses	Fuse F1 on PS card: 5A, 250V
Certification	   

- **Disconnection device/overcurrent protection:** In the building installation, use a certified 2-pole circuit breaker rated 10A, certified in accordance with the IEC standard 60947-2 (in the US and Canada uses a Listed Branch Circuit protective circuit breaker). This step is required to provide overcurrent protection and mains disconnection. The circuit breaker must be easily accessible and marked as the controller disconnect device.
- **Main Supply Voltage:** Permanently connect the controller to the mains in accordance with the relevant national code. Relays must be suitably protected against overcurrent, using a circuit breaker rated at 10A.
- **Keep the controller closed and locked. Only authorized personnel should open and close the unit.**

4 Before Using

*NOTE Platinum Pro refers to the Platinum Pro and Platinum Touch units unless specified.
Rotem One refers to the Rotem One and Rotem Pro units unless specified.*

- Layout
- Typical Accessories
- Product Symbols
- Rotem One/Rotem Pro: Normally Open/Closed Cards

4.1 Layout

- Number of Relays
- Platinum Pro Layout
- Rotem One Layout

4.1.1 NUMBER OF RELAYS

- Platinum Pro/Platinum Touch supports up to 30 relays
- Rotem Pro/Rotem One supports up to 50 relays
- Panel Mounts support up to 30 or 50 relays (depending on the model)

4.1.2 PLATINUM PRO LAYOUT

This illustration displays the main elements found in the Platinum Pro and Platinum Touch.

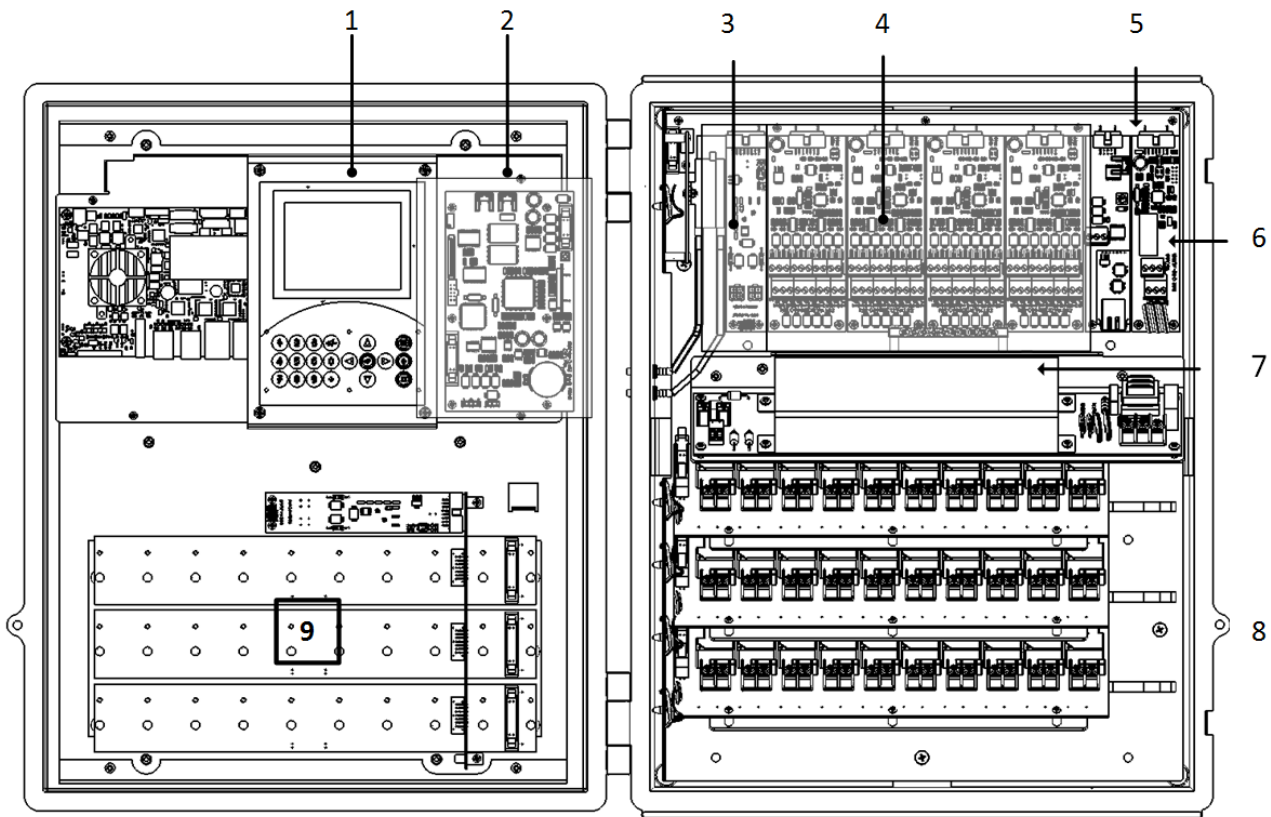

Figure 3: Platinum Pro /Platinum Touch Layout

Figure 3 key			
1	Backup screen and keyboard (Touch only)	6	Communication card
2	Main CPU card	7	Power supply
3	Communication card to Expansion unit/RLED 2.0	8	Normally Open, Normally Closed, Winch, Current Sense cards
4	Analog Input/Output and Digital Input cards	9	Switch cards
5	Alarm card		

4.1.3 ROTEM ONE LAYOUT

The following illustration displays the main elements in Rotem One units.

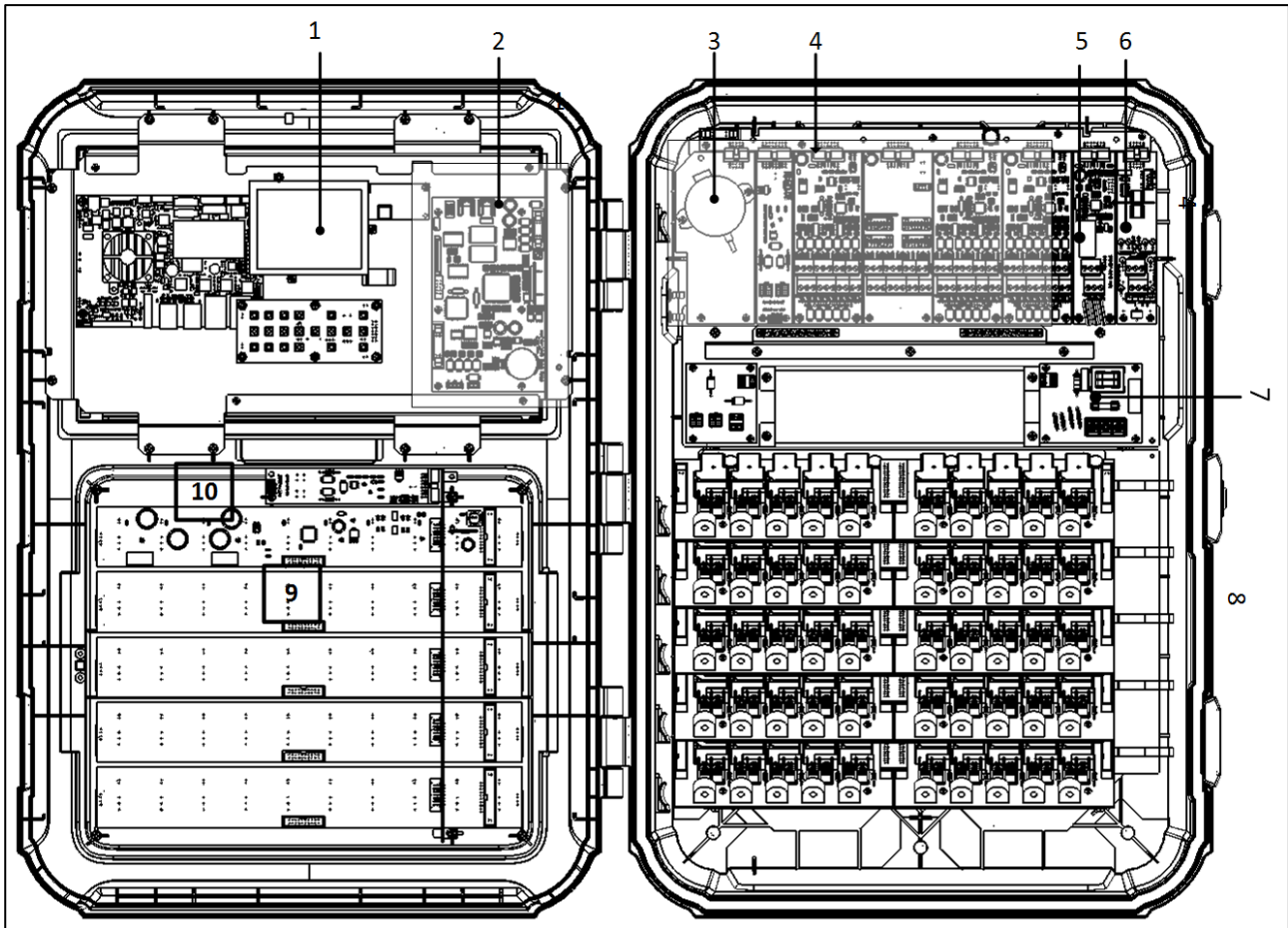

Figure 4: Rotem Pro /Rotem One Layout

Figure 4 key			
1	Backup screen and keyboard (Touch only)	6	Communication card
2	Main CPU card	7	Power supply, high voltage
3	Pressure sensor	8	Normally Open, Normally Closed, Winch, Current Sense cards
4	Analog Input/Output and Digital Input cards	9	Switch cards
5	Alarm card	10	Internal communication card

NOTE Figure 3 and Figure 4 are example layouts. Each installation can differ.

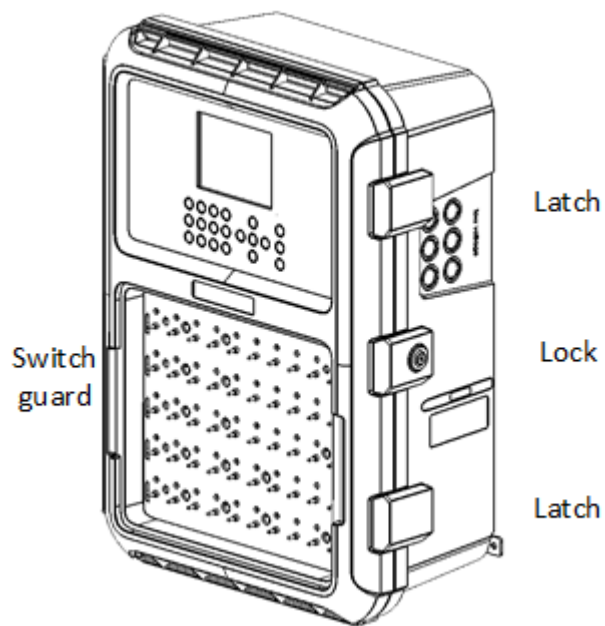

Figure 5: Rotem One External Parts

4.2 Typical Accessories

Platinum Pro and Rotem One support:

- Analog input, digital input, analog output cards
- 1 x Rotem One Expansion unit
- 5 x [RLED 2.0](#)
- 1 X [RDT-5](#) (Software version X.20 supports two RDT-5 units)
- 2 x [RSU-2](#) (Software version X.18 supports five RSU-2 units)
- 1 x [HUB-4](#)

NOTE This manual provides wiring instructions for the cards. Refer to the products' respective manuals for installation instructions.



Figure 6: Expansion units



Figure 7: RLED 2.0



Figure 8: RDT-5



Figure 9: RSU-2



Figure 10: HUB



Figure 11: Accessories

4.3 Product Symbols

The following labels appear on your controller:



: Caution! Hazardous voltage



: Caution: Refer to the manual



: Main Protective Earthing

Terminal

CAUTION IF THE UNIT IS USED IN A MANNER NOT SPECIFIED BY THE MANUFACTURER, THE PROTECTION PROVIDED BY THE EQUIPMENT MAY BE IMPAIRED.

4.4 Rotem One/Rotem Pro: Normally Open/Closed Cards

- Normally Open (only) sets include ten relays: Two (2) 5 x Normally Open relay cards along with a 10 relay switch card.
- Normally Closed relays come included in sets made up of:
 - One 5 x Normally Closed relay card. This card must be installed on the left side of the unit. See Figure 4.
 - One 5 x Normally Open relay card.
 - A switch card having five Normally Open relays and five Normally Closed relays.

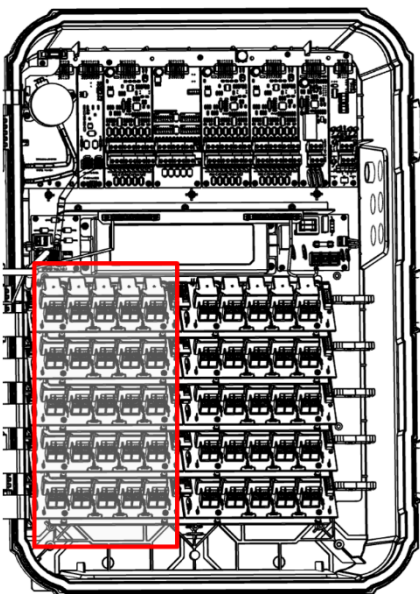

Figure 12: Normally Closed Card Installation

To order replacements:

- Rotem One / Rotem Pro - Combined Normally Close/Open Switch Card (P/N: P4-NC&NO-SC): 900-99-00336
- Rotem One / Rotem Pro - Combined Normally Close/Open Set 30A (P/N: P4-NC&NO-S-30A): 900-99-00337 (sets include relay cards and a switch)

5 Mounting the Units

The following sections detail the initial steps required when installing the controllers. Users installing the Panel Mounts, refer to Appendix A: Platinum Pro Metal Assembly.

- Installing the Platinum Pro
- Installing the Rotem One

5.1 Installing the Platinum Pro

- What Comes in the Package
- Mounting the Platinum Pro
- Drilling

5.1.1 WHAT COMES IN THE PACKAGE

- One Platinum Pro One unit
- Four hanging hooks
- Four long screws
- One packet of labels
- 2 copies of keys
- RTS-2 sensors (option)

5.1.2 MOUNTING THE PLATINUM PRO

1. Remove the mounting plates (x4) and screws (x8) from the plastic bag.



2. Fasten the mounting plates to the corners of the controller using four screws.

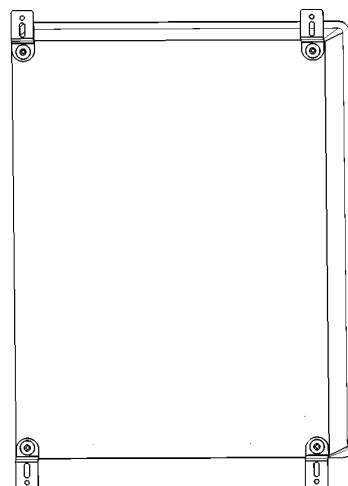

3. Place the controller box on the wall and make sure it is leveled (use a spirit level).
4. Using the remaining screws, secure the controller to the wall.

5.1.3 DRILLING

Drill holes on the side and bottom of controller box according to the steps defined below. Use these holes to route the low and high voltage cables.

CAUTION *Make sure not to damage cards when drilling holes. Locate holes properly before drilling!*

1. Drill a hole on the right side of the controller box. Verify that the low voltage cables being used go through the hole properly.

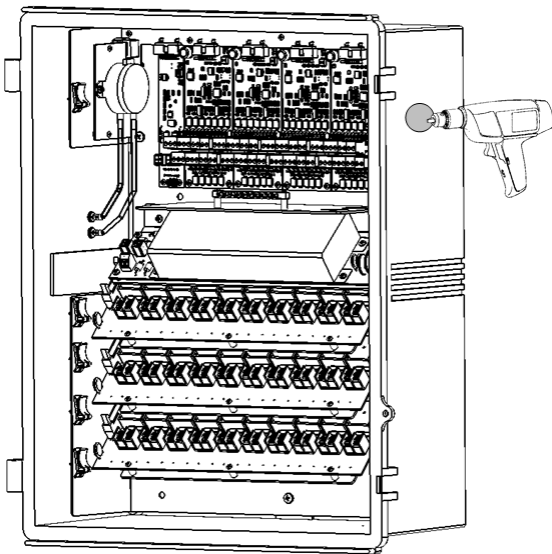

Figure 13: Drilling on the Side

2. Drill a hole on the bottom side of the controller box. Verify that the high voltage cables being used fit through the hole properly.

NOTE *Munters recommends drilling at least two (2) holes, placed as close to the front edge as possible (to avoid crowding the wiring).*

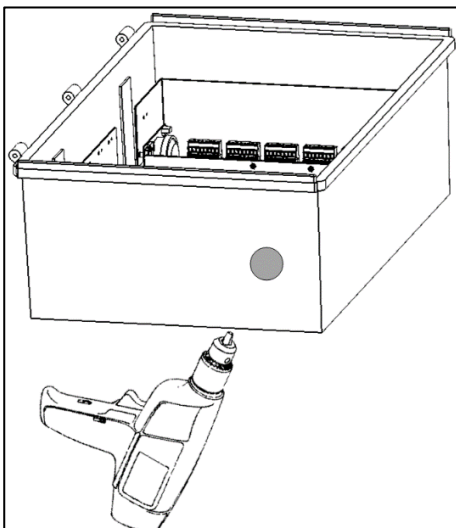

Figure 14: Drilling on the Bottom

3. Clean the holes from plastic shards. Verify that rims of holes are smooth.

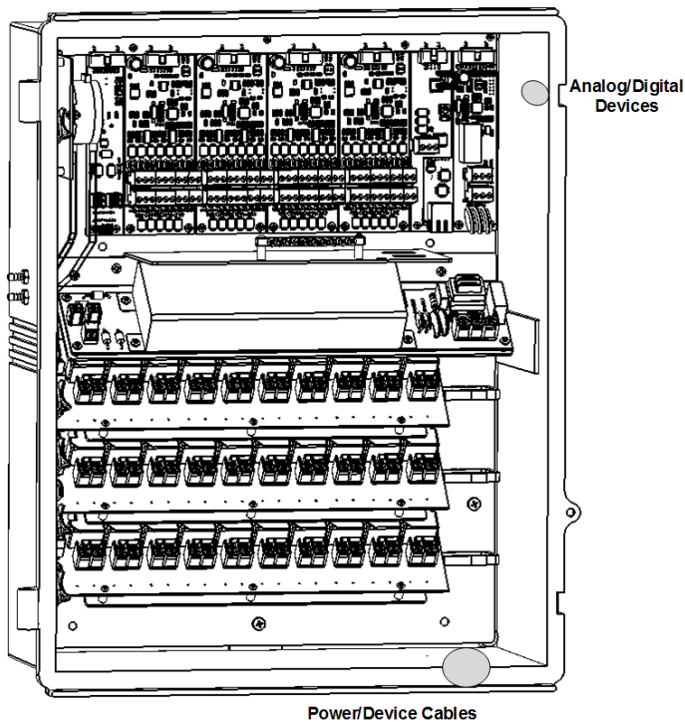

Figure 15: Hole locations

5.2 Installing the Rotem One

- What Comes in the Package
- Knockouts
- Mounting

5.2.1 WHAT COMES IN THE PACKAGE

- One Rotem One unit
- Two hanging brackets
- Six long screws
- Six short screws
- One packet of labels
- 2 copies of keys
- 4 RTS-2 sensors
- Air pressure hoses (option)

5.2.2 KNOCKOUTS

On the bottom and side of the Rotem One are knockouts used to route the low and high voltage cables.

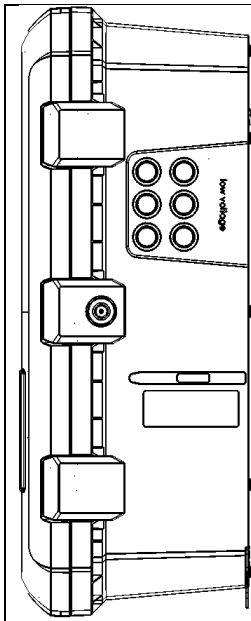

Figure 16: Low Voltage Knockouts

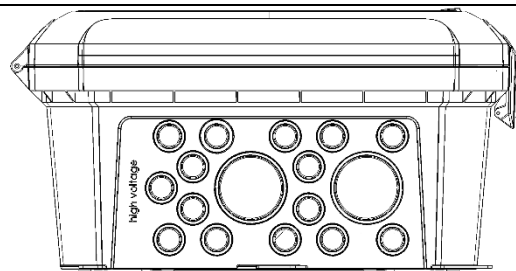

Figure 17: High Voltage Knockouts

- Using a screwdriver and a hammer, gently apply pressure to the knockouts.
- Only open the holes that you require.
- Munters recommends removing the knockouts before mounting the unit.

5.2.3 MOUNTING

Rotem One comes with two hanging brackets.

➡ Hang the Rotem One on a wall capable of supporting the unit's weight!

1. Use the supplied screws to attach the bracket to the wall.

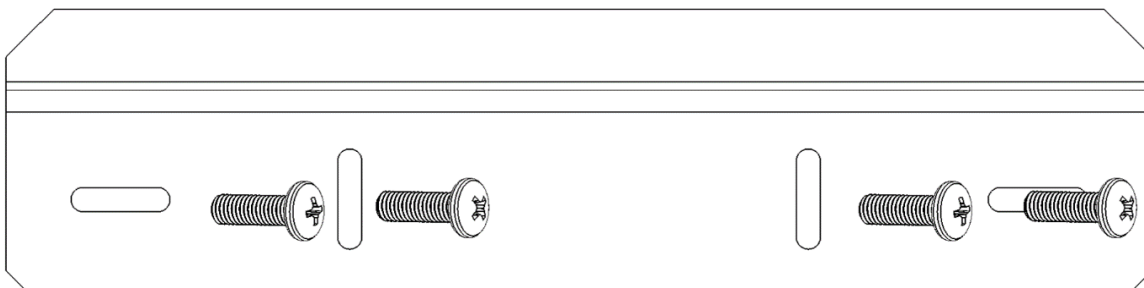

Figure 18: Wall bracket

2. Attach to the Rotem One:
 - the second hanging bracket
 - the securing brackets

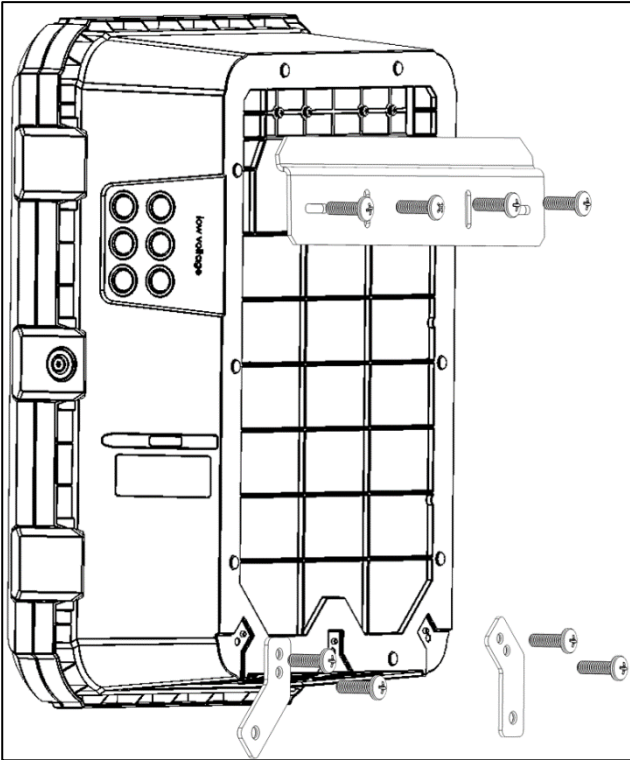

Figure 19: Unit brackets

3. Hang the Rotem One on the wall bracket and screw the securing brackets to the wall.

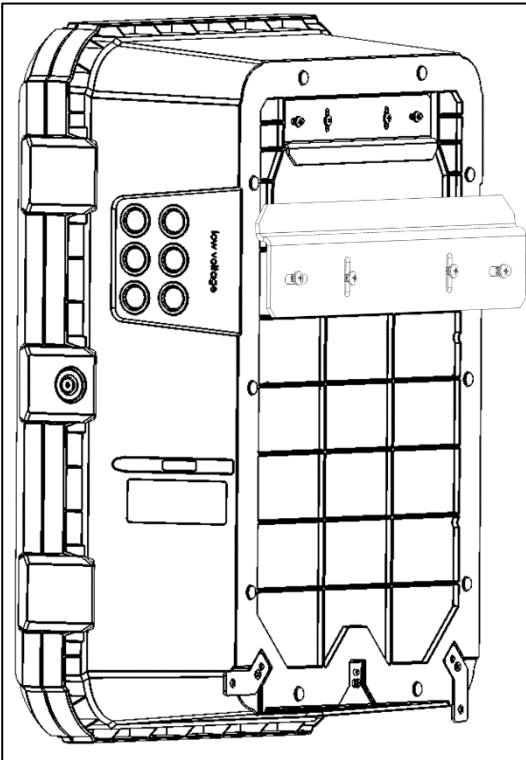

Figure 20: Mounting Completed

6 High Voltage Wiring

This section details how to wire the controller's high voltage wiring:

WARNING! Before beginning, disconnect the power supply!

CAUTION Only a qualified electrician may perform the electrical installation!

- Power Supply, page 29
- RPLP Wiring, page 31
- Relay Wiring, page 31
- Winch Card Relay Wiring, page 33
- Completing the Wiring, page 35

CAUTION Avoid mixing high voltage wiring with sensor and low voltage wiring. Keep the controller as far as possible from heavy contactor boxes and other sources of electrical interference.

6.1 Power Supply

- Main grounding wire **should come** connected to the ground terminal (1).
 - Connect electricity to the controller power supply (2).
 - Connect the grounding strip to the grounding rod (3).
- 100 - 240 VAC, 50/60 Hz; USA: L1, L2; ROW line, neutral (4)

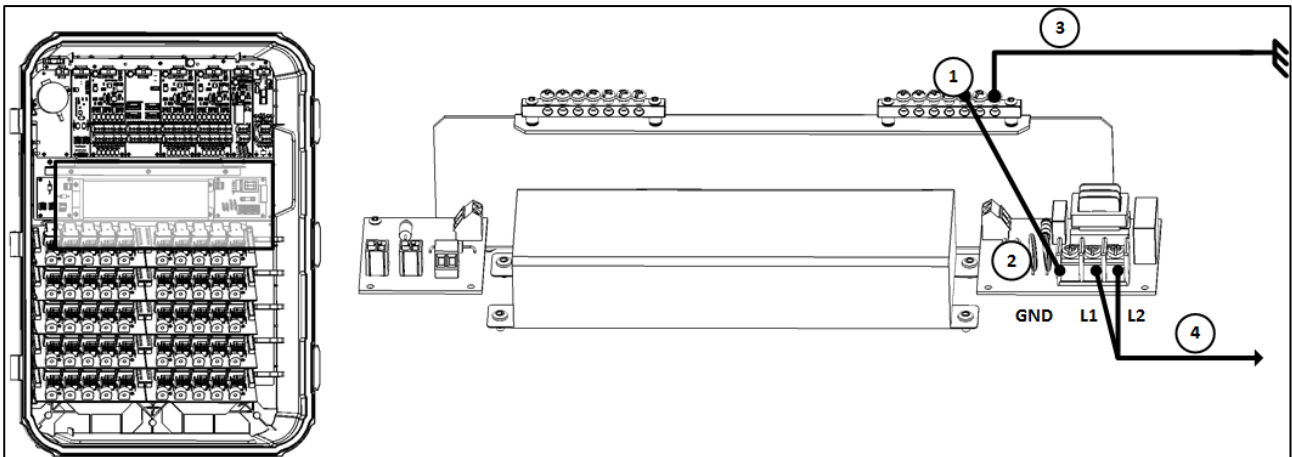

Figure 21: Power Supply Wiring Diagram

6.2 RPLP Wiring

The following section details how to wire an RPLP Lighting Protector unit to the power supply.

CAUTION Install the RPLP, 230 V only (part number P-RPLP-1-V2)!

On the RPLP's protected side:

1. Connect the RPLP grounding wire to the Rotem One grounding terminal.
2. Connect the RPLP Neutral terminal to the Rotem One L1 terminal.
3. Connect the RPLP Line terminal to the Rotem One L2 terminal (4).
 - 100 – 240 VAC, 50/60 Hz
 - USA: ground, L1, L2
 - ROW Ground, line, neutral

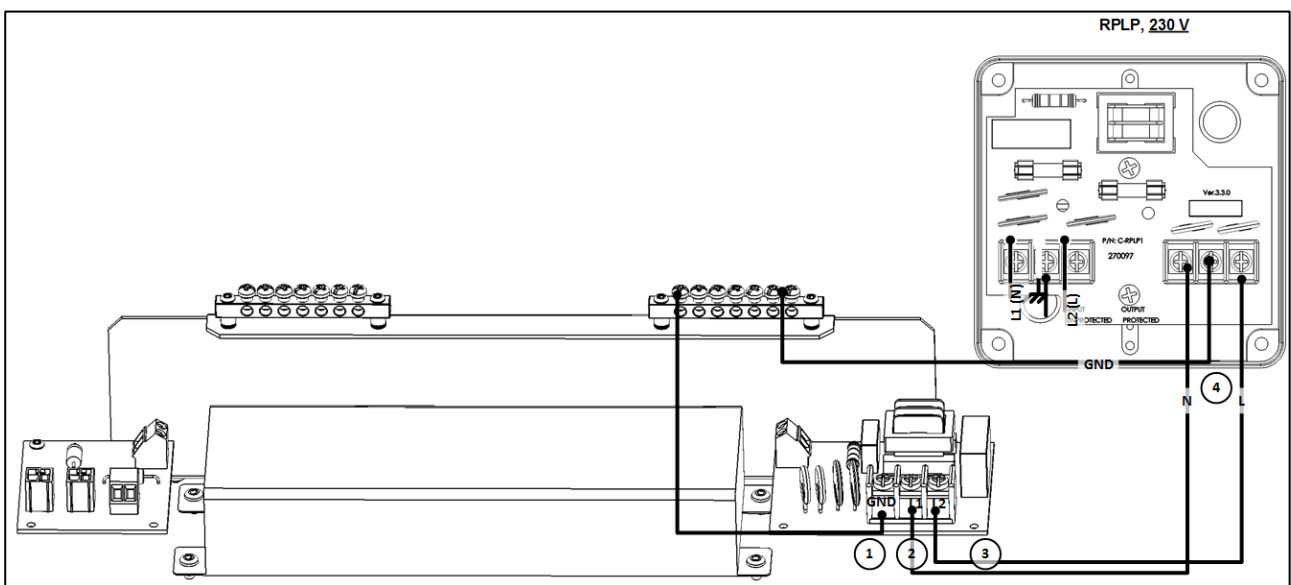

Figure 22: Wiring the RPLP

6.3 Relay Wiring

- Platinum Pro Relay Wiring
- Rotem One Relay Wiring
- Final Steps

6.3.1 PLATINUM PRO RELAY WIRING

This procedure details how to connect output relays to poultry house devices.

1. Connect the control phase commons to the relays' contacts (the common wire to all relays with the same function).

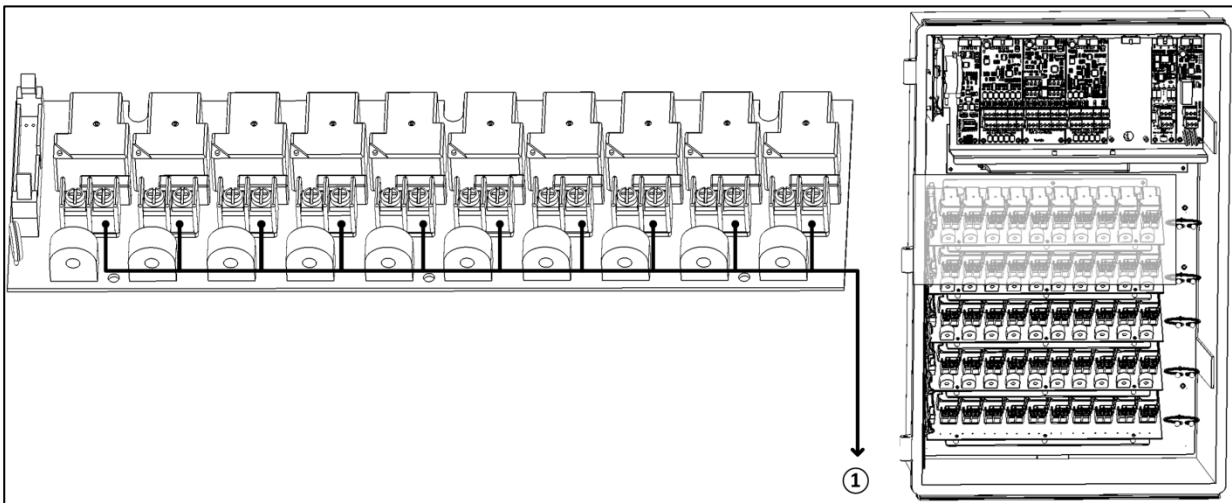

Figure 23: Control Phase Commons

Figure 23 key

1	Phase common
---	--------------

2. Connect the relay cables to each inlet/curtain/device.

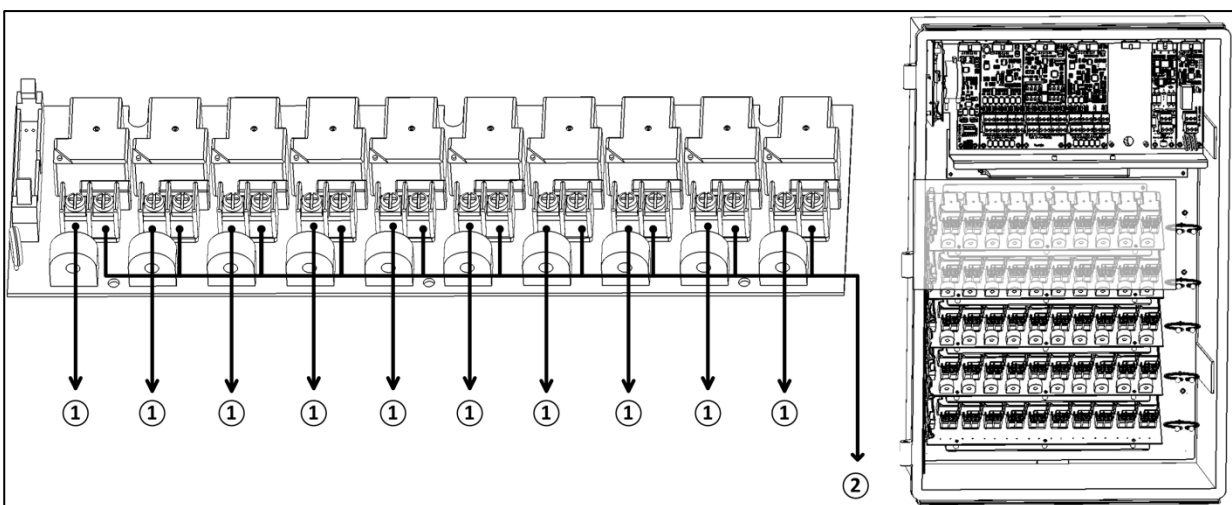

Figure 24: Relay Cable Connections

Figure 24 key

1	Cable to device
---	-----------------

2	Phase commons
---	---------------

6.3.2 ROTEM ONE RELAY WIRING

This procedure details how to connect output relays to poultry house devices.

1. Connect the control phase commons to the relays' contacts (the common wire to all relays with the same function).

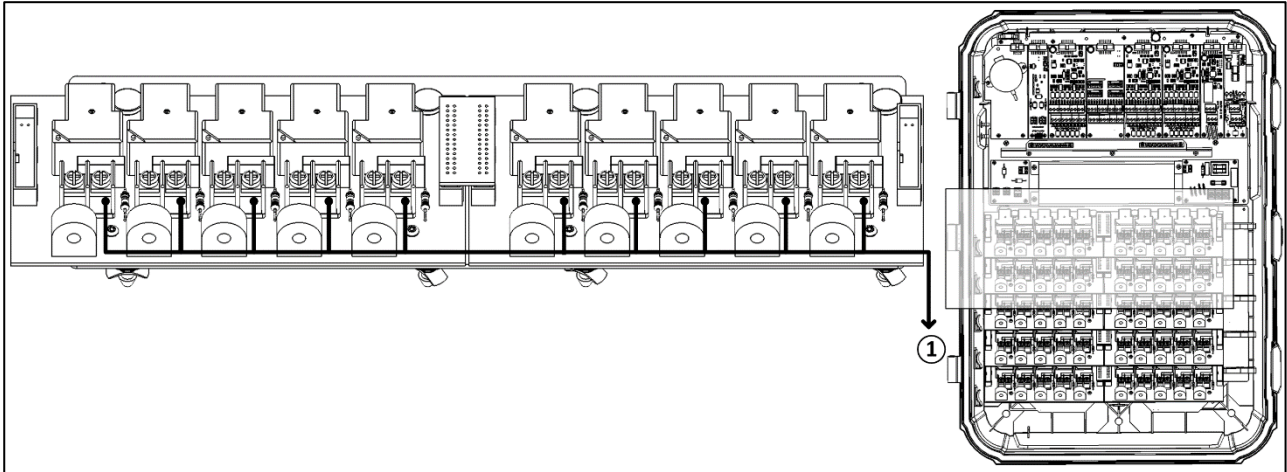

Figure 25: Control Phase Commons

Figure 25 key	
1	Phase common

2. Connect the relay cables to each inlet/curtain/device.

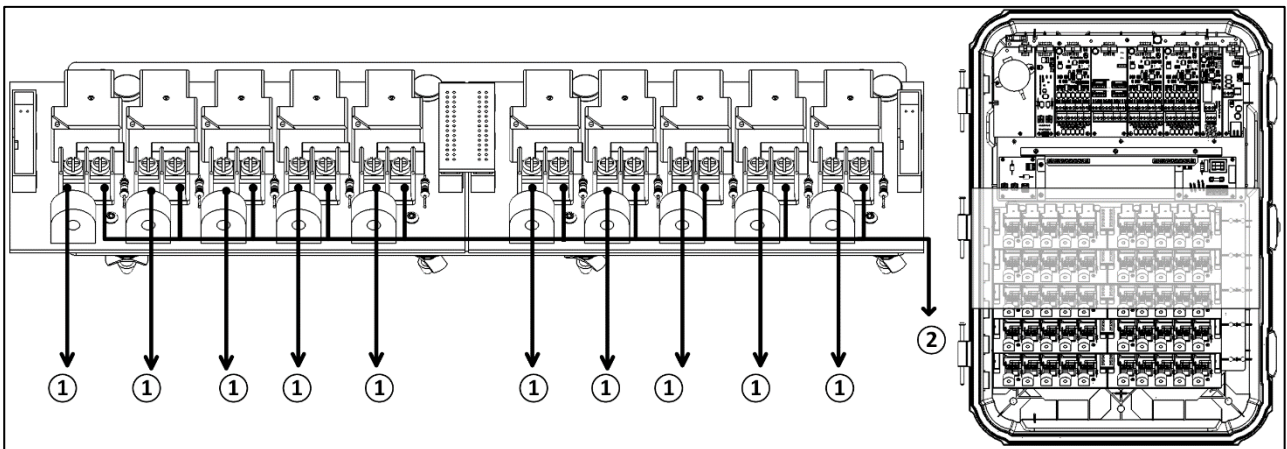

Figure 26: Relay Cable Connections

Figure 26 key			
1	Cable to device	2	Phase commons

6.3.3 FINAL STEPS

1. Locate the bag of stickers placed on the inside of the controller door.
2. On the sticker below each relay, write the name of the device connected to the relay.

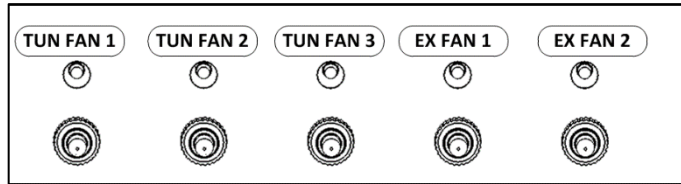

Figure 27: Controller labels

3. On the front of the controller, place the appropriate label above the switch that corresponds with the electrical setup.

6.4 Winch Card Relay Wiring

This procedure details how to connect Winch Cards to the inlets. Winch cards simplify backup (opening air sources such as inlets) in a power/heating event.

Winch Cards are optional. Users employing an RBU-27 SE do not require Winch Cards. Munters recommends that users employing an RBU-5 or RBU-3 install Winch Cards.

- Platinum Pro Winch Card Relay Wiring
- Rotem One Winch Card Relay Wiring

6.4.1 PLATINUM PRO WINCH CARD RELAY WIRING

NOTE Use relays 7 – 10 for winch card relays. Winch cards are equipped with two Normally Close relays.

1. Connect separate control phase commons for each inlet or curtain.

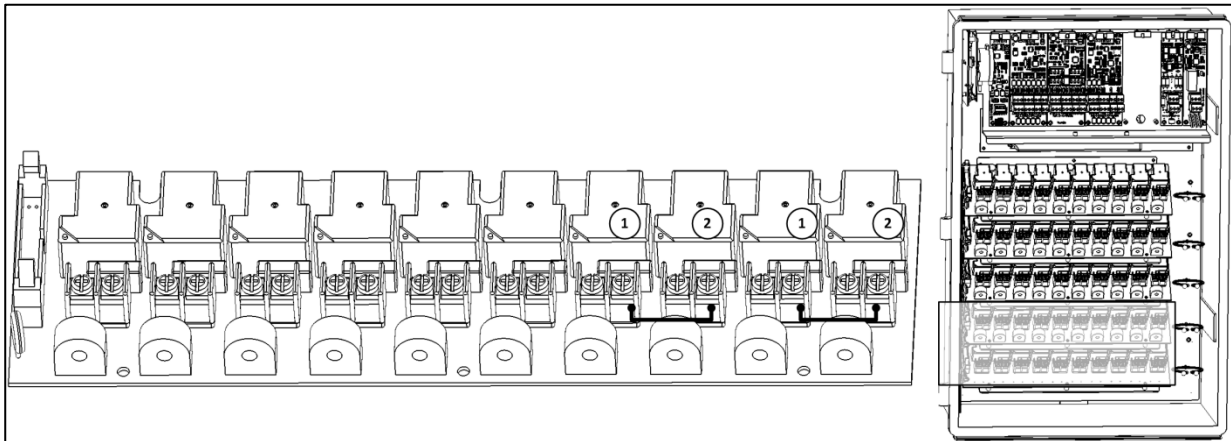

Figure 28: Winch Card Control Phase Commons

Figure 28 key

1	Open curtain (Normally Open Relay)	2	Close curtain (Normally Open Relay)
---	------------------------------------	---	-------------------------------------

2. Connect the output wires to the required device.

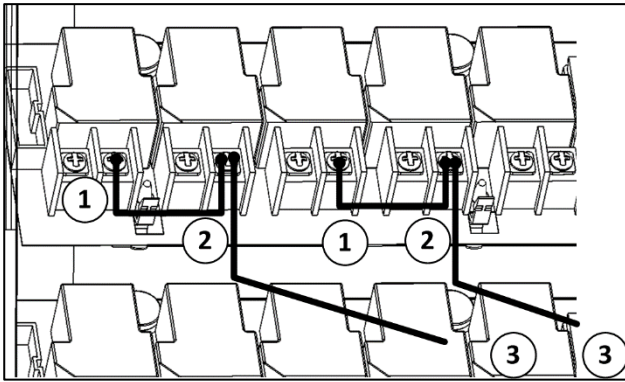

Figure 29: Connecting the Output Wire to Inlets/Curtains

Figure 29 key			
1	Open curtain (Normally Closed (NC) relay is wired to the opening gear)	3	Connect control phase wire to: <ul style="list-style-type: none"> • L1 or L2 power port OR • Backup device
2	Close curtain (Normally Open (NO) relay is wired to the opening gear)		

6.4.2 ROTEM ONE WINCH CARD RELAY WIRING

NOTE Use the relays on the right-hand side only. Winch cards are equipped with two Normally Close relays.

1. Connect separate control phase commons for each inlet or curtain.

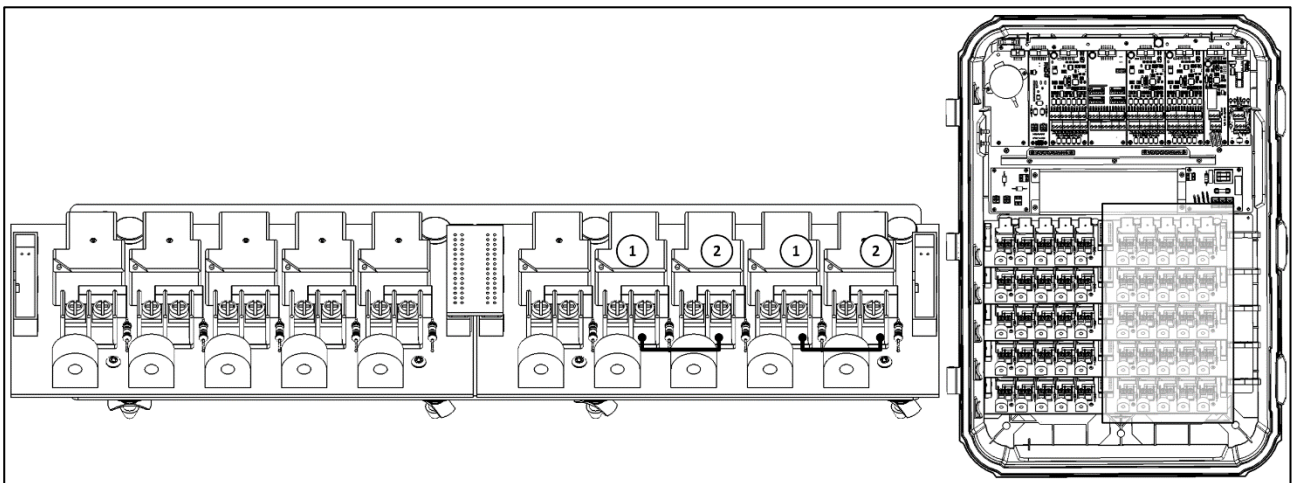

Figure 30: Winch Card Control Phase Commons

Figure 30 key			
1	Open curtain (Normally Open Relay)	2	Close curtain (Normally Open Relay)

2. Connect the output wires to the required device.

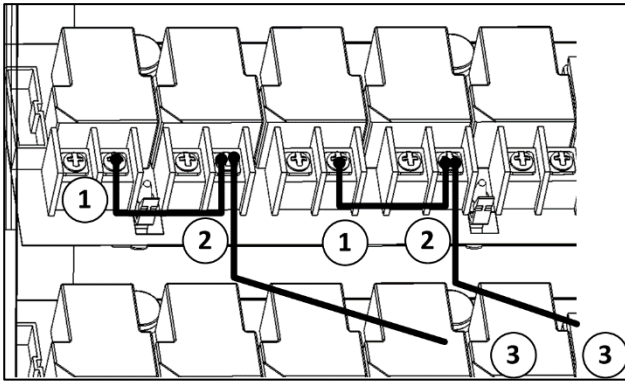

Figure 31: Connecting the Output Wire to Inlets/Curtains

Figure 31 key			
1	Open curtain (Normally Closed (NC) relay is wired to the opening gear)	3	Connect control phase wire to L1 or L2 power port OR RBU device.
2	Close curtain (Normally Open (NO) relay is wired to the opening gear)		

6.5 Completing the Wiring

- Platinum Pro: Tie the cables together with tie wraps and route them as shown (through the high voltage wiring holes drilled as shown in Drilling, page 25).
- Rotem One: Tie the cables together with tie wraps and route them through the knockouts.

7 Low Voltage Wiring

- Analog Input Wiring, page 42
- Weather Station Wiring, page 44
- Digital Input Wiring, page 48
- Analog Output Wiring, page 49
- Alarm Card Wiring, page 50
- Communication Card Wiring, page 51
- RS-485 Termination, page 52

7.1 Analog Input Wiring

Platinum Pro/Rotem One's analog input card (P/N: C-P3-RAIC12) supports up to 12 analog devices: temperature, light, CO₂, and humidity sensors, wind direction detectors, and potentiometers. The analog input cards include surge and lightening protection circuits and do not require additional external protections.

- Use 22 AWG or lower, shielded cable only!
 - Connect every analog input device's shield to the controller's safety ground!
 - Every COM input is correct and more than one sensor can be connected to a COM input.
-
- Analog Card DIP Switches
 - Analog Input Wiring Diagram for Temperature Sensors
 - Analog Input Wiring Diagram for CO₂
 - Analog Input Wiring Diagram for RLS
 - Analog Input Wiring Diagram for Potentiometers
 - Analog Input Wiring Diagram for Humidity Sensors
 - Analog Input Wiring Diagram for Ammonia Sensors

7.1.1 ANALOG CARD DIP SWITCHES

The RAIC-12 has the following ports:

- T1 – T8: Eight dedicated temperature sensor inputs
- IN1 – IN4: Four input ports defined using dip switches
- Four COM ports
- +12V: Two dedicated humidity sensor voltage (12V) ports
- 3.3V: Two dedicated potentiometer voltage (3.3V) ports

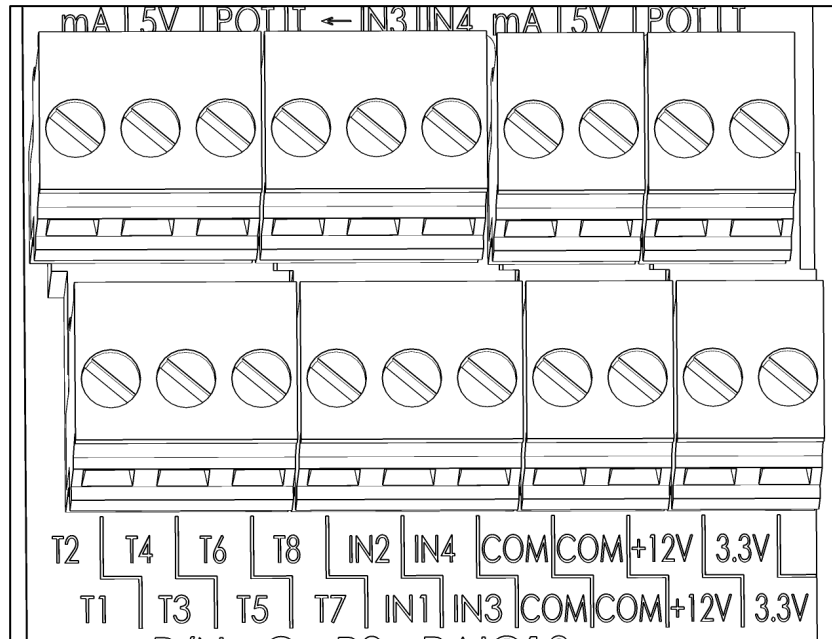

To configure the IN1 – IN4 ports move one dip switch to ON in each set of ports.

CAUTION Leaving all switches in the Off position or placing more than one switch in the On position in a set nullifies those functions!!

- DIP Switch 1: 4 – 20 mA (CO2 and light sensors)
- DIP Switch 2: 0 – 5V (humidity)
- DIP Switch 3: Potentiometer and wind direction sensors
- DIP Switch 4: Temperature sensor

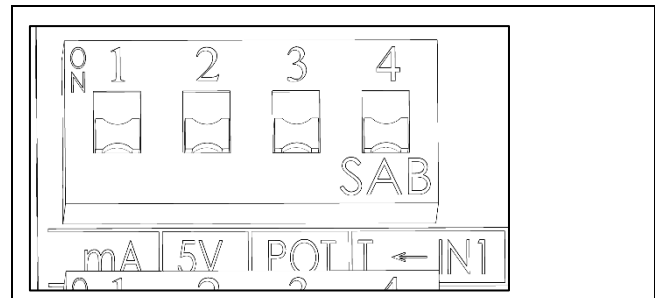

7.1.2 ANALOG INPUT WIRING DIAGRAM FOR TEMPERATURE SENSORS

Refer to the [RTS-2 Manual](#) for details on this sensor

- Connect the temperature sensor to an input and COM port. Terminals 1 - 8: These inputs support temperature sensors only.
- IN1 – IN4: These are optional temperature sensor inputs (turn DIP Switch 4 (T) on each set as required).

Figure 32 shows an example of temperature sensor wiring.

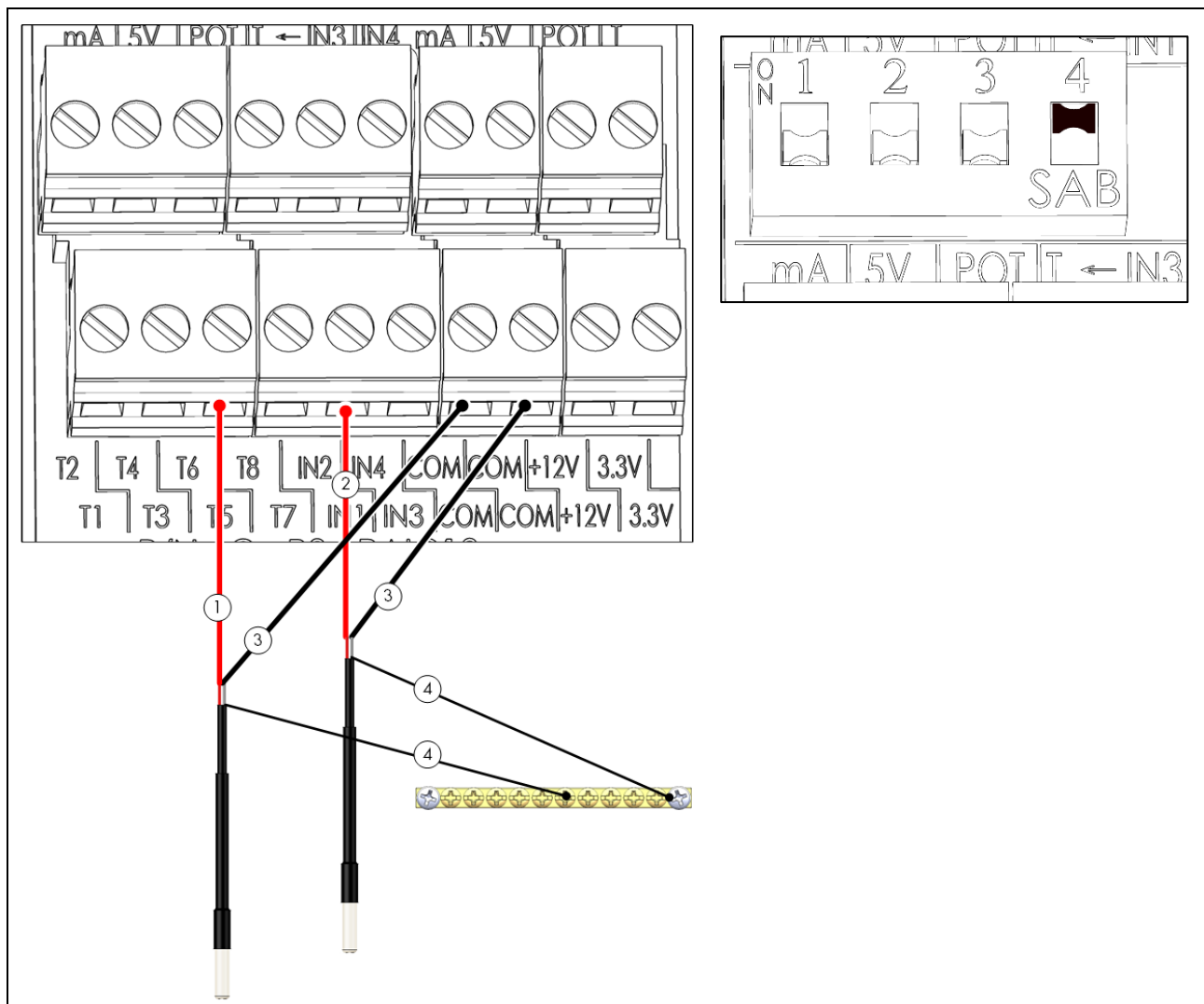

Figure 32: Temperature Sensor Wiring and IN Dipswitch

Figure 32 key	
1	T input
2	IN input
3	COM ports
4	Shield wire connected to grounding strip

7.1.3 ANALOG INPUT WIRING DIAGRAM FOR CO2

Refer to the [CO2 Sensor Manual](#) for details on installing this unit.

1. Connect each sensor to an input and COM port.
2. IN1 – IN4: Turn DIP Switch 1 of the corresponding channel.

Figure 33 shows an example CO2 wiring.

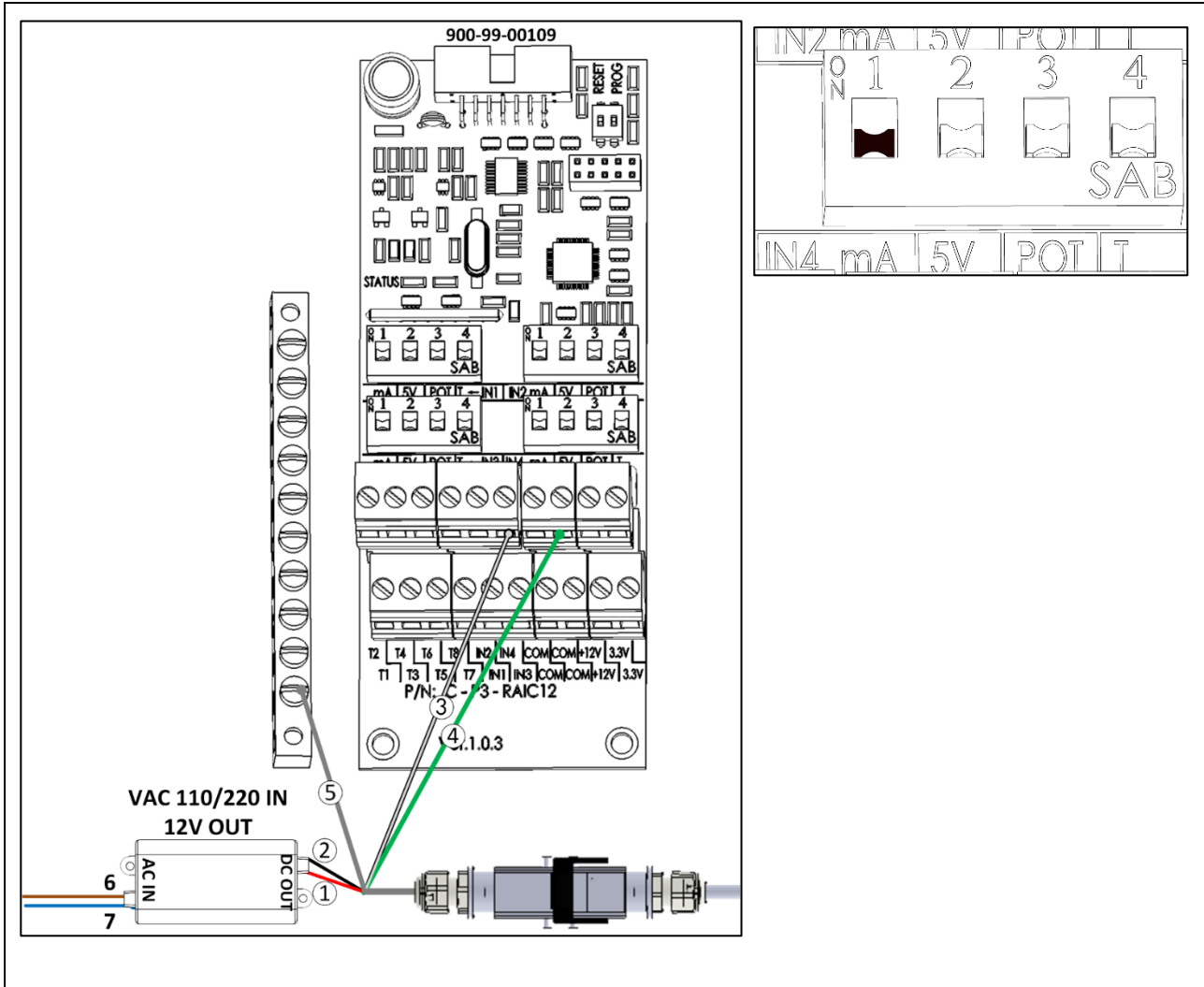

Figure 33: CO2 Sensor Wiring and IN Dipswitch

Figure 33 key			
Number	Function	Number	Function
1	Red wire: +12V	6	Brown wire: phase
2	Black wire: -12V (Sig COM)	7	Blue wire: neutral
3	IN 1 to IN 4		
4	COM port		
5	Shield wire		

CAUTION Connect the shield to the safety ground.

7.1.4 ANALOG INPUT WIRING DIAGRAM FOR RLS

Refer to the [RLS Manual](#) for more information

1. Connect the sensor to an input and 12V ports.
2. IN1 – IN4: Turn DIP Switch 1 of the corresponding channel.

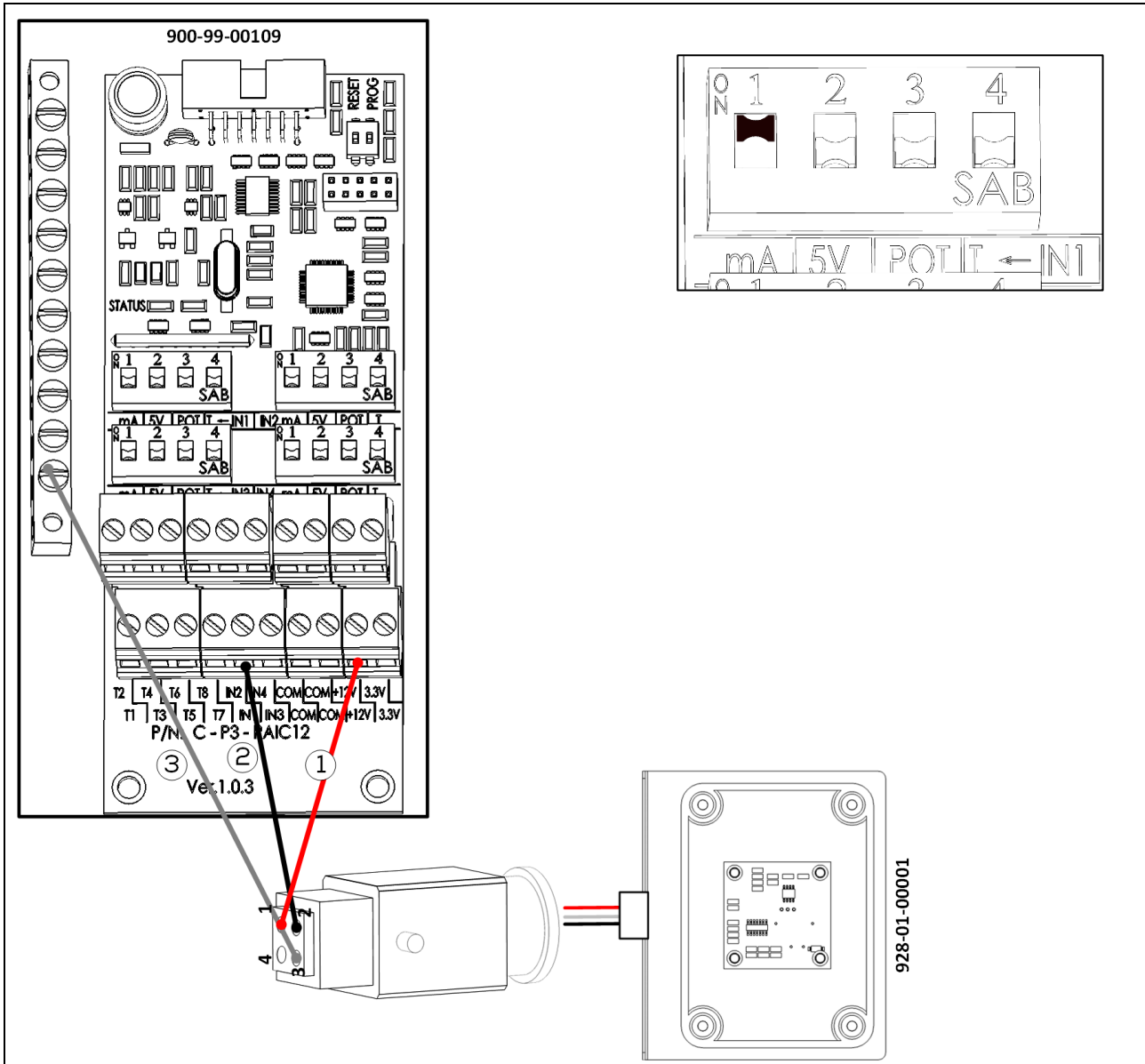

Figure 34: Light Sensor Wiring and IN Dipswitch

Figure 34 key	
1	Red wire (+12V)
2	Black wire (IN1 – IN4)
3	Shield wire connected to grounding strip

CAUTION Connect the shield to the safety ground.

7.1.5 ANALOG INPUT WIRING DIAGRAM FOR POTENTIOMETERS

1. Connect each potentiometer (10 - 20 KOhm) to an input, a COM, and 3.3V port.
2. IN1 - IN4: Turn DIP Switch 3 (POT) on each set as required.

Figure 35 shows an example potentiometer wiring.

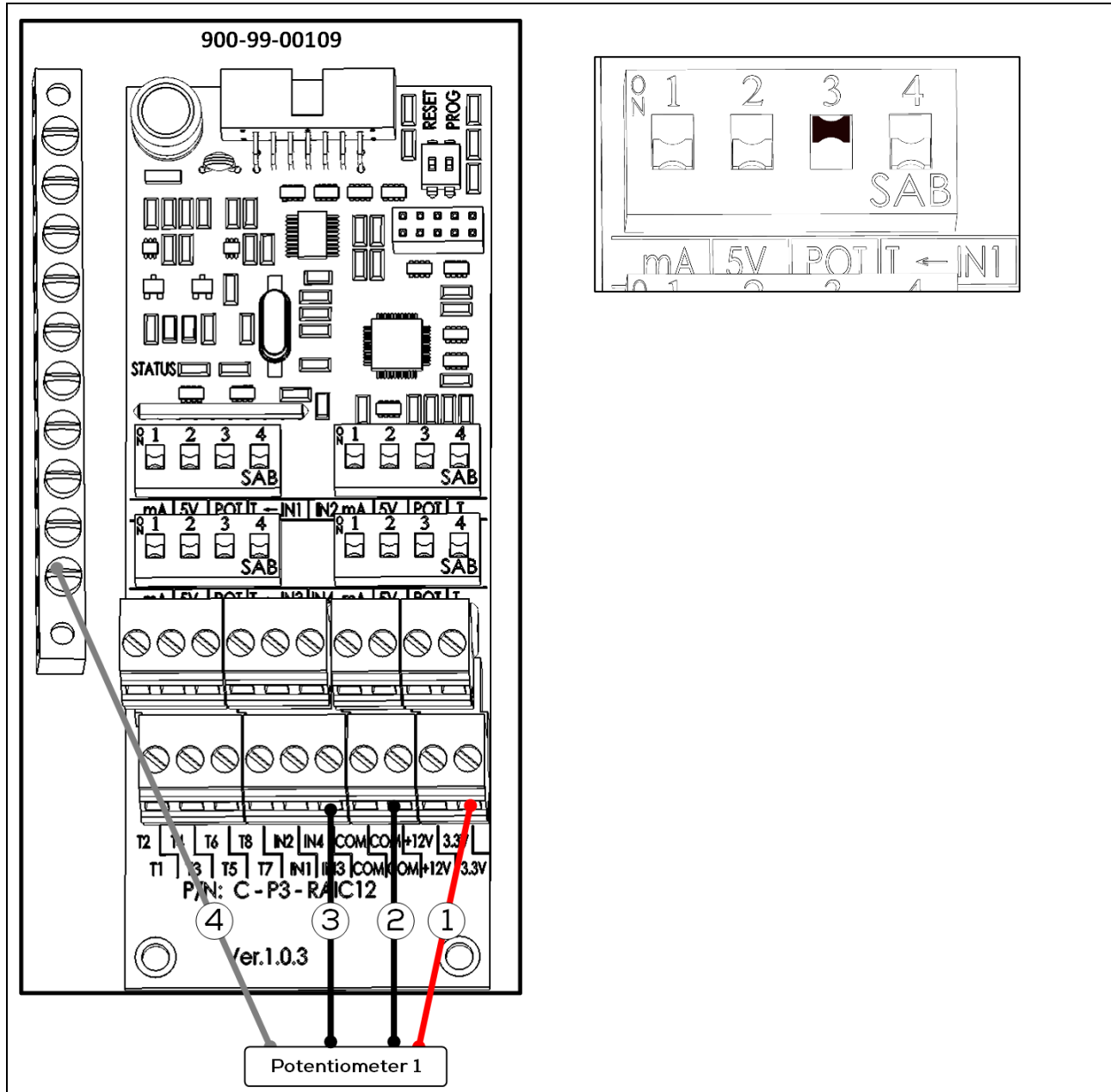

Figure 35: Potentiometer Wiring

Figure 35 key			
1	3.3V	3	IN1 - IN4
2	COM	4	Shield wire connected to grounding strip

7.1.6 ANALOG INPUT WIRING DIAGRAM FOR HUMIDITY SENSORS

Refer to the [RHS Pro Manual](#) for further information.

1. Connect each humidity sensor to input, a COM, and +12V port.
2. IN1 – IN4: Turn DIP Switch 2 on each set as required.

Figure 36 shows an example humidity sensor wiring setup.

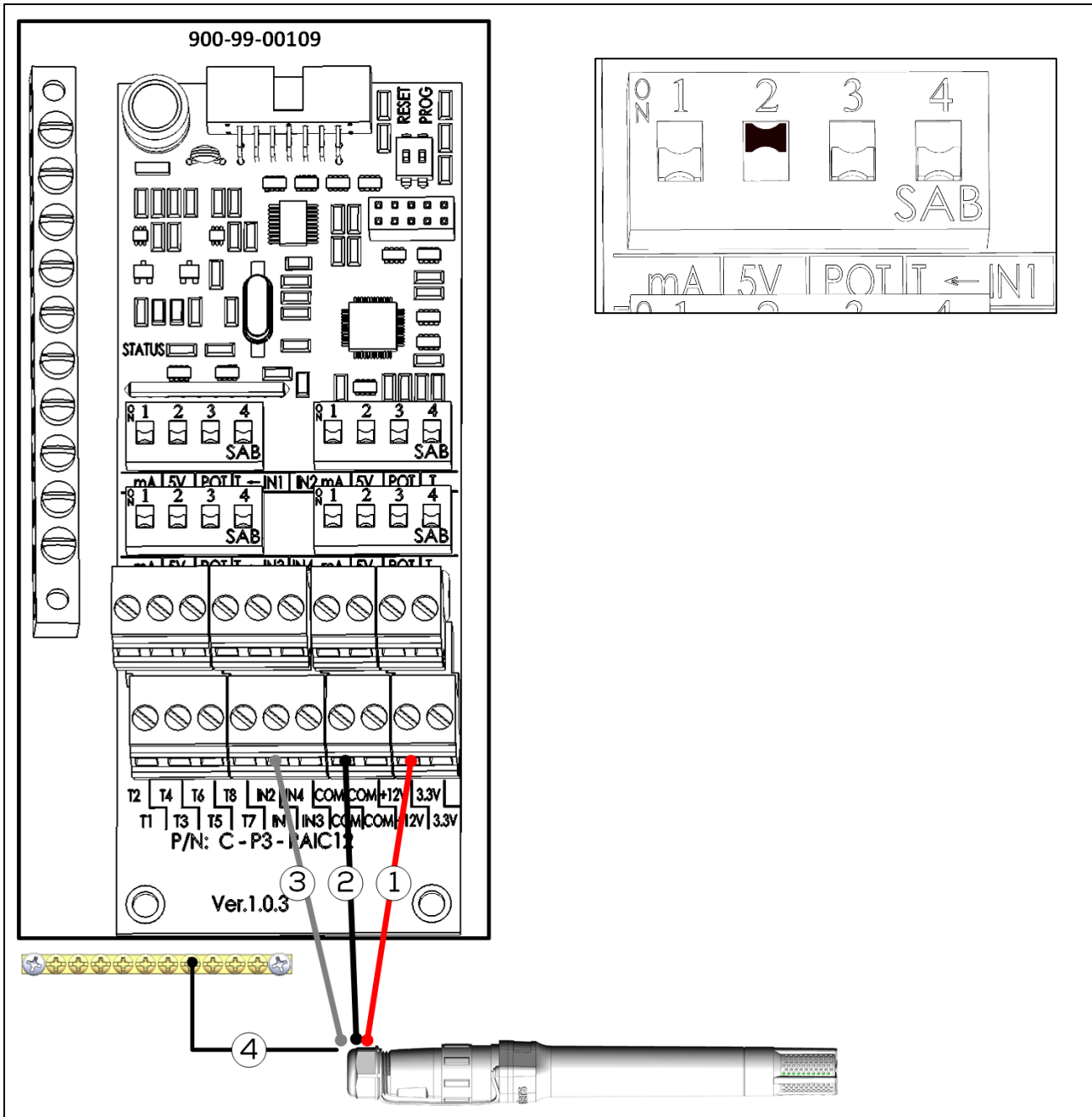

Figure 36: Humidity Sensor Wiring

Figure 36 key			
1	Red wire (+12V)	3	White wire (IN1 – IN4)
2	Black wire (COM)	4	Shield wire connected to grounding strip

CAUTION Connect the shield to the safety ground.

7.1.7 ANALOG INPUT WIRING DIAGRAM FOR AMMONIA SENSORS

Refer to the [Ammonia Sensor manual](#) for further information.

1. Connect:

- Sensor green wire to power supply black wire. Connect the combined wire to COM.
- Sensor white wire (24VDC power source) to power supply red wire (24V).
- Sensor brown wire:
 - Connect the wire to a 10 kohm resistor.
 - Connect the resistor to port IN1, IN2, IN3, or IN4.

2. On the Analog Input Card, set the corresponding dipswitch to the 5V position (DIP switch 2).

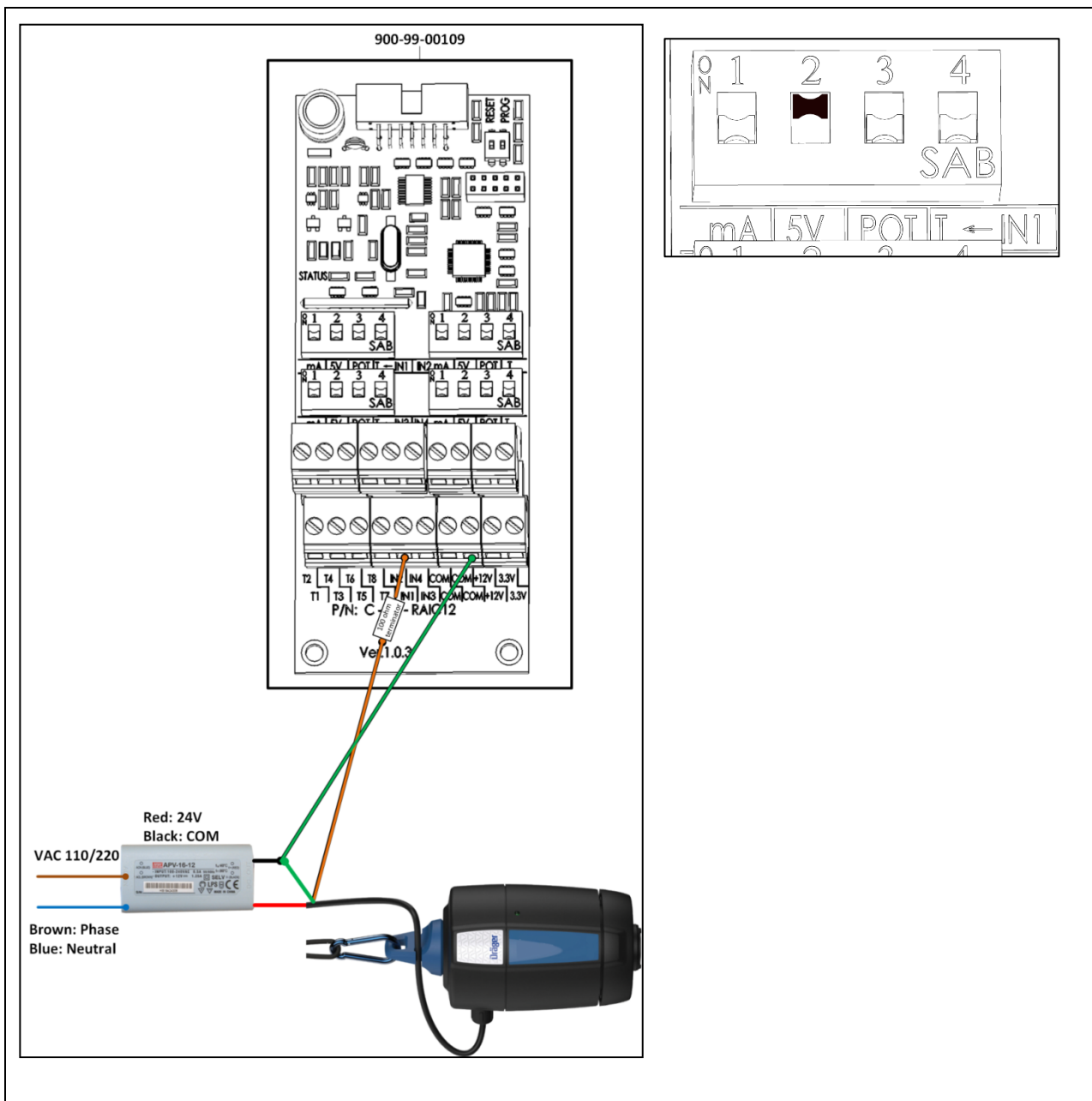

Figure 37: Ammonia Sensor Wiring and IN Dipswitch

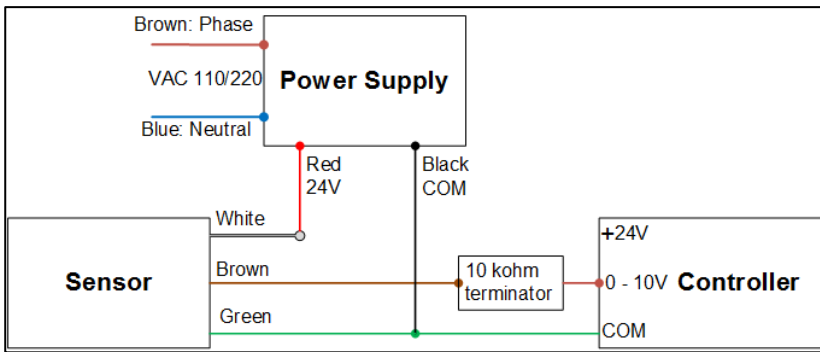

Figure 38: Ammonia Sensor Schematic

7.2 Weather Station Wiring

Setting up a weather station (rain and wind direction sensor) requires the following wiring:

1. Wind direction sensor (P-WS-WDS) to RAIC-12:
 - a. Connect each wind direction sensor to an input, a COM, and POT port.
 - b. IN1 – IN4: Turn DIP Switch 3 on each set as required.
2. Wind direction sensor to RDIC-12:
 - Connect each wind direction sensor to an input and a COM port.
3. Rain Sensor (P-WS-WRS) to RDIC-12:
 - Connect each sensor to an input and a COM port.

Figure 39 shows the two cards wired to the components; Figure 40 and Figure 41 show the wiring in greater detail.

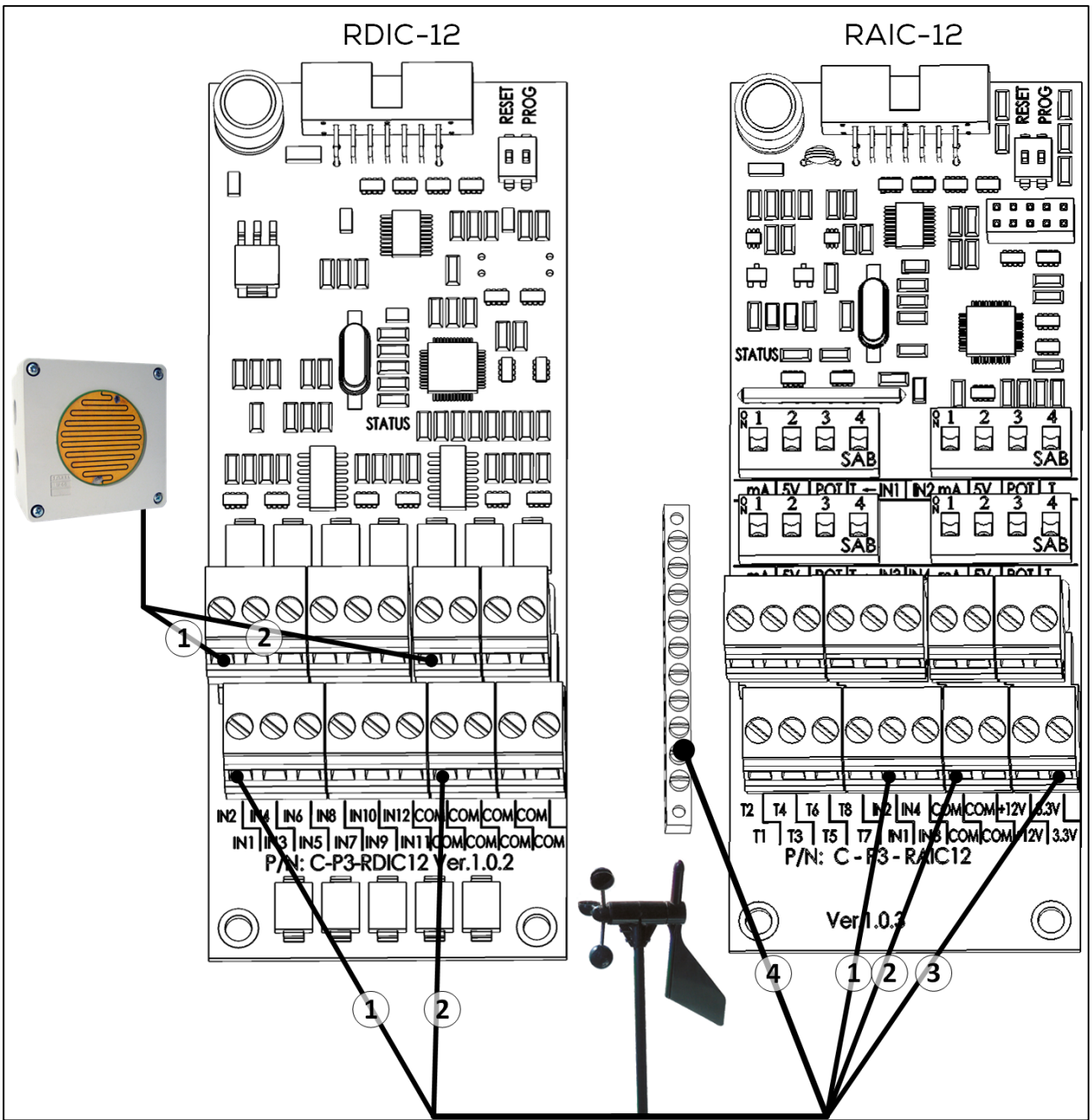

Figure 39: Weather Station Wiring

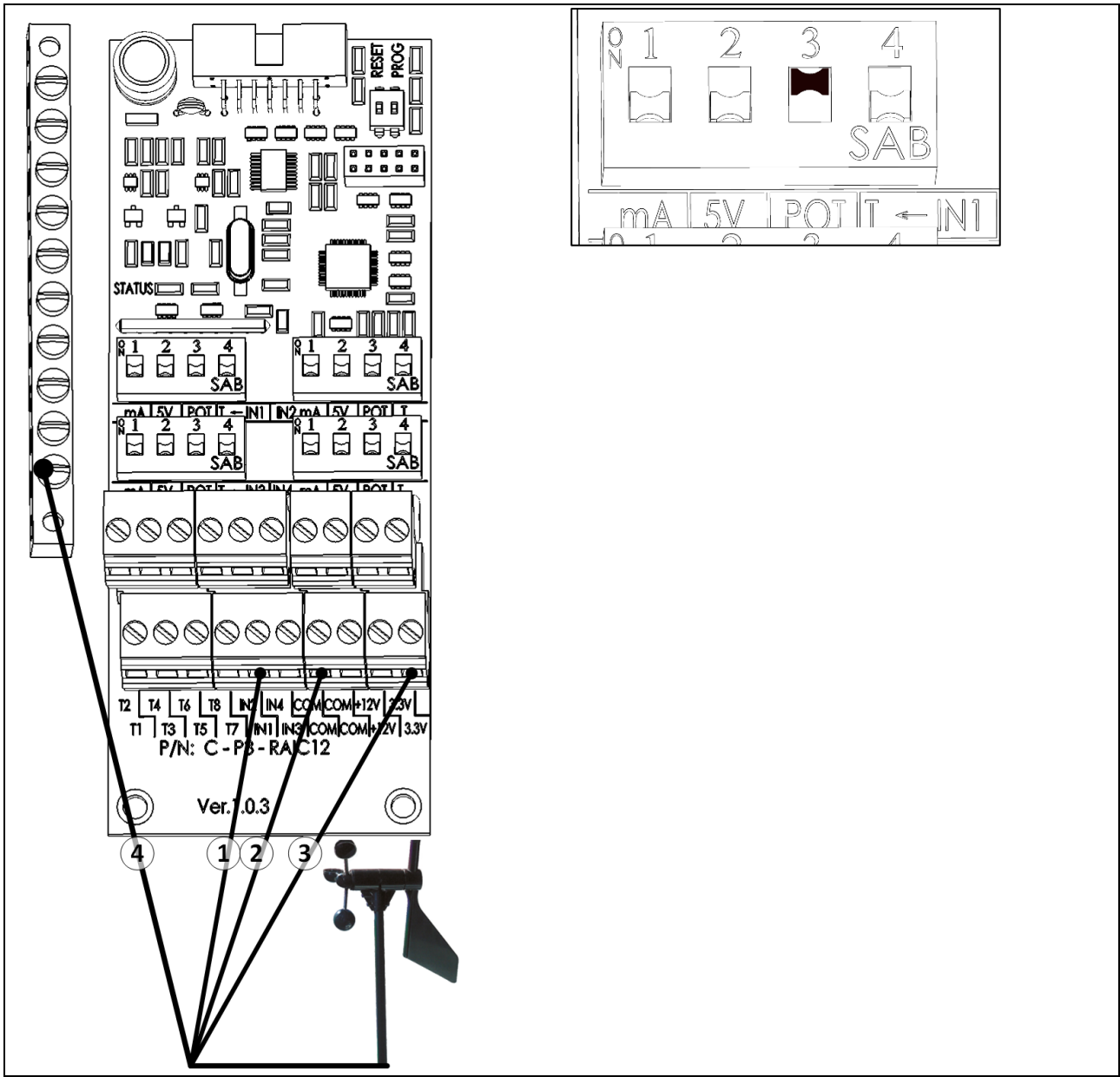

Figure 40: Weather Station Analog Input Card and IN Dipswitch

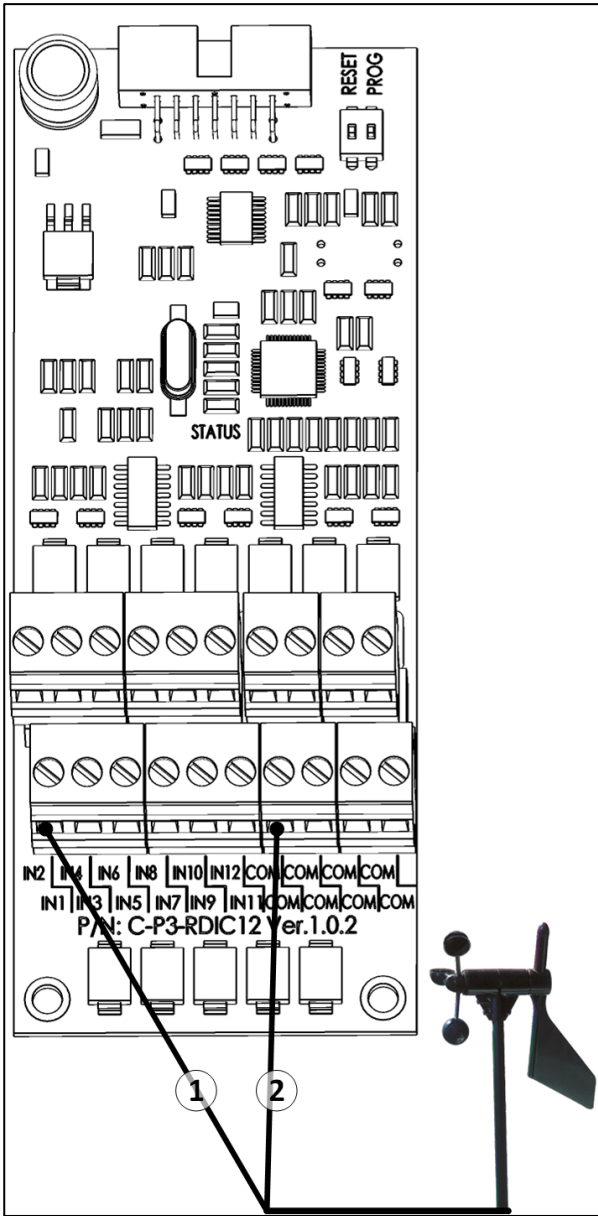

Figure 41: Weather Station Digital Input Card

NOTE If the Speed Sensor is not used, connect the red wire to the COM entry of the Analog Input Card.

Figure 39 / Figure 40 / Figure 41 key	
1	IN port
2	COM
3	3.3 volts
4	Ground strip

7.3 Digital Input Wiring

Platinum Pro/Rotem One has a Digital Input Card (P/N: C-P3-RDIC12) with 12 inputs which are used to measure digital sensors. Each input requires an input and COM port.

- It is possible to connect the common of several sensors to the same connector. However, Munters recommends spreading the commons in an even manner.
- The Digital Input Card includes surge and lightning protection circuits and does not require external protections.

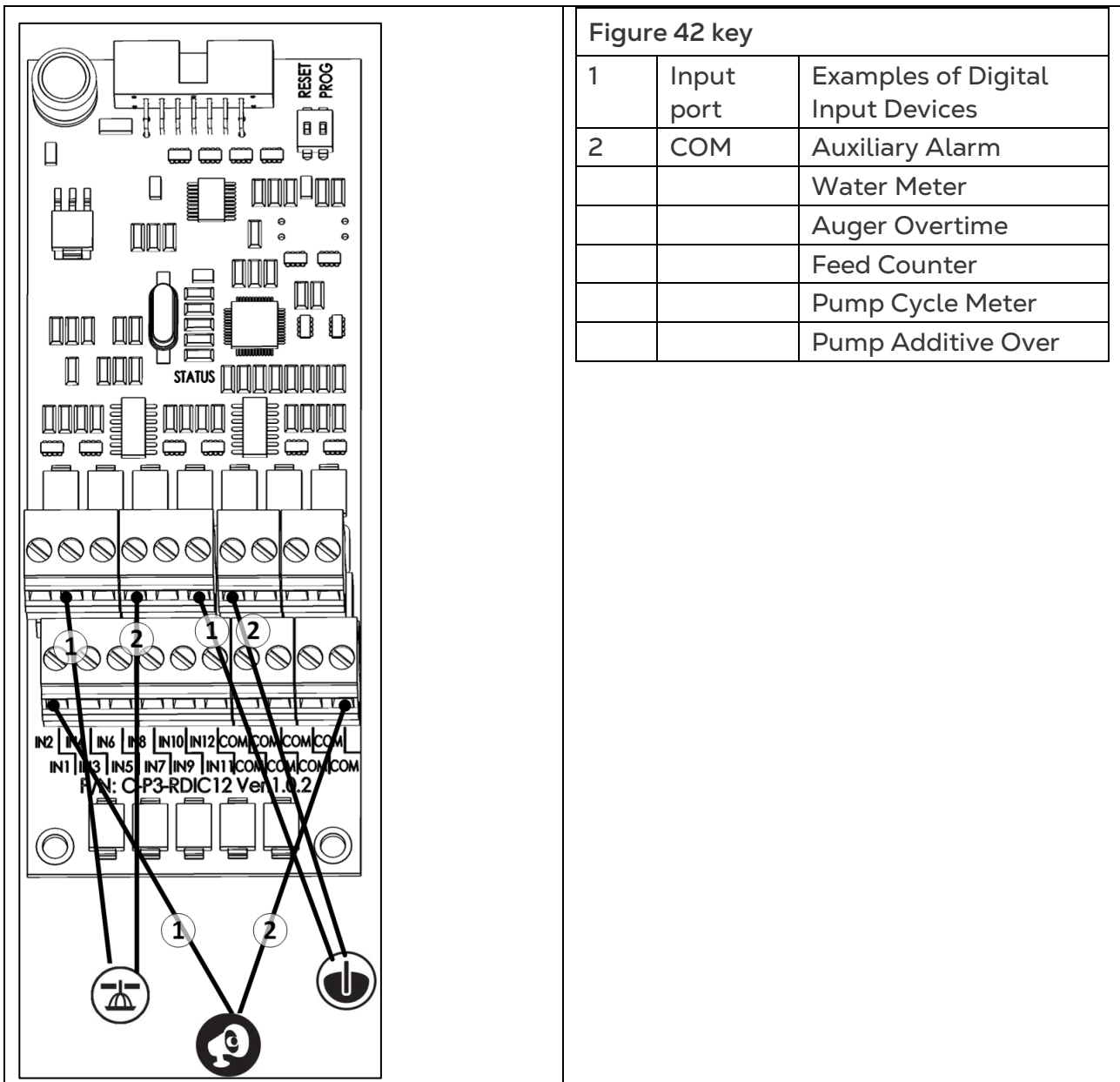

Figure 42: C-P3-RDIC12 Wiring (Example)

7.4 Analog Output Wiring

Rotem One has an Analog output card (C-P3-RAOC10) with 10 outputs used to drive external units controlled by 0 – 10 VDC. The analog outputs card consists of surge and lightning protection circuits and does not require external protections.

CAUTION Connect every analog output device's shield to the controller's safety ground!

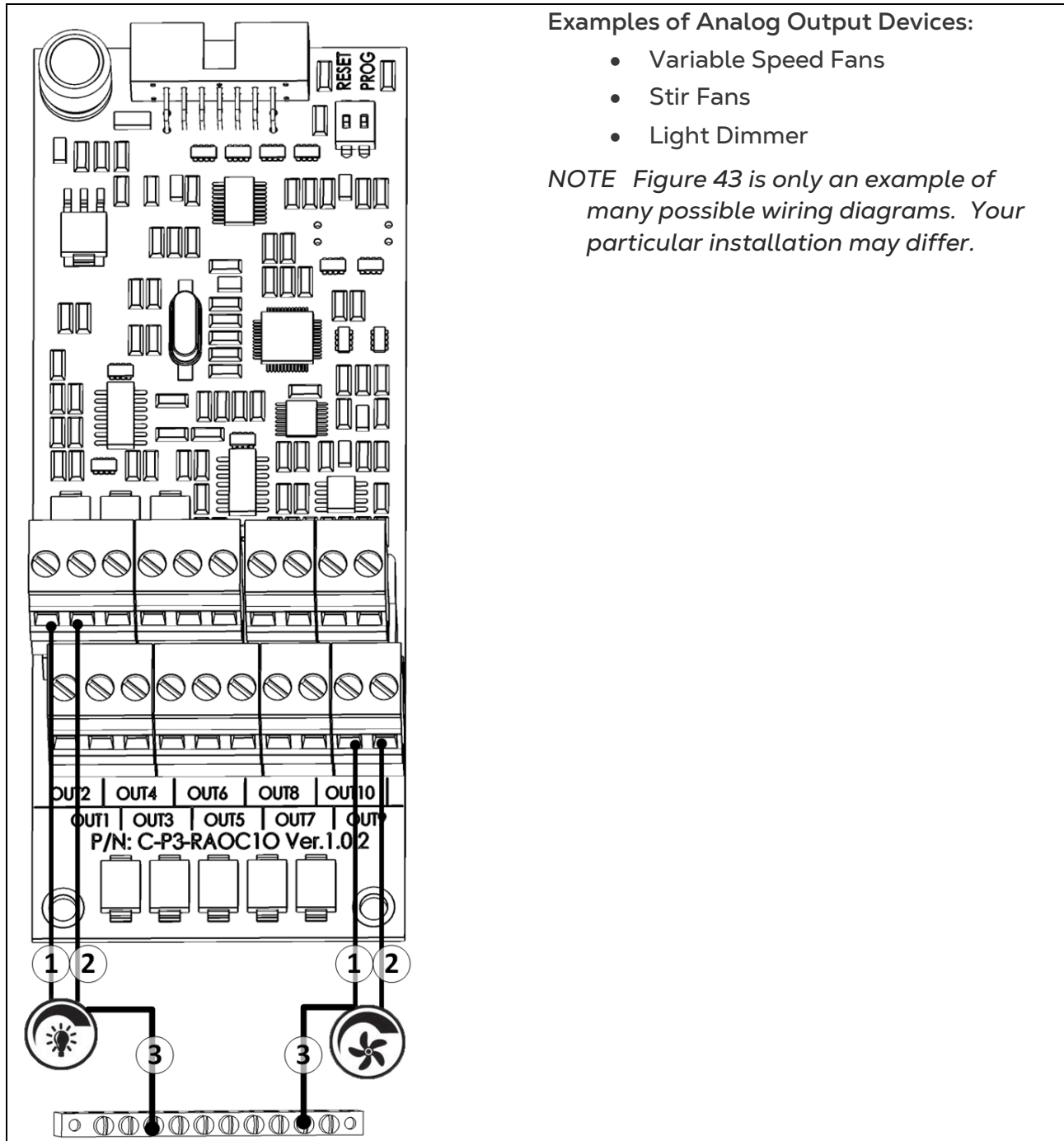
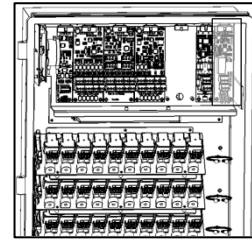

Figure 43: C-RAOC12 Wiring (Example)

1	0-10V port
2	COM port
3	Ground strip

7.5 Alarm Card Wiring

Munters' Alarm Card (C-PP-P3-ALARM) provides integrated lightning protection for a single alarm device of up to 430 Volts DC. If you need to protect more than one device, use Munters' P-RLVP to protect low voltage devices or the RPLP for line voltage devices.



Suggested Alarm System Connection: To provide lightning protection to the alarm:

- Connect wiring of products requiring protection into the ports labeled "Protected input".
- Connect wiring of products not requiring protection into the ports labeled "Unprotected input".

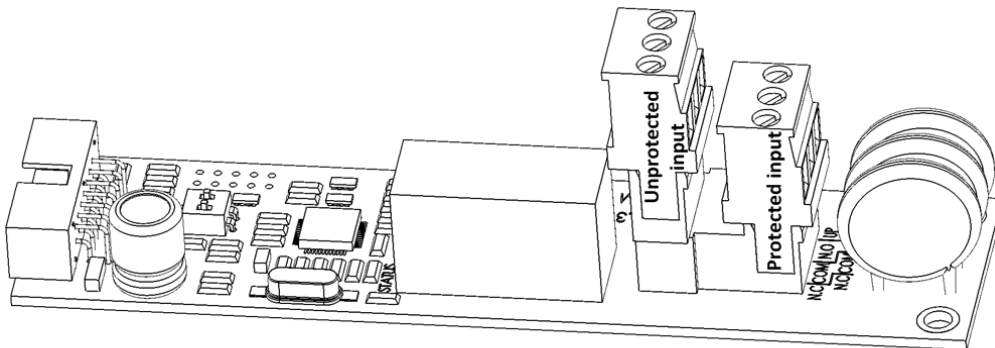

C-P3-ALARM

Figure 44: Unprotected Input/Protected Input

The alarm card provides NO (Normally Open) and NC (Normally Closed) connections on two independent terminals.

- NC connections are open
- NO connections are closed. This feature provides automatic power fail alarms if the system loses power to the alarm card.

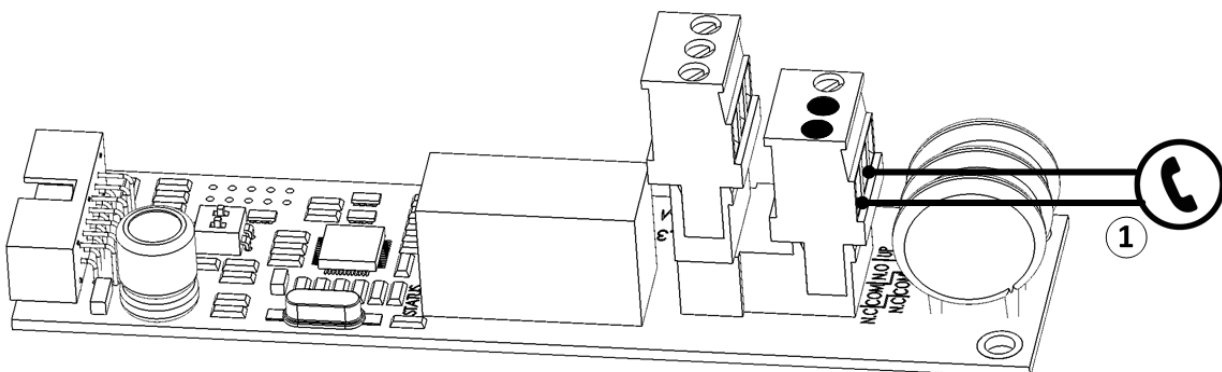

C-P3-ALARM

Figure 45: Normally Close Alarm System Wiring

Figure 45 key

1	12V dialer
---	------------

You can use the protection for other devices such as a simple siren.

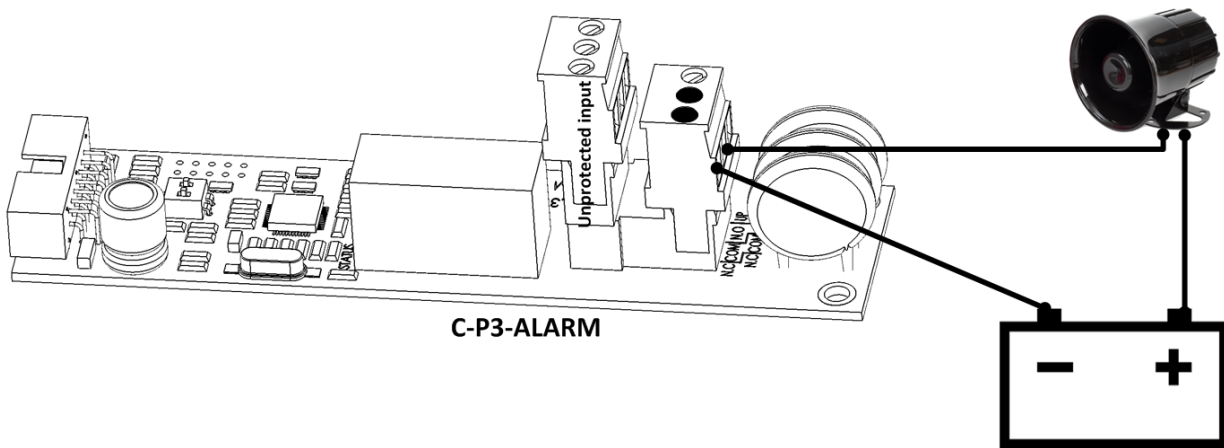

Figure 46: C-P3 Siren Wiring Diagram

Figure 46 key

- | | |
|---|-------------|
| 1 | 12V battery |
|---|-------------|

NOTE If you need to protect more than one device, use Munters' P-RLVP to protect low voltage devices or the RPLP for line voltage devices.

7.6 Communication Card Wiring

The communication option provides a means to connect a personal computer locally or remotely by modem. Connection to the computer is via a communication device. Figure 4 (page 20) shows the communication card location.

- RS-232 Card: 900-99-0012

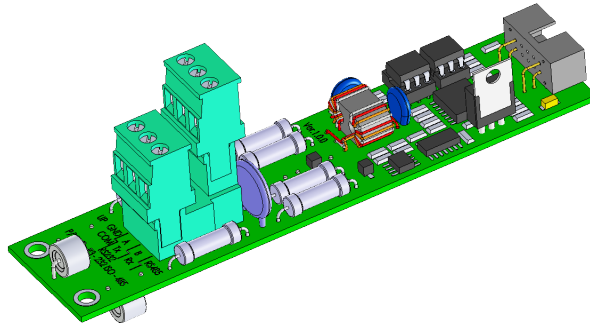

- RS-485 Card: 900-99-00101

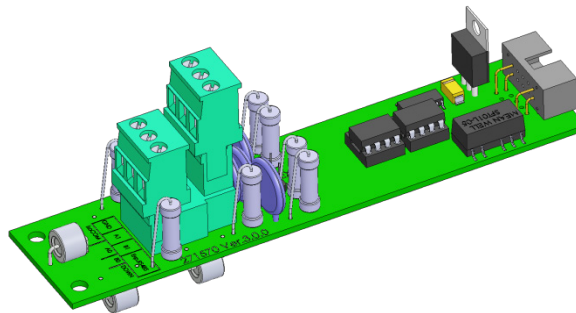

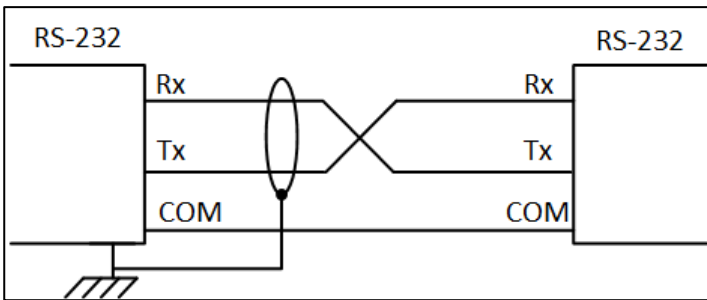

Figure 47: RS-232 Wiring

CAUTION Cross the TX-RX wiring!

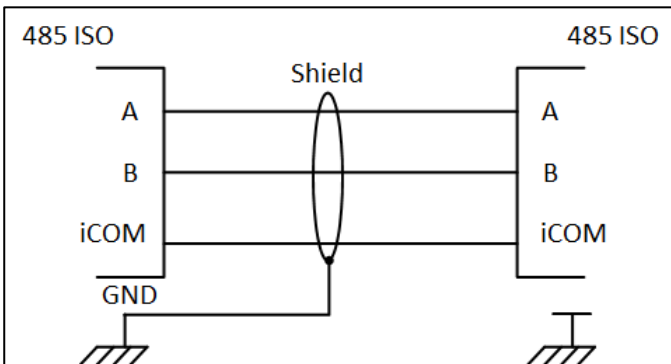

Figure 48: RS-485 Wiring

CAUTION Connect the ground shield on one side only! NEVER connect the communication COM to the power ground!

7.7 RS-485 Termination

When installing Platinum Pro/Rotem One units and connecting them to other devices, ensure that there is proper electrical termination. The following section details how and what to terminate.

- Controllers and Comm-Box
- Controllers and Communicator
- Controller, Relay Expansion, RSU-2 and HUB
- Placing the Terminator

7.7.1 CONTROLLERS AND COMM-BOX

- Comm-Box and Controller RS-485 communication cards come equipped with an onboard 120 Ohm termination resistor.
- There is no need to install an external 120 Ohm termination resistor in the controller; place a jumper on the communication card at the unit located at the end of chain (Figure 49).

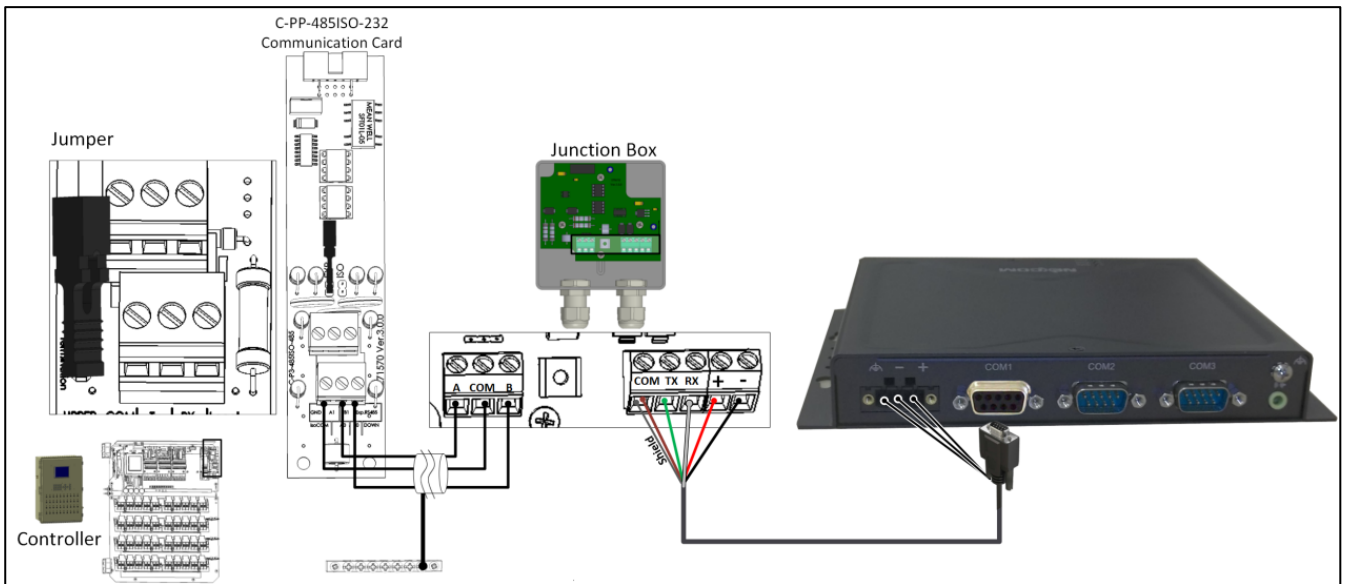

Figure 49: Comm-Box – Controller Termination

7.7.2 CONTROLLERS AND COMMUNICATOR

Refer to Figure 50.

- The controller RS-485 communication card comes equipped with an onboard 120 Ohm termination resistor.
- Place a Jumper on the controller RS-485 communication card at the unit located at the end of chain.
- If the Communicator External Box is located at the end of a chain, install a 120 Ohm termination resistor (supplied by Munters).

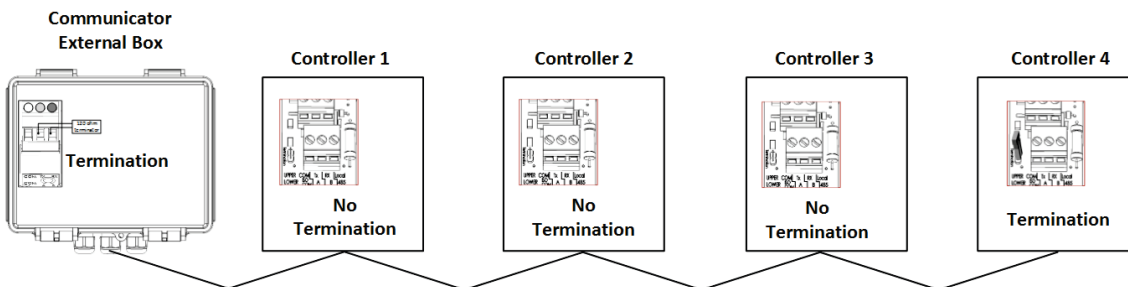

Figure 50: External Box – Controller Termination

7.7.3 CONTROLLER, RELAY EXPANSION, RSU-2 AND HUB

- The controller RS-485 communication card comes equipped with an onboard 120 Ohm termination resistor.
- Place a Jumper on the controller RS-485 communication card at the unit located at the end of chain.
- If an Expansion unit is installed at the end of a chain, install a 120 Ohm termination resistor (supplied by Munters) (Figure 51).

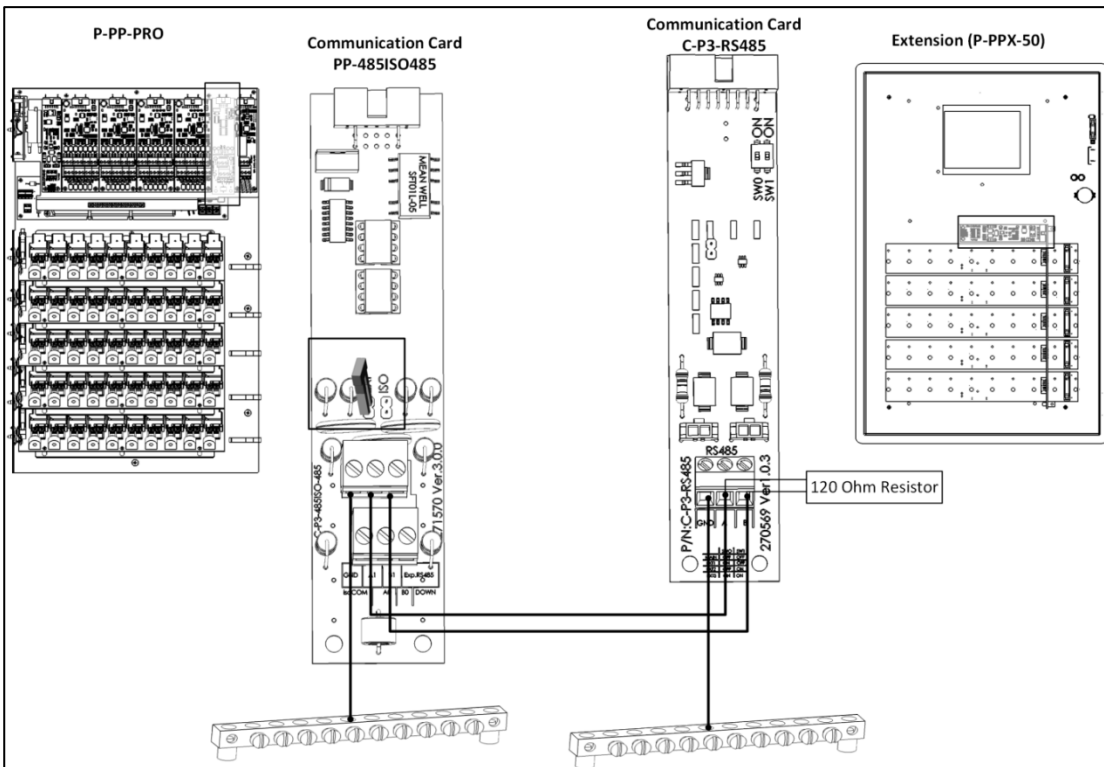

Figure 51: Expansion Box – Controller Termination

- If an RSU unit is installed at the end of a chain, install a 120 Ohm termination resistor (supplied by Munters) (Figure 52).

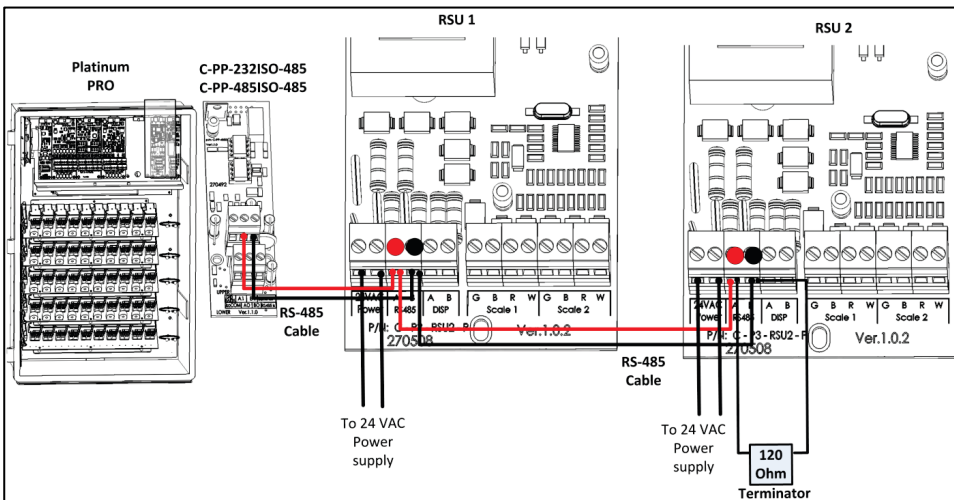
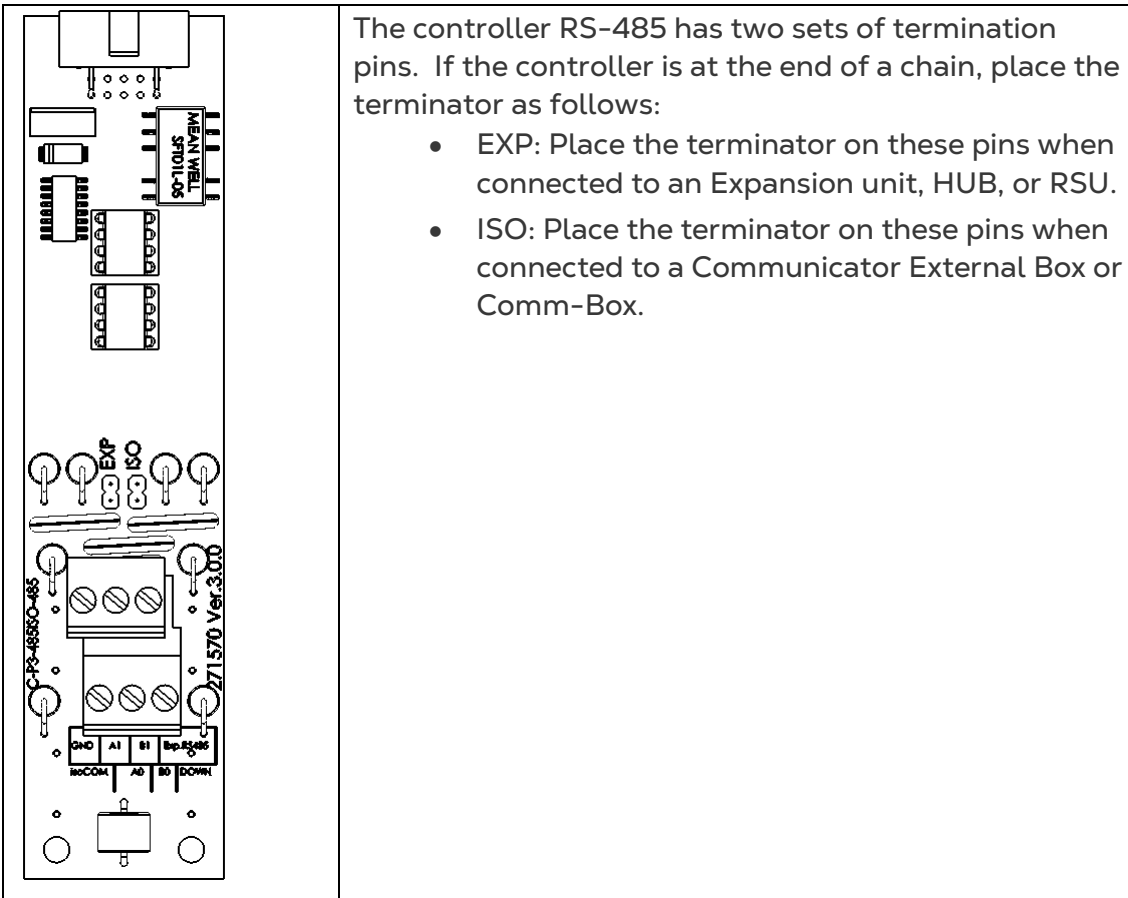

Figure 52: RSU – Controller Termination

- Additional notes:
 - If a HUB is at the end of a chain, place a jumper on the termination pins.
 - 120 Ohm termination resistor part number: 999-99-00333 "RES50 0.12K 1/4W 50PPM 5%"

7.7.4 PLACING THE TERMINATOR



Remember, a controller can be at the end of one chain, but in the middle of a second chain.

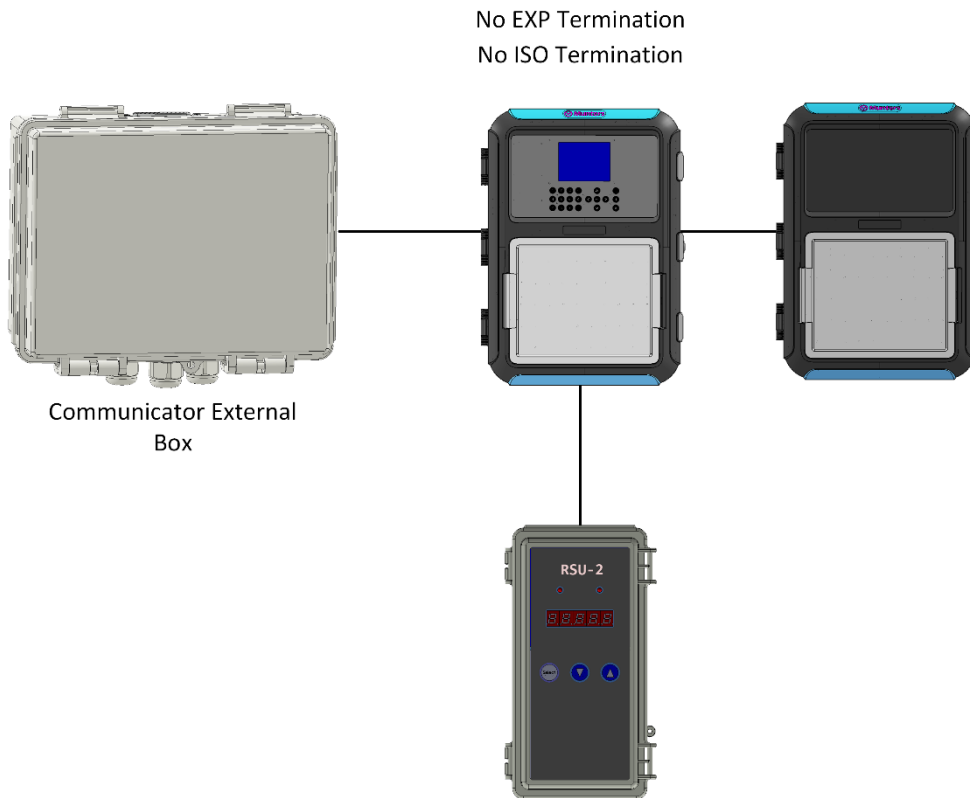

No EXP Termination
ISO Termination

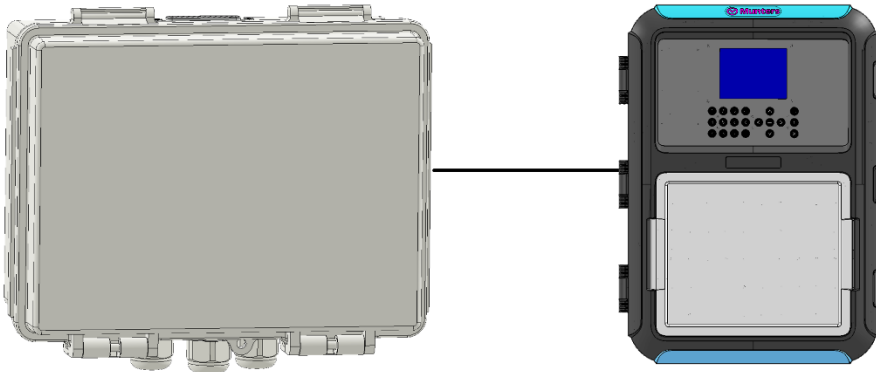

Communicator External
Box

EXP Termination
ISO Termination

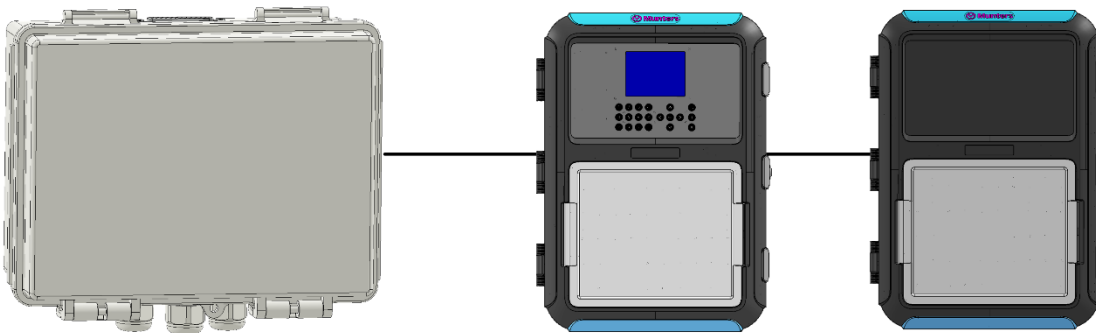

Communicator External
Box

Figure 53: Termination examples

8 Scale Card Wiring

Version 6.18 supports a scale card.

Note: There are two versions of the P3-RSC card:

- Two channel scale cards: Supports up to two bird scales only
- Six channel scale cards: Supports bird, silo, and feed scales

8.1 Bird Scale Wiring

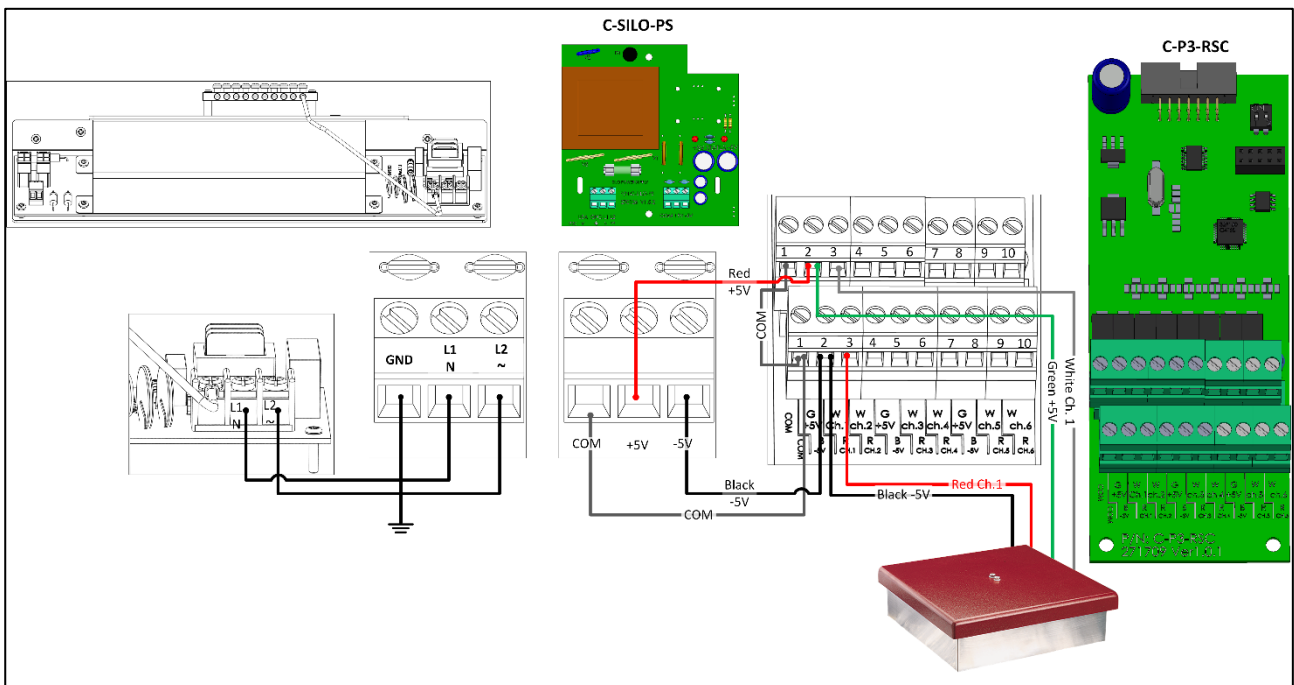
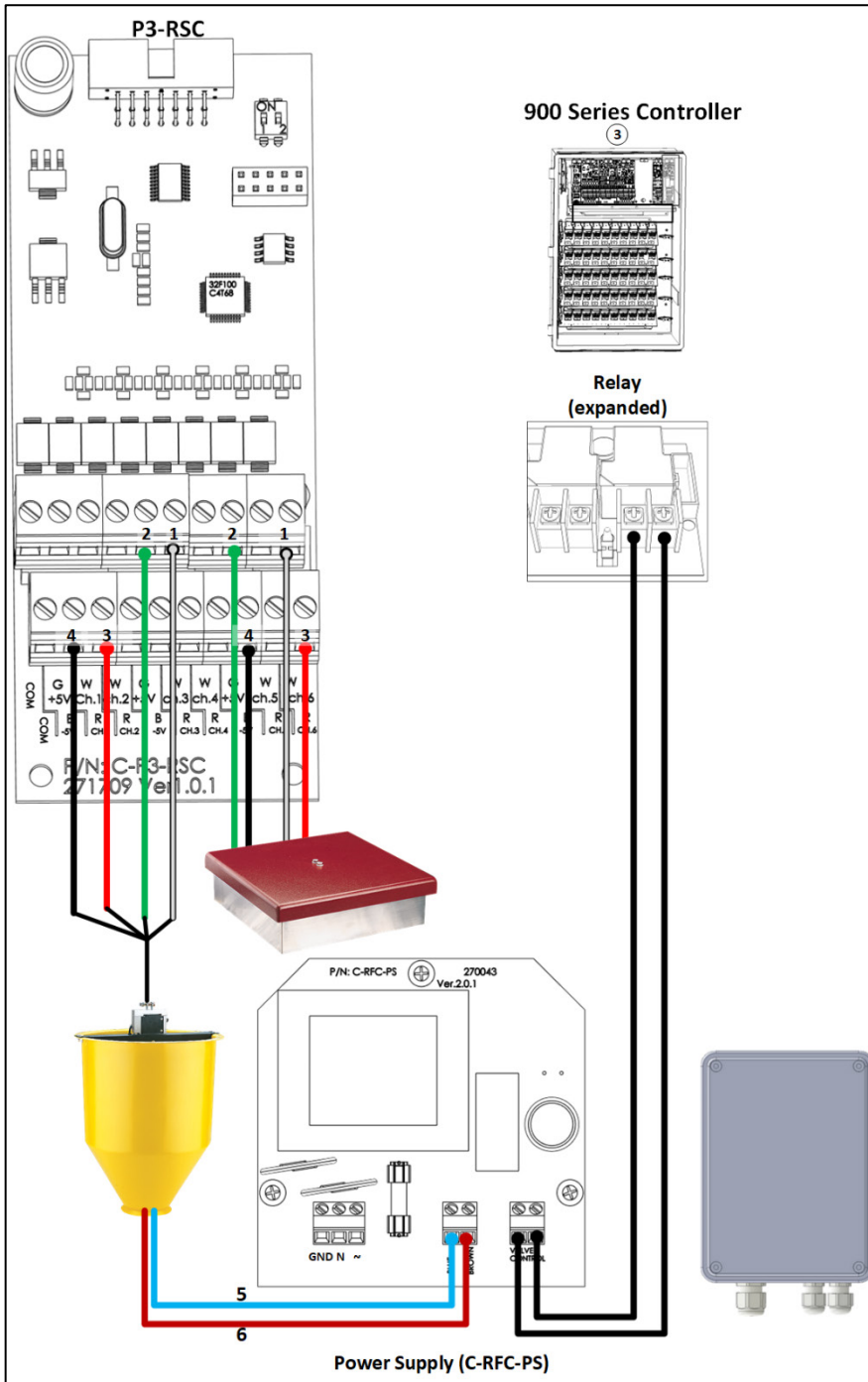

Figure 54: Bird Scale Wiring Diagram

8.2 Feed Scale Wiring



1	White wire	4	Black wire
2	Green wire	5	Blue wire
3	Red wire	6	Brown wire

Figure 55: Feed Scale Wiring Diagram

8.3 Silo Scale Wiring

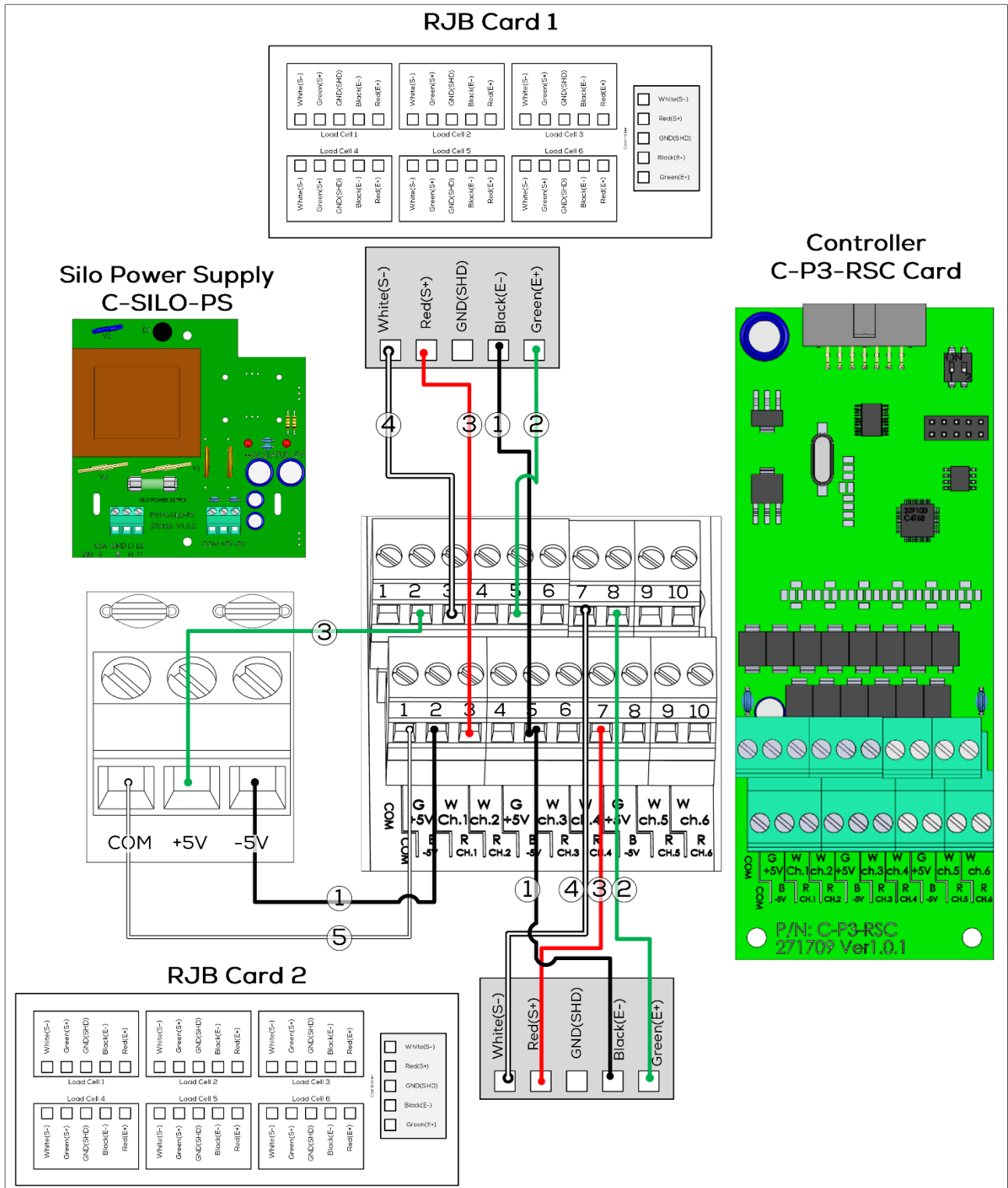

Figure 56: Silo Scale Wiring Diagram

RJB Wire	RSC Ports
Green	2, 5, 8 (Upper)
Black	2, 5, 8 (Lower)
White	3, 4, 6, 7, 9, 10 (Upper)

Red	3, 4, 6, 7, 9, 10 (Lower)	Note: Connect each RJB white and red wire to matching ports. For example White Ch.1 and Red Ch.1
-----	---------------------------	--

9 Appendix A: Platinum Pro Metal Assembly

The Platinum Pro and Touch metal assembly consists of two elements, connected by flat ribbons:

- Front door
- Relay / card panel

- Metal Assembly Precautions
- Panels
- Panel Dimensions
- Mounting the Panels
- Connecting the Metal Panels

9.1 Metal Assembly Precautions

Ensure the following:

- The setup meets electrical, mechanical and fire enclosure requirements.
- Clearance and creepage distances are maintained.
- Grounding meets industry standards.
- Ambient temperatures do not go above product requirements (50° C).

9.2 Panels

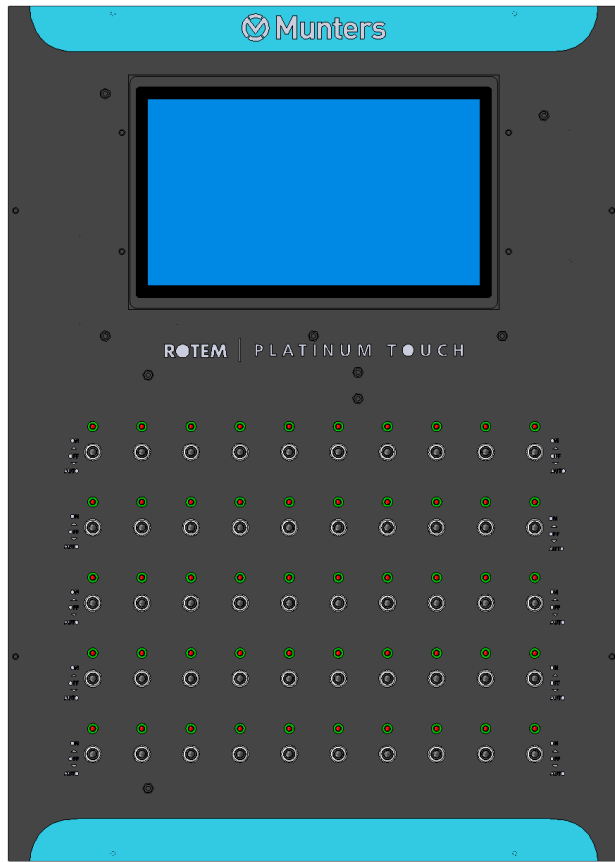

Figure 57: Platinum Pro 50 Front Panel

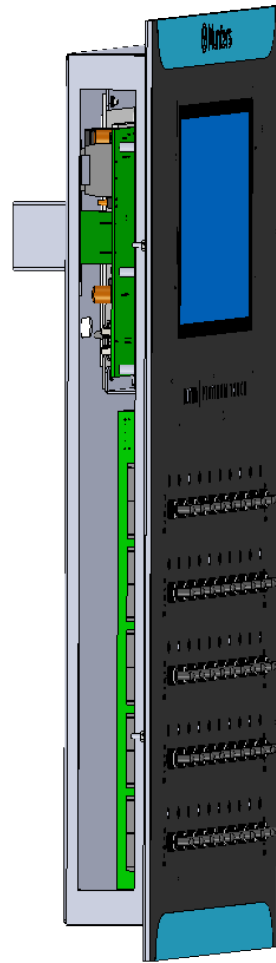

Figure 58: Platinum Pro 50 Side View

9.3 Panel Dimensions

Panel Mounts support up to 30 or 50 relays (depending on the model). Panel dimensions are independent of the number of relays installed in that unit.

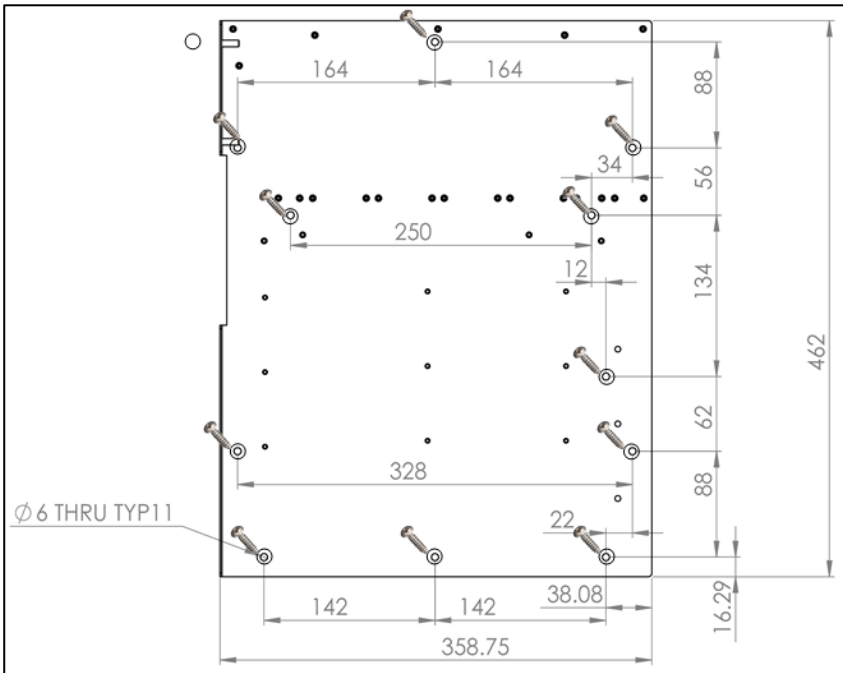

Figure 59: Platinum Pro 30 and Platinum Touch 30 Back Panel Dimensions

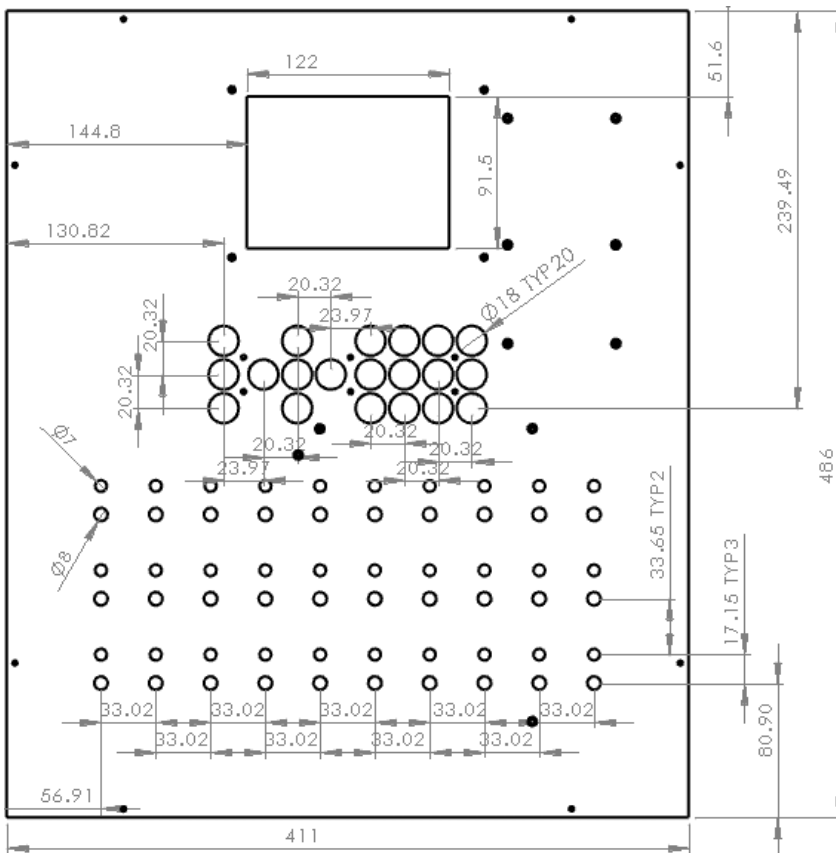

Figure 60: Platinum Pro 30 Front Panel Dimensions

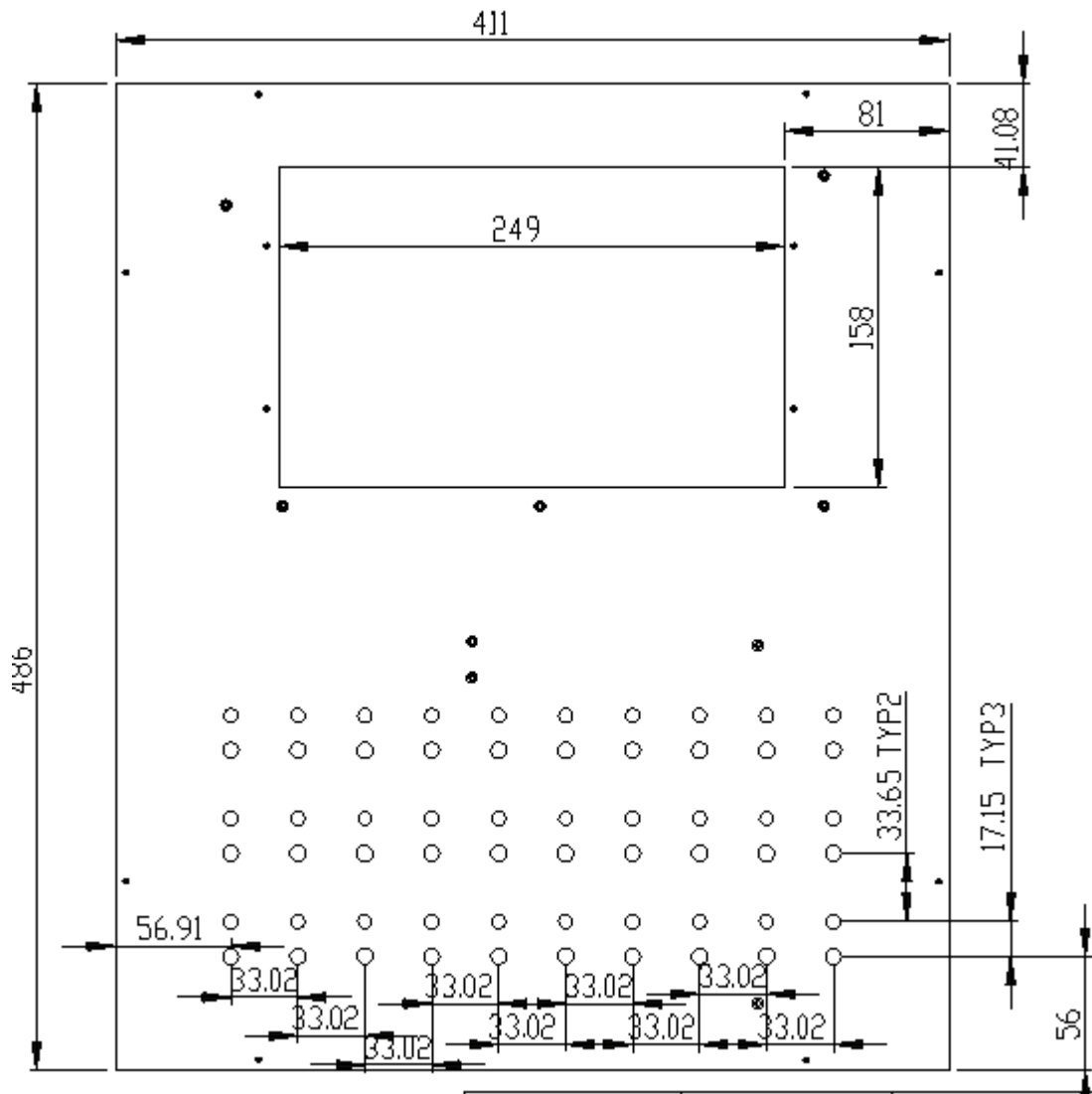

Figure 61: Platinum Touch 30 Front Panel Dimensions

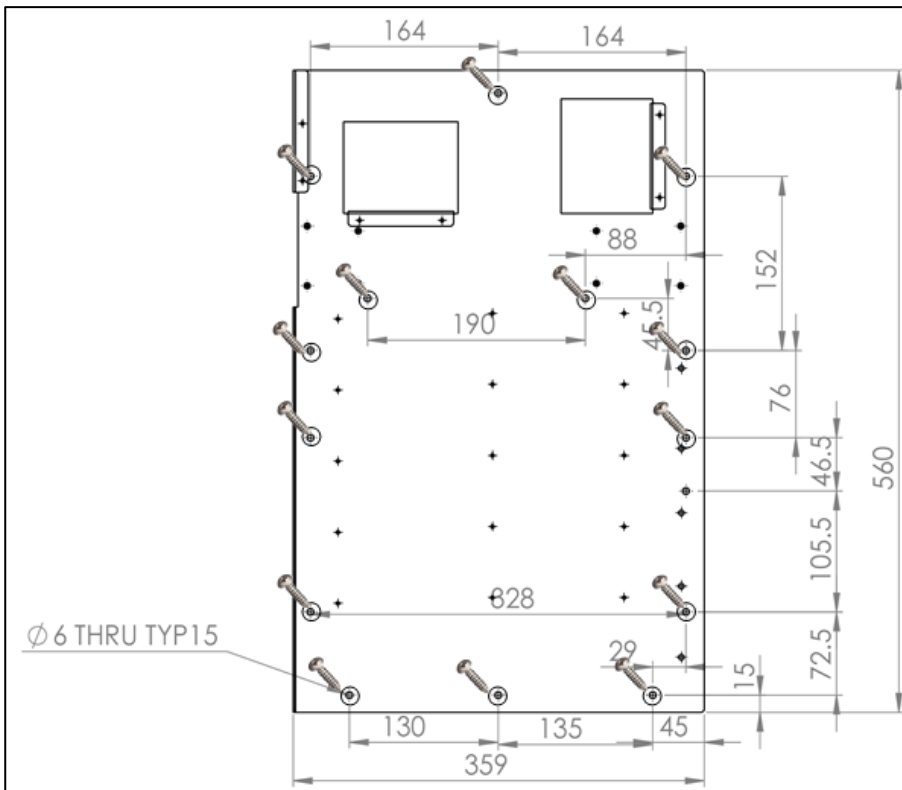

Figure 62: Platinum Pro 50 and Platinum Touch 50 Back Panel Dimensions

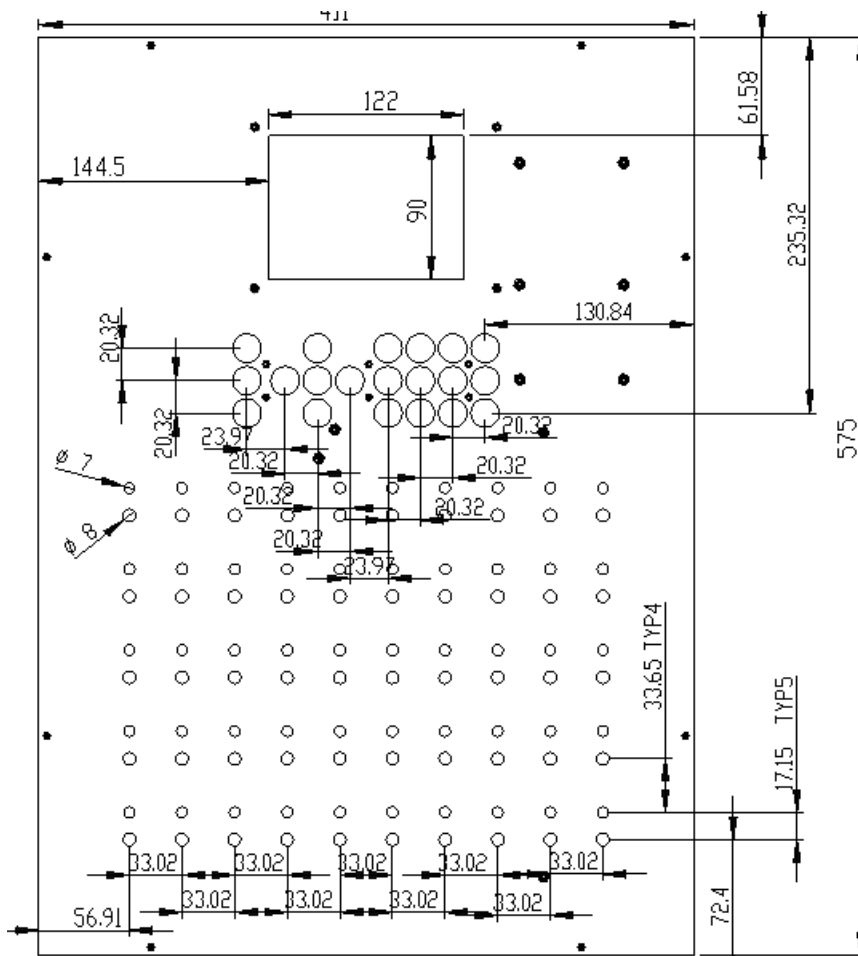

Figure 63: Platinum Pro 50 Front Panel Dimensions

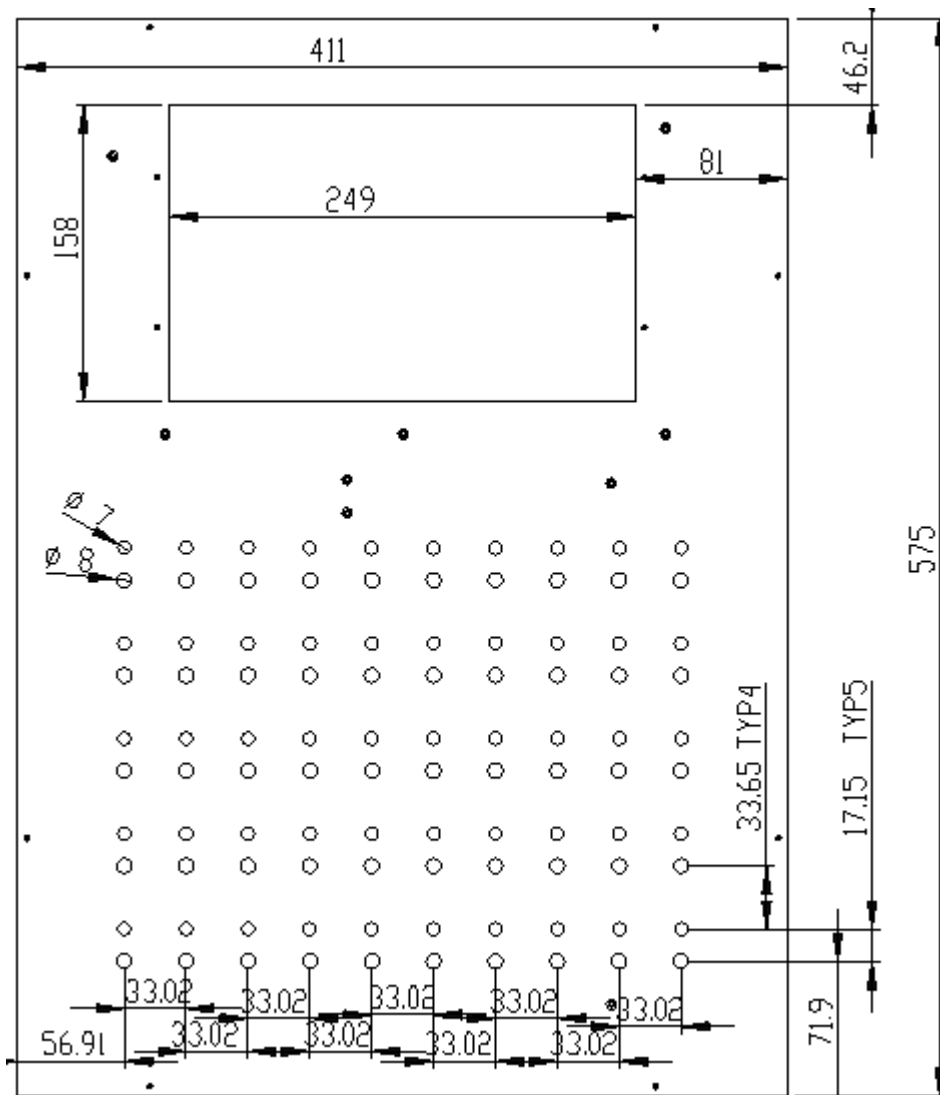

Figure 64: Platinum Touch 50 Front Panel Dimensions

9.4 Mounting the Panels

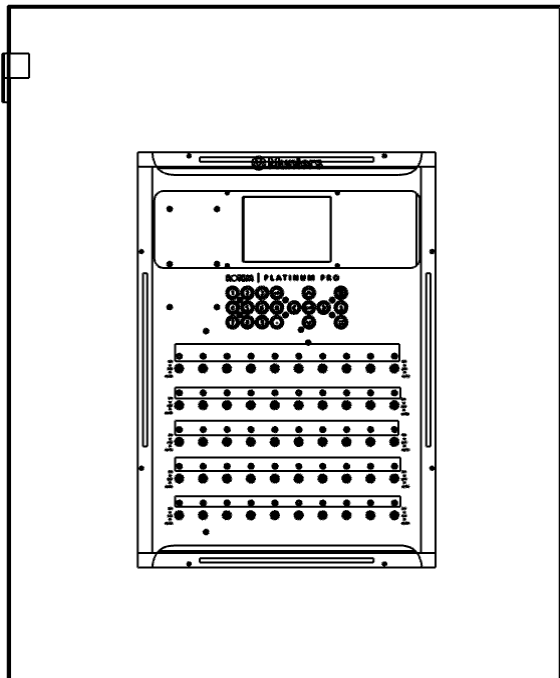

Figure 65: Panel Mount, Closed Closet

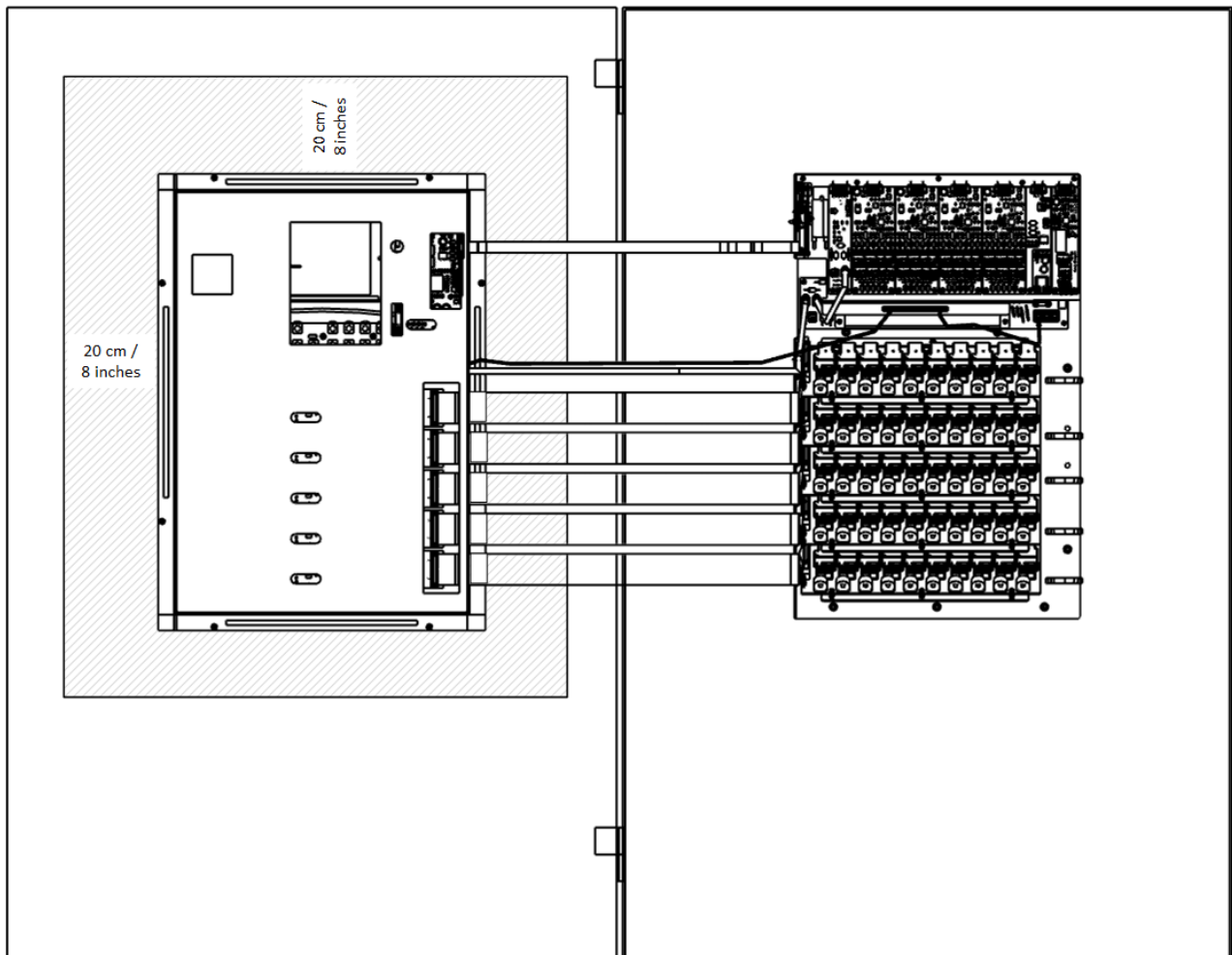

Figure 66: Panel Mount, Open Closet

- Mount the Metal Panel Front Door on the left door (hinge on left side).
- Cut a hole in the door that is 20 millimetres larger than the dimensions shown in Figure 59 and Figure 62.
 - Platinum Pro 30 and Platinum Touch 30 Dimensions: 480 x 380 mm
 - Platinum Pro 50 and Platinum Touch 50 Dimensions: 580 x 380 mm
- Make sure that there is at least 20 cm/8 inches between the relay and I/O metal base plate and any power contactors or other metal equipment.
- Any inverter must be at least five meters away from the controller.
- To prevent signal disruption, do not run sensor wiring via the DIN rails.
- Do not run power wires through the area of the relay and IO metal base plate.

9.5 Connecting the Metal Panels

This section illustrates how to connect the two Metal Panels. The Front Door Panel and Relay Panel come with cables and wiring attached to each panel:

- Front Door Panel: Grounding cable and Internal communication/power cable
- Relay Panel: Flat cables

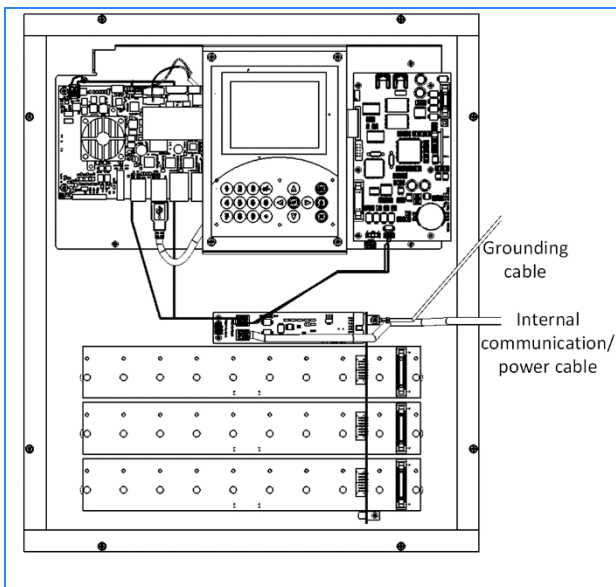

Figure 67: Front Panel and cables

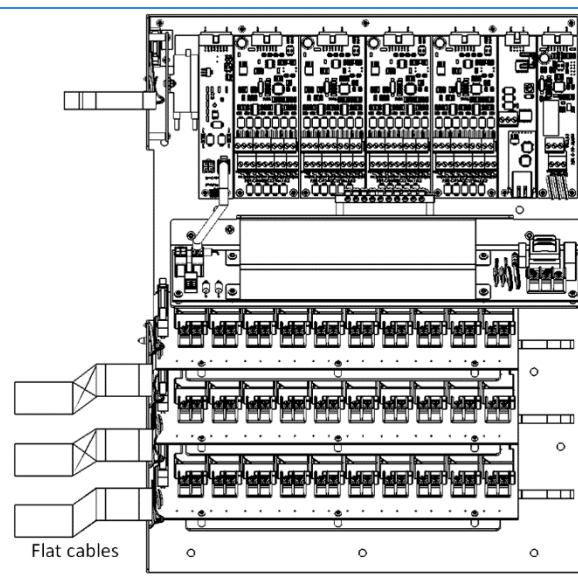

Figure 68: Relay Panel and flat cables

NOTE The procedure is illustrated using a Platinum Touch, 30 Relays. The procedure for connecting the Platinum Pro 30, Platinum Pro 50, and Platinum Touch 50 is exactly the same. However the number of flat cables can differ:

- Platinum Pro 30 Relays: up to four flat cables
- Platinum Pro/Touch 50 relays: up to six flat cables

9.5.1 PRECAUTIONS

- Ensure that the electricity is disconnected before beginning!
- When threading the cables, verify that no high-power cables are close to the low power cards (analog input/output and digital input)

- Verify that all connections are properly grounded and shielded as detailed in the manual.

9.5.2 PANEL MOUNT CABLE CONNECTIONS

1. Remove the cover from the Front Door Panel.

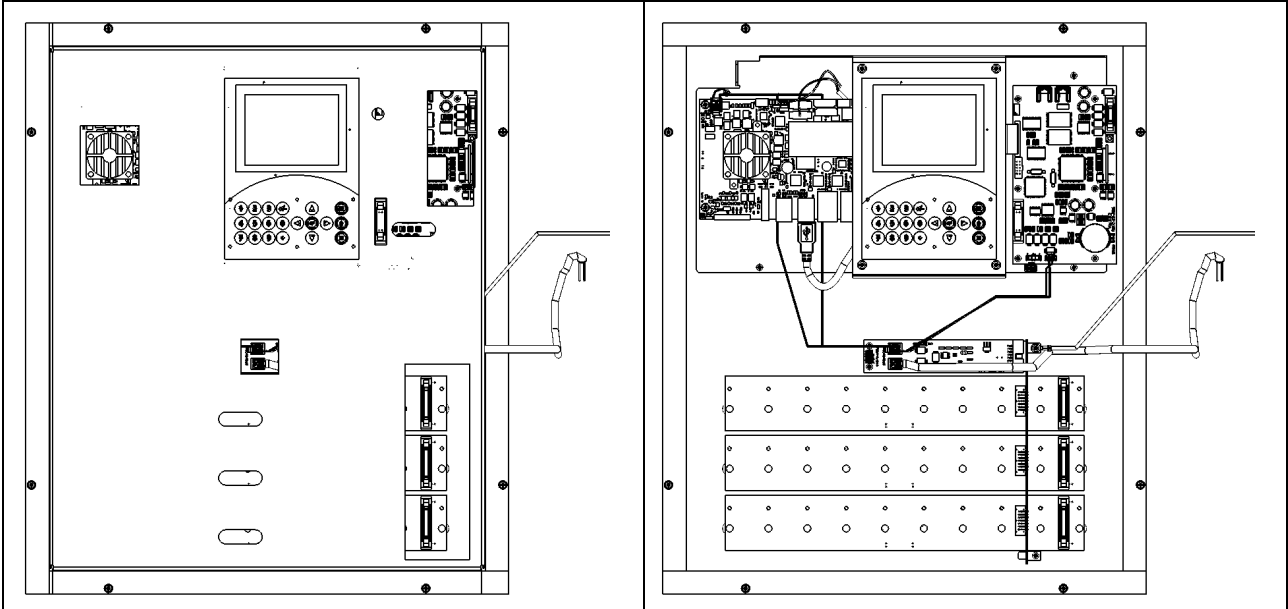

Figure 69: Cover removed

2. Connect the flat cables to the Front Door.

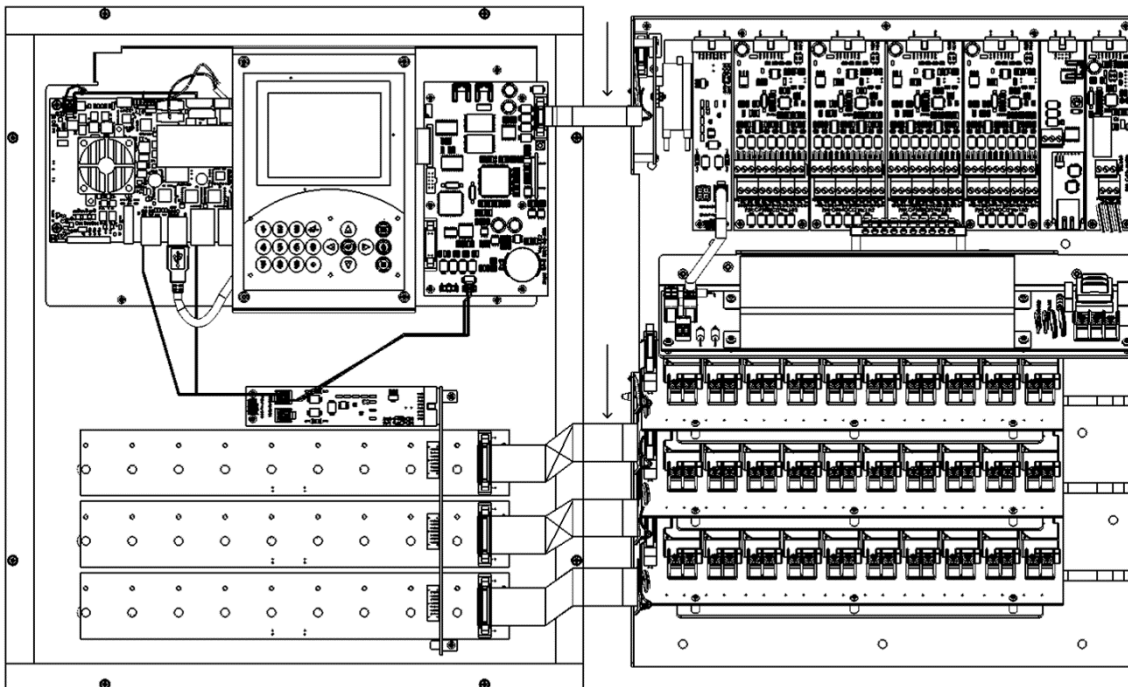

Figure 70: Flat cables connected

3. Connect the grounding cable to the Relay Panel.

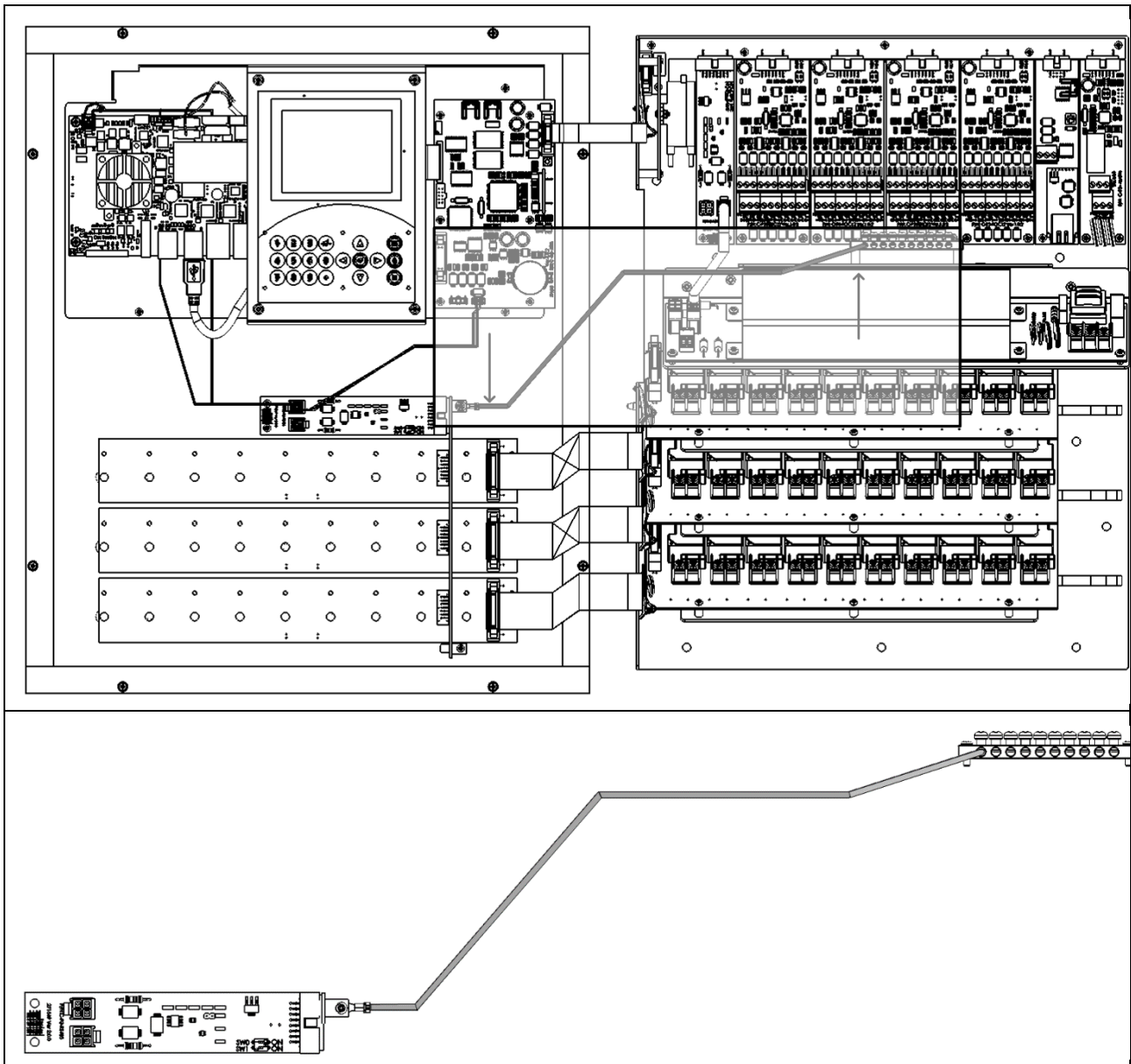

Figure 71: Grounding cable

4. Connect the internal power/communication cable to the Relay Panel.

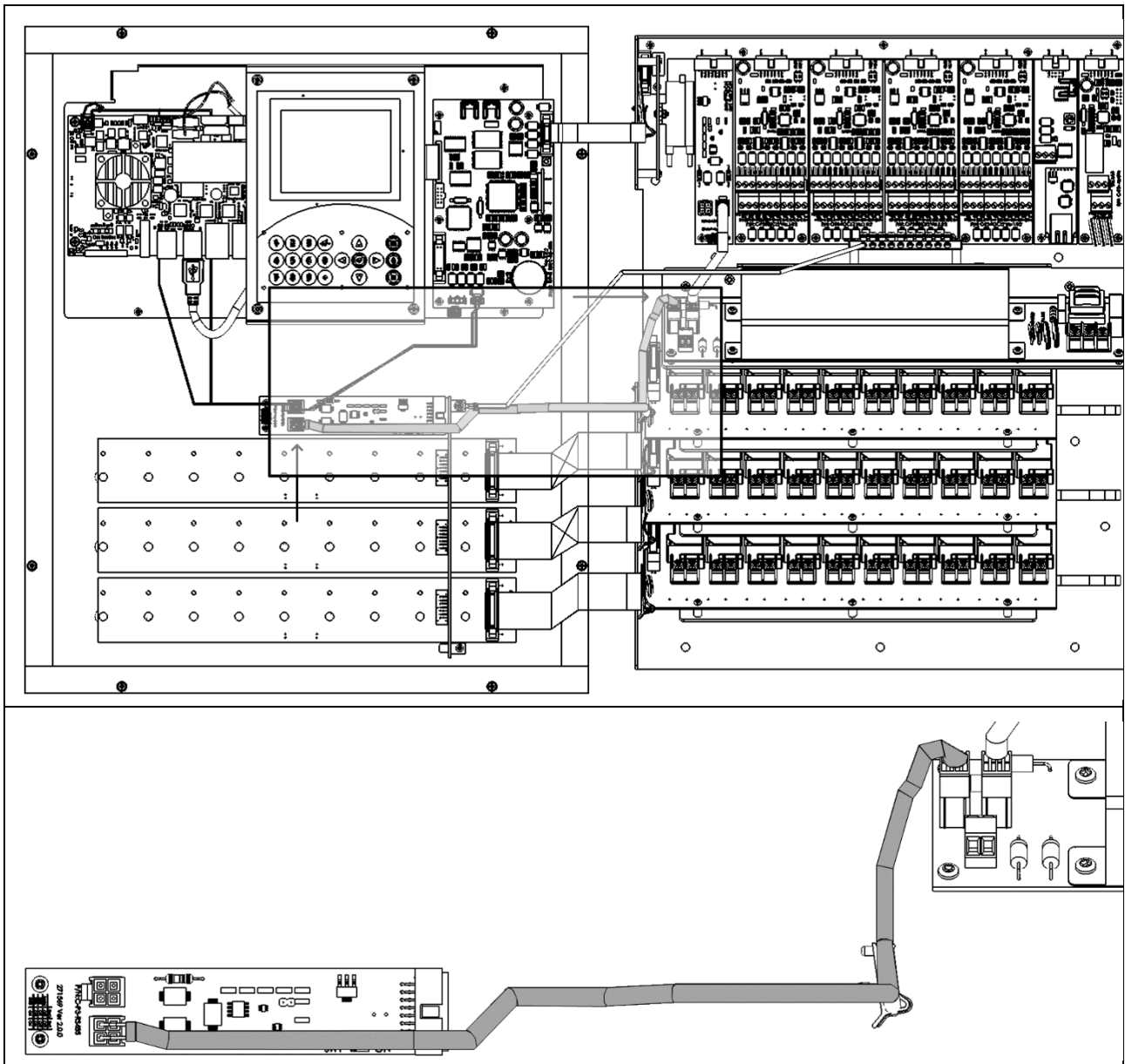

Figure 72: Internal power/communication cable

5. Connect the main power cable to the Relay Panel.

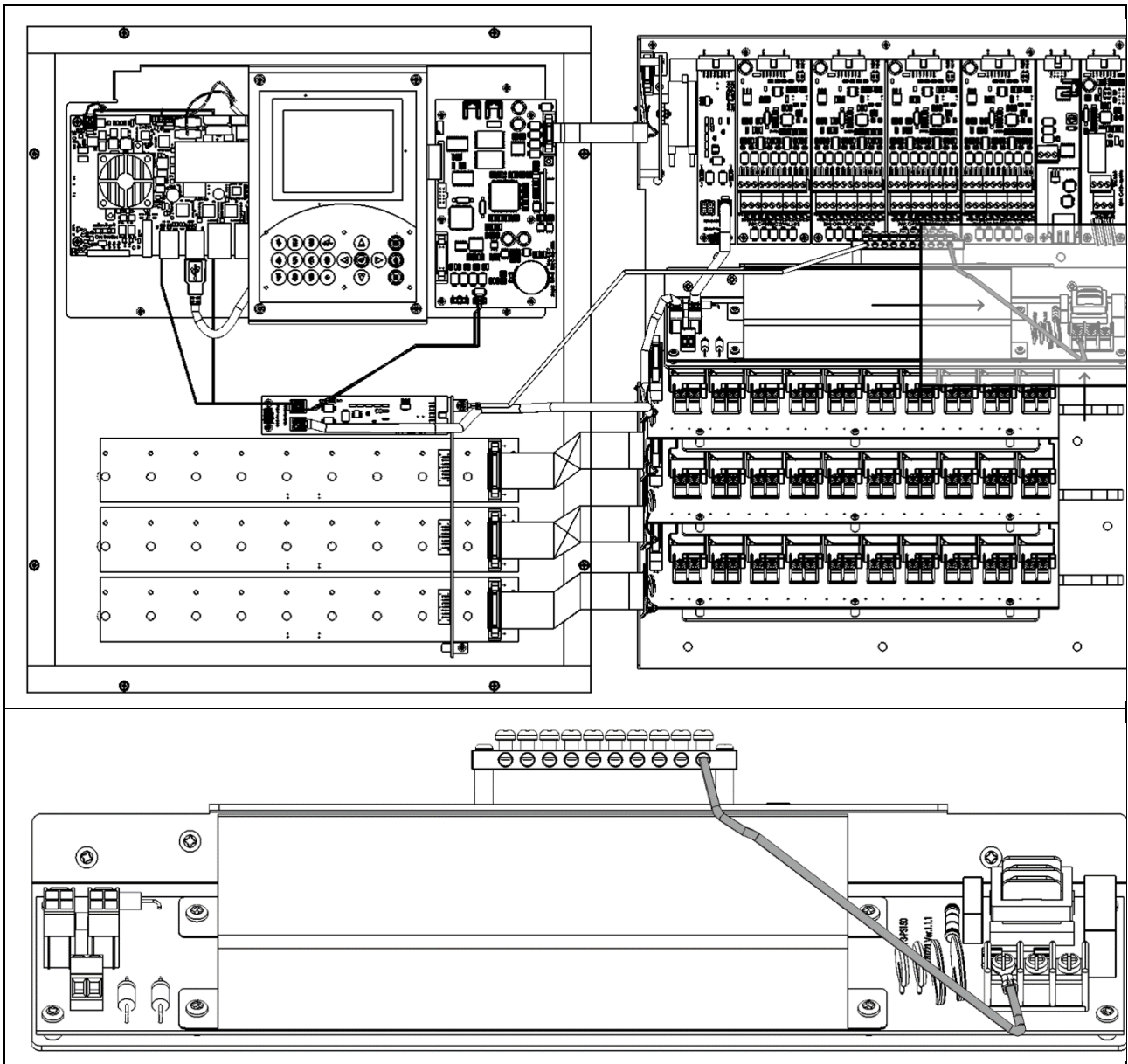

Figure 73: Main power cable

6. Replace the cover.

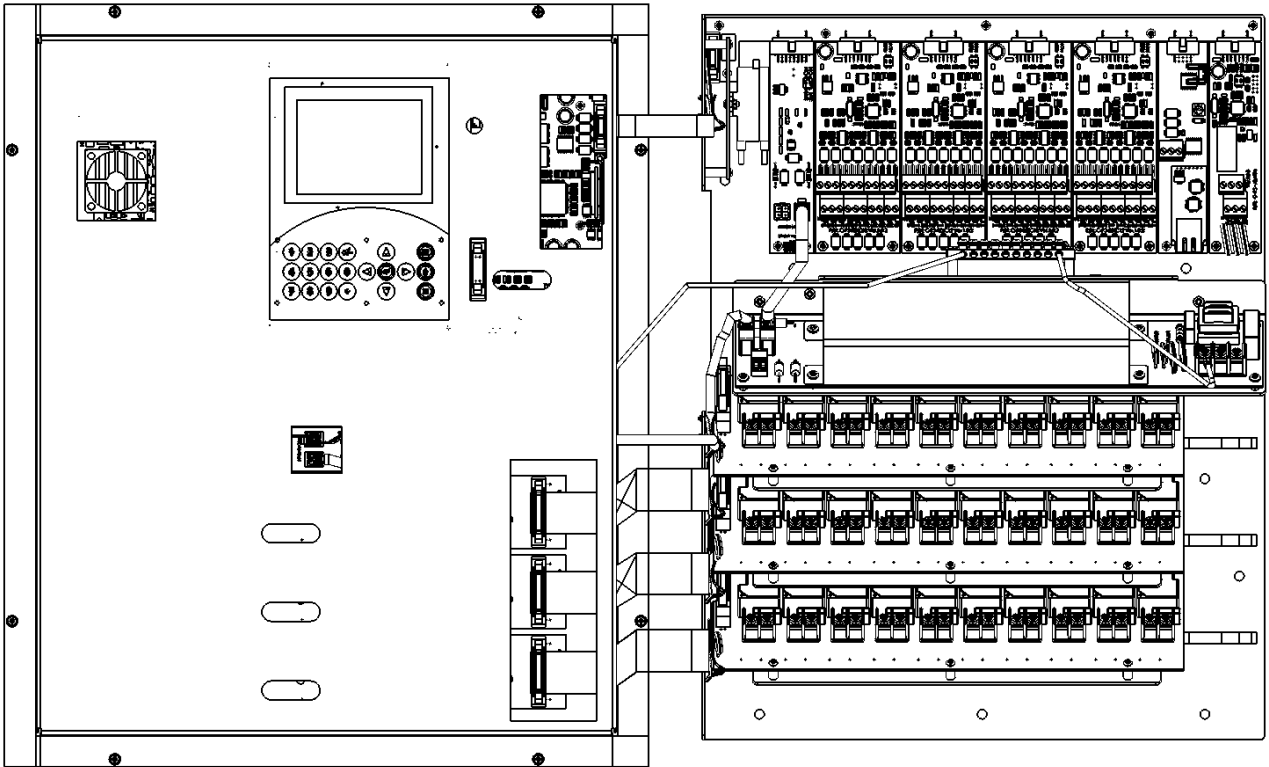
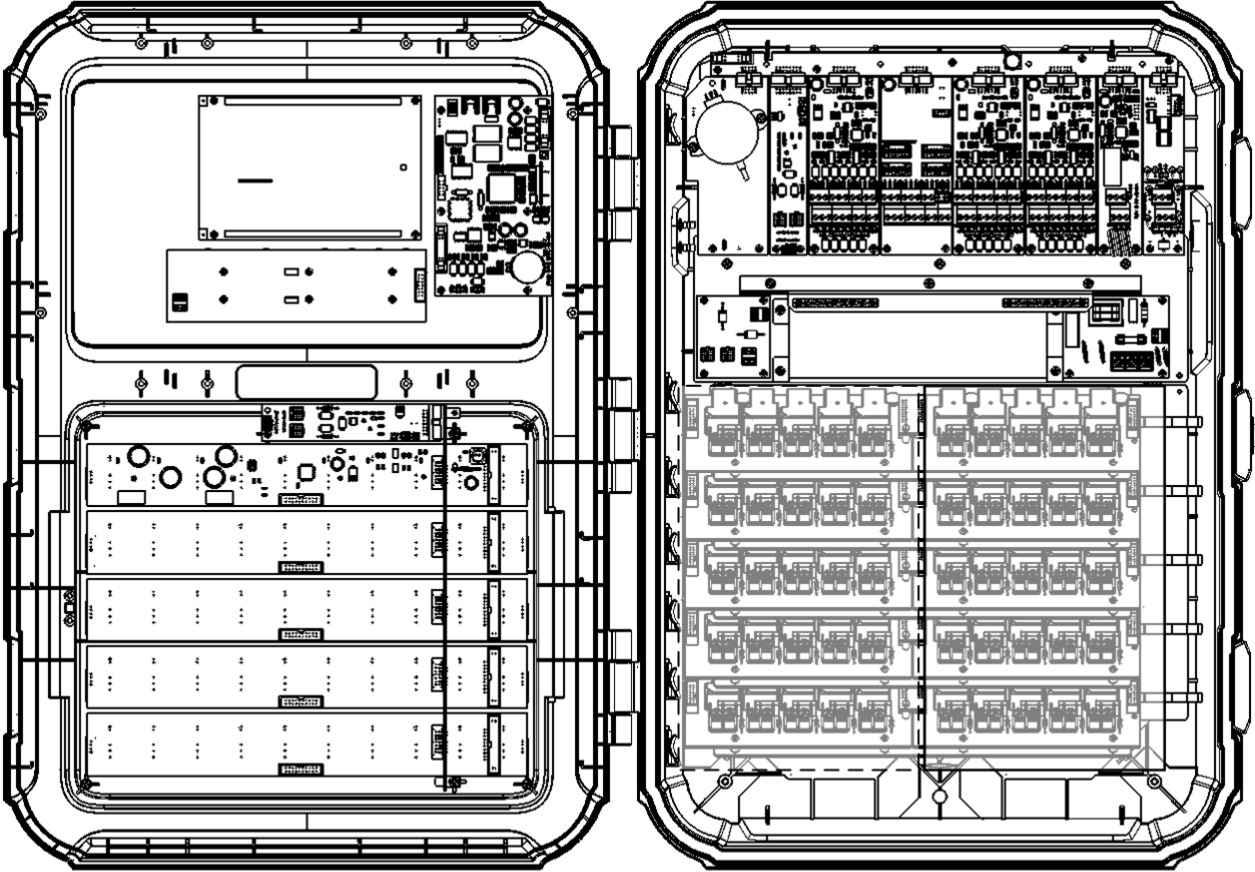

Figure 74: Panel in place

10 Appendix B: Rotem One Winch Card Set Replacement



Switch Cards

Normally Open
Relay Cards

Winch Relay
Cards

Figure 75: Rotem One Cards and Switches

10.1 General

A Rotem One Winch Card set (10 relays) consists of the following:

- One Switch Card
- One Winch Relay Card (five relays)

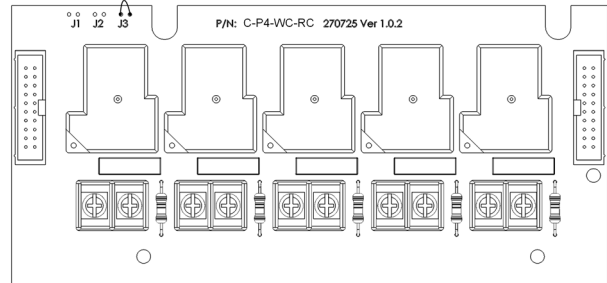

- One Normally Open Relay Card (five relays)

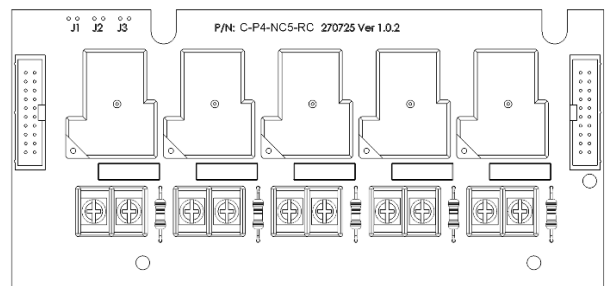

- The Winch Relay Card is always installed on the right side.
- The Normally Open Relay card is always installed on the left side.

If there is no jumper installed on the card, the card functions as a Normally Open card.

For the Winch Card to be set to function as a Winch Card, a jumper must be installed properly on the Winch Card.

10.2 In Practice

- When a customer orders a Rotem One unit that includes a winch card, all cards come installed as required, including the requisite jumper. In addition, the card comes in place if a dealer technician assembles a Rotem One unit according to the customer's specifications.
- In cases where a someone orders a (replacement) Winch Card set, before installing the card the customer/dealer must properly place the jumper on P4-WC-RC card for the winch card to operate properly
 - Solder a jumper to J3.
 - Refer to the following drawing.

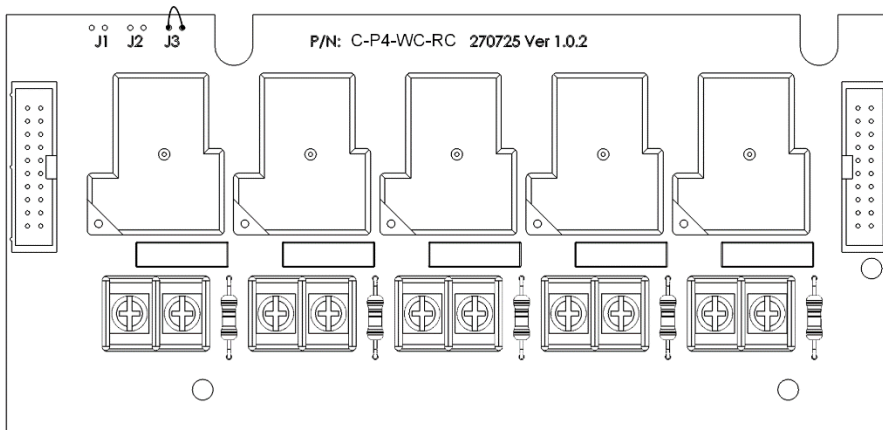

Figure 76: Placing the Jumpers

10.3 Relay Card Layout Considerations

- When installing or replacing Normally Closed cards, all ten relays in any given row must be Normally Closed cards.
- When installing or replacing Normally Open cards, all ten relays in any given row must be set to Normally Open UNLESS the Normally Open Winch Relay Cards are used.

11 Appendix C: Appendix D: Electromagnetic Noise Suppression Circuit/Circuit de Suppression de Bruit Electromagnetique

- English
- Française

11.1 English

NOTE The following section is relevant to Rotem One and Rotem Pro units only.

A snubber circuit suppresses electromagnetic interference during relay switching. Each relay on the Relay Cards has a jumper that defines that relay's noise suppression circuit.

In installations when replacing any Relay Card Version 1.02 with Version 1.1.0:

- In installations employing single-phase electricity, to directly driven devices, install the card as is (leave the jumpers in place).
- In installations employing three-phase electricity, through power contactors or relays, remove the jumper from the corresponding relay.

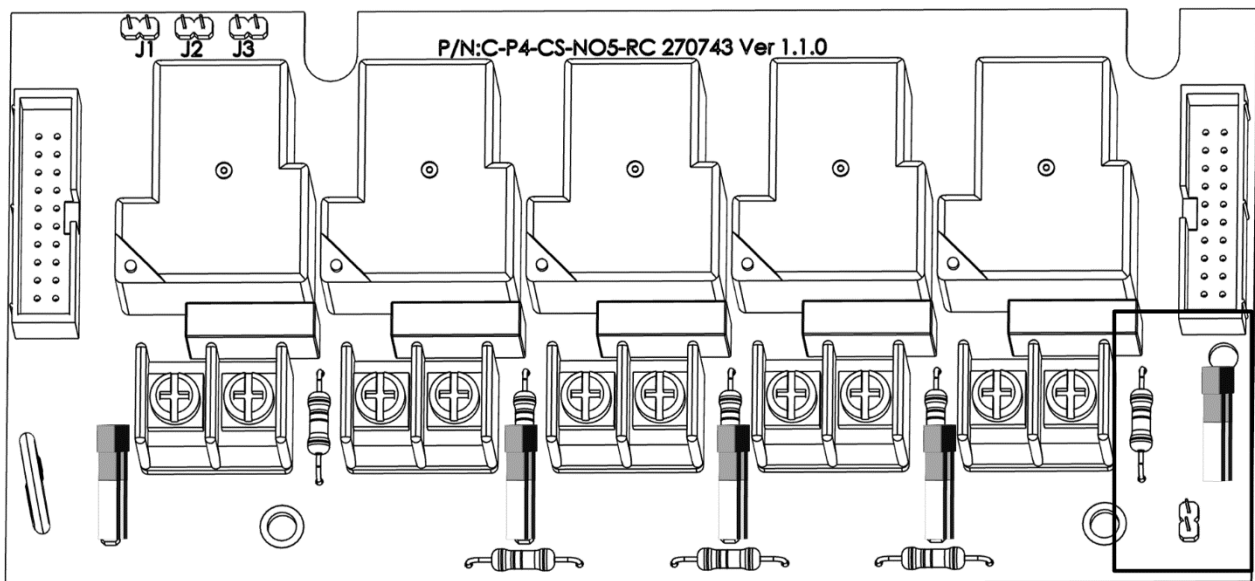

Figure 77: Removing the Jumper

11.2 Française

NOTE La section suivante concerne uniquement les unités Rotem One et Rotem Pro.

Le circuit d'amortissement élimine les interférences électromagnétiques lors de la commutation du relais. Chaque relais sur les cartes de relais possède un cavalier électrique qui définit le circuit de suppression de bruit de ce même relais.

Dans lors d'un remplacement d'une carte relais Version 1.02 avec la Version 1.1.0:

- Dans les installations qui utilise une électricité monophasée, sur des appareils directement pilotés, installez la carte telle quelle (laissez les cavaliers électriques à leur place).
- Dans les installations qui utilise une électricité triphasée, par des contacteurs ou des relais de puissance, retirez le cavalier électrique du relais correspondant.

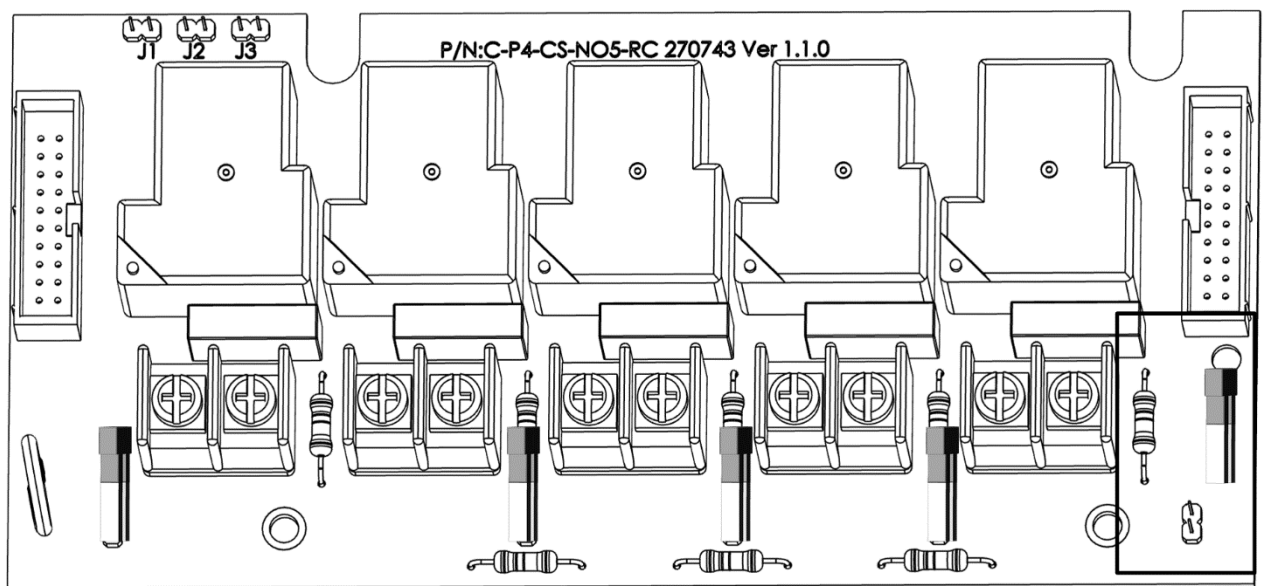

Figure 78: Retrait du cavalier électrique

12 Warranty

Warranty and technical assistance

Munters products are designed and built to provide reliable and satisfactory performance but cannot be guaranteed free of faults; although they are reliable products they can develop unforeseeable defects and the user must take this into account and arrange adequate emergency or alarm systems if failure to operate could cause damage to the articles for which the Munters plant was required: if this is not done, the user is fully responsible for the damage which they could suffer.

Munters extends this limited warranty to the first purchaser and guarantees its products to be free from defects originating in manufacture or materials for one year from the date of delivery, provided that suitable transport, storage, installation and maintenance terms are complied with. The warranty does not apply if the products have been repaired without express authorisation from Munters, or repaired in such a way that, in Munters' judgement, their performance and reliability have been impaired, or incorrectly installed, or subjected to improper use. The user accepts total responsibility for incorrect use of the products.

The warranty on products from outside suppliers fitted to Rotem One/Platinum Pro, (for example sensors, inputs, cables, etc.) is limited to the conditions stated by the supplier: all claims must be made in writing within eight days of the discovery of the defect and within 12 months of the delivery of the defective product. Munters has thirty days from the date of receipt in which to take action, and has the right to examine the product at the customer's premises or at its own plant (carriage cost to be borne by the customer).

Munters at its sole discretion has the option of replacing or repairing, free of charge, products which it considers defective, and will arrange for their despatch back to the customer carriage paid. In the case of faulty parts of small commercial value which are widely available (such as bolts, etc.) for urgent despatch, where the cost of carriage would exceed the value of the parts, Munters may authorise the customer exclusively to purchase the replacement parts locally; Munters will reimburse the value of the product at its cost price.

Munters will not be liable for costs incurred in demounting the defective part, or the time required to travel to site and the associated travel costs. No agent, employee or dealer is authorised to give any further guarantees or to accept any other liability on Munters' behalf in connection with other Munters products, except in writing with the signature of one of the Company's Managers.

WARNING! *In the interests of improving the quality of its products and services, Munters reserves the right at any time and without prior notice to alter the specifications in this manual.*

The liability of the manufacturer Munters ceases in the event of:

- dismantling the safety devices;
- use of unauthorised materials;

- inadequate maintenance;
- use of non-original spare parts and accessories.

Barring specific contractual terms, the following are directly at the user's expense:

- preparing installation sites;
- providing an electricity supply (including the protective equipotential bonding (PE) conductor, in accordance with CEI EN 60204-1, paragraph 8.2), for correctly connecting the equipment to the mains electricity supply;
- providing ancillary services appropriate to the requirements of the plant on the basis of the information supplied with regard to installation;
- tools and consumables required for fitting and installation;
- lubricants necessary for commissioning and maintenance.

It is mandatory to purchase and use only original spare parts or those recommended by the manufacturer.

Dismantling and assembly must be performed by qualified technicians and according to the manufacturer's instructions.

The use of non-original spare parts or incorrect assembly exonerates the manufacturer from all liability.

Requests for technical assistance and spare parts can be made directly to the nearest [Munters office](#).

