

Installation Manual

Trio 20 Poultry Controller

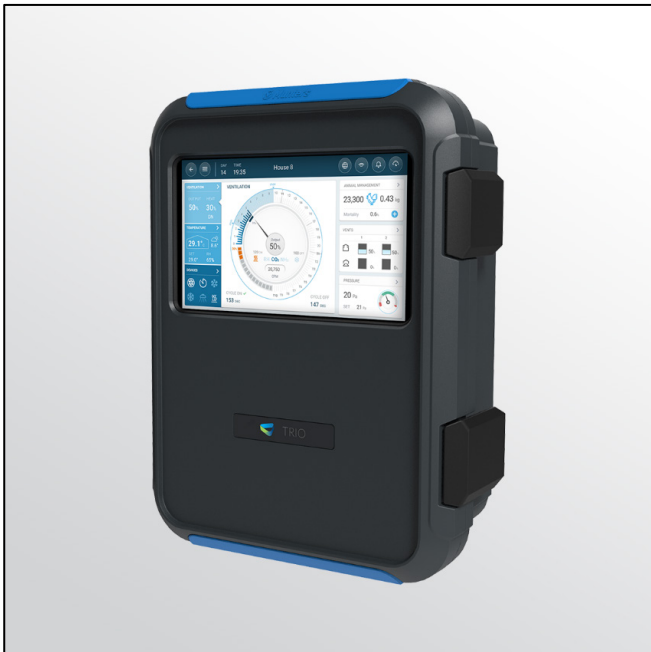

Trio 20

Poultry Controller

Ag/MIS/ImIT-2850-11/22 Rev 3.0
P/N: 117858



Trio Poultry Controller

Installation Manual

Rev 3.0, 09/2024

Product Software: Version 8.3.13

This manual for use and maintenance is an integral part of the apparatus together with the attached technical documentation.

This document is destined for the user of the apparatus: it may not be reproduced in whole or in part, committed to computer memory as a file or delivered to third parties without the prior authorization of the assembler of the system.

Munters reserves the right to effect modifications to the apparatus in accordance with technical and legal developments.

Index

<i>Chapter</i>		<i>page</i>
1	INTRODUCTION.....	9
1.1	Disclaimer.....	9
1.2	Introduction.....	9
1.3	Notes.....	9
2	PRECAUTIONS	10
2.1	English	10
2.1.1	Protection Against Corrosion.....	10
2.1.2	Electrical Guidelines.....	11
2.1.3	Grounding Sensors.....	11
2.1.4	Reducing Interference.....	11
2.1.5	Filtering.....	11
2.1.6	Checking the Battery Level.....	12
2.1.7	Safety Precautions - Details	12
2.1.8	Grounding the Controller.....	12
2.1.8.1	Ground Rods.....	12
2.1.8.2	Ground Wire	13
2.1.8.3	Ground Clamps.....	13
2.1.8.4	What Should Be Grounded?	13
2.1.8.5	Lightening Protection.....	14
2.1.8.6	Power Line Protection	14
2.2	Française.....	14
2.2.1	Protection Contre la Corrosion.....	14
2.2.2	Directives Électriques.....	15
2.2.3	Raccord à la Terre (Sensores).....	15
2.2.4	Réduire les Interférences	15
2.2.5	Filtrage	16
2.2.6	Vérification du Niveau de la Batterie.....	16
2.2.7	Précautions de Sécurité - Détails	16
2.2.8	Mise à la Terre Pour les Contrôleurs.....	16
2.2.8.1	Piquets de Prise de Terre	17
2.2.8.2	Fil de Garde.....	17
2.2.8.3	Colliers de Mise à la Terre	18
2.2.8.4	Quels Elements Doivent etre mis a la Terre?.....	18
2.2.8.5	Protection Parafoudre.....	18

2.2.8.6	Protection de Ligne Électrique	18
2.3	Locking the Trio.....	19
2.4	Product Symbols.....	19
3	UNIT INSTALLATION	20
3.1	What Comes in the Package	20
3.2	Mounting the Unit	20
3.2.1	Knockouts.....	20
3.2.2	Hanging the Unit.....	21
3.3	Board Layout	22
3.4	Wiring Diagrams.....	25
3.4.1	High Voltage Relays.....	25
3.4.2	Alarms and Power.....	27
3.4.3	Internet Connection	28
3.4.4	Analog Output Devices	29
3.4.5	Digital Devices	30
3.4.6	Analog Input Devices.....	31
3.4.6.1	CO2 Sensor Wiring	31
3.4.6.2	Temperature Sensor Wiring.....	33
3.4.6.3	Humidity Sensor Wiring.....	35
3.4.6.4	Potentiometer Wiring	37
3.4.6.5	Ammonia Sensor Wiring.....	38
3.4.6.6	Light Sensor Wiring.....	40
3.4.7	Trio RPS.....	41
3.4.8	Bird Scale Card	43
3.4.9	Silo Wiring.....	45
3.4.10	RSU Wiring.....	47
3.4.11	RLED 2.0 Wiring.....	48
3.4.12	Batch Weighing.....	48
3.4.12.1	External Batch Bin Installation.....	48
3.4.12.2	Electronic Batch Weighing Installation	50
3.4.12.2.1	Wiring and Mapping	50
3.4.12.2.2	Batch Bin Calibration.....	54
3.5	Trio – RSU/RLED 2.0 Wiring Termination	56
3.6	Pressure Sensor Hoses	58
3.7	Tech Support/Wi-Fi.....	58
4	TRIOAIR	60
4.1	Access the App	60
4.2	Sign Up	60
4.3	Adding a Controller to a Farm During Installation	61
4.4	Offline Registration	63

5	SPECIFICATIONS	65
5.1	Trio Specifications	65
5.2	External Device Specifications	66
6	USING THE TRIO TOUCH SCREEN	68
7	MAPPING AND DEFINING THE INPUT OUTPUT DEVICES	70
7.1	Using the Mapping Screen.....	70
7.2	Mapping Sensors	73
7.2.1	Enabling/Disabling Analog Input Sensors.....	74
7.2.2	Temperature Sensors	74
7.2.2.1	Defining the Temperature Sensors	75
7.2.2.2	Mapping the Temperature Sensors.....	75
7.2.2.3	Enabling a Weather Station.....	76
7.2.3	Defining the Ammonia Sensor	77
7.2.4	Defining the CO2 Sensor	77
7.2.5	Defining the Humidity Sensors	78
7.2.6	Defining the Water Meter Sensors.....	79
7.2.7	Defining the Gas Meter Sensors.....	79
7.2.8	Defining the Power Meter Sensors.....	80
7.2.9	Defining the Light Sensor	80
7.2.10	Defining the Auger Active Sensors.....	81
7.2.11	Defining the Feeder Active Sensors.....	81
7.3	Mapping Devices.....	81
7.3.1	Defining the Fans.....	82
7.3.1.1	On-Off Fans.....	82
7.3.1.2	0 – 10 Volt Fans.....	83
7.3.2	Defining the Stir Fan.....	83
7.3.2.1	On Off Stir Fan	83
7.3.2.2	0 – 10 Volt Stir Fan.....	84
7.3.3	Heating Devices	84
7.3.3.1	Defining the On/Off Heaters.....	84
7.3.3.2	Defining the Variable Heaters.....	85
7.3.3.3	Defining the High Heaters	85
7.3.4	Defining the Cooling Devices.....	86
7.3.5	Potentiometers, Inlets, Tunnel Doors, Outlets.....	87
7.3.5.1	Mapping the Potentiometers	87
7.3.5.2	Defining the Inlets/Tunnel Doors	88
7.3.5.2.1	Potentiometer Calibration	88
7.3.5.2.2	Calibrating the Inlets/Tunnel Door.....	89
7.3.5.3	Defining the Outlet.....	91
7.3.6	Defining the Same As Relays.....	91

7.3.7	Defining the Same As Analog Ports.....	92
7.3.8	Defining the Timers.....	93
7.3.9	Defining the Auxiliary Input.....	93
7.3.10	Lighting Devices.....	94
7.3.10.1	Defining the On/Off LIGHTS.....	94
7.3.10.2	Defining the Variable LIGHTS.....	94
7.3.10.3	Defining the RLED 2.0.....	95
7.3.11	Feeding Devices.....	96
7.3.11.1	Defining the Auger Relays.....	96
7.3.11.2	Defining the Feeder Relays.....	97
7.3.12	Fail Safe Devices.....	97
7.4	Mapping the Weighing Devices.....	98
7.4.1	Defining the Silos.....	98
7.4.1.1	Mapping the Silo Scales.....	98
7.4.1.2	Configuring the Silo Scale.....	100
7.4.1.3	Testing the Silo.....	104
7.4.2	Defining BinTrac Silos.....	105
7.4.3	Defining the Bird Scales.....	106
7.4.3.1	Mapping the Bird Scales.....	106
7.4.3.2	Calibrating the Bird Scales.....	107
7.4.3.3	Testing the Bird Scale.....	109
7.4.4	Defining the RSU.....	110
7.5	Trio RPS.....	111
7.5.1	Defining the Sensor.....	111
7.5.2	Static Pressure Calibration.....	111
7.6	Testing Devices.....	113
8	APPENDIX A: EXTERNAL DEVICES (PREVIOUS VERSIONS).....	115
9	APPENDIX B: SERVICE MANUAL.....	119
9.1	Maintenance.....	119
9.2	Trouble Shooting.....	120
9.2.1	Internet.....	120
9.2.2	Electronic Components.....	121
9.3	Spare Parts.....	122
9.3.1	Preliminary Information.....	122
9.3.2	Trio Minimal Spare Parts.....	123
9.3.2.1	Global Customers.....	123
9.3.2.2	Chinese Customers.....	123
9.3.3	Trio 20 Container Spare Parts.....	124
9.3.4	Trio 20 Door Card Spare Parts.....	126
9.3.5	Trio 20 Main Container Spare Parts.....	128

9.3.6	Additional Options	131
9.3.7	Cards.....	132
9.3.7.1	Door Cards.....	132
9.3.7.2	Main Container Cards.....	135
10	APPENDIX C: TRIO EXPANSION	137
10.1	Introduction.....	137
10.2	Expansion 10	137
10.2.1	Expansion Layout.....	138
10.2.2	TRIO to TRIO 10 Expansion Wiring.....	138
10.2.2.1	Wiring.....	139
10.2.2.2	Address.....	140
10.2.2.3	Restart	140
10.2.3	High Voltage Relays.....	141
10.2.4	Power	142
10.3	Expansion 20	142
10.3.1	Expansion Layout.....	143
10.3.2	Expansion Wiring Diagrams.....	143
10.3.2.1	Wiring.....	144
10.3.2.2	Address.....	145
10.3.2.3	Restart	145
10.3.3	High Voltage Relays.....	146
10.3.4	Power	147
10.4	Mapping Devices in Expansion	148
10.5	Expansion Specifications	149
10.5.1	Expansion 10 Specifications	149
10.5.2	Expansion 20 Specifications	149
10.5.3	Expansion Specification Details	150
10.6	Expansion Spare Parts.....	150
10.6.1	Preliminary Information.....	150
10.6.2	Trio Expansion 10 Spare Parts	151
10.6.2.1	Trio Expansion 10 Container Spare Parts.....	151
10.6.2.2	Trio Expansion 10 Main Container Spare Parts.....	153
10.6.3	Trio Expansion 20 Spare Parts	153
10.6.3.1	Trio Expansion 20 Container Spare Parts.....	154
10.6.3.2	Trio Expansion 20 Main Container Spare Parts.....	156
10.6.4	Additional Options	157
10.6.5	Cards.....	157
11	APPENDIX D: TRIO CELL MODEM INSTALLATION	158
11.1	Prerequisites	158
11.1.1	Supported Devices.....	158

11.1.2	Required Software.....	158
11.1.3	Internet Access.....	158
11.2	Installation.....	159
11.2.1	Physical Installation	159
11.2.1.1	Modem and SIM Card	159
11.2.1.2	Drilling.....	162
11.2.2	Configuration.....	164
12	APPENDIX E: PANEL MOUNT INSTALLATION.....	167
12.1	Trio Panel Mount Installation.....	167
12.1.1	Precautions	167
12.1.2	Panels	168
12.1.3	Panel Dimensions	169
12.1.4	Mounting the Panels.....	170
12.1.5	Panel Cables	171
12.1.6	Powering and Alarms.....	172
12.1.7	Grounding.....	172
12.2	Trio Expansion Panel Mount Installation.....	173
12.2.1	Precautions.....	173
12.2.2	Panels.....	174
12.2.3	Panel Dimensions.....	176
12.2.4	Panel Expansion Wiring.....	177
12.2.4.1	Wiring.....	177
12.2.4.2	Address.....	178
12.2.4.3	Restart	178
12.2.5	Power.....	179
13	APPENDIX F: ETHERNET REQUIREMENTS	180
13.1	Wire/Optical Ethernet Infrastructure Basics.....	180
13.2	Trio Connectivity: 100/1000Gbps Ethernet Switch	180
14	WARRANTY	181

1 Introduction

1.1 Disclaimer

Munters reserves the right to make alterations to specifications, quantities, dimensions etc. for production or other reasons, subsequent to publication. The information contained herein has been prepared by qualified experts within Munters. While we believe the information is accurate and complete, we make no warranty or representation for any particular purposes. The information is offered in good faith and with the understanding that any use of the units or accessories in breach of the directions and warnings in this document is at the sole discretion and risk of the user.

1.2 Introduction

Congratulations on your excellent choice of purchasing a Trio Poultry Controller!

In order to realize the full benefit from this product it is important that it is installed, commissioned and operated correctly. Before installation or using the controller, this manual should be studied carefully. It is also recommended that it is kept safely for future reference. The manual is intended as a reference for installation, commissioning and day-to-day operation of the Munters Controllers.

1.3 Notes

Date of release: Jan 2020

Munters cannot guarantee to inform users about the changes or to distribute new manuals to them.

All rights reserved. No part of this manual may be reproduced in any manner whatsoever without the expressed written permission of Munters. The contents of this manual are subject to change without notice.

2 Precautions

CAUTION Protection provided by the equipment can be impaired if the equipment is used in a manner not specified by the manufacturer!

CAUTION There is a risk of explosion if the lithium battery is replaced with an incorrect type. Replace the battery using the same type and manufacturer only.

- English
- Française

2.1 English

- Protection Against Corrosion
- Electrical Guidelines
- Grounding Sensors
- Reducing Interference
- Filtering
- Checking the Battery Level
- Safety Precautions - Details
- Grounding the Controller

2.1.1 PROTECTION AGAINST CORROSION

To prevent against corrosion of electrical components:

- Installation location: Install electronic controls in a separate ventilated control room that is protected from extreme temperatures and dirty environments. Place the controls so that the operators can conveniently use the control and read indicators and displays.
- Keep the Trio closed at all times when a litter or passel is present in the building. In situations where maintenance or repairs are required, close the controller when you finish the work.
- After running the cables through the knockouts, seal the holes with a silicon sealant. If you use silicon sealant with acetic acid cure, keep the controller open and ventilated until cured. Otherwise, the acetic acid will attack metal components, including circuitry.
- When splicing sensors to longer wires, ensure that the splice is **waterproof**. Use adhesive lined heat shrink (marine grade) to make waterproof connections.
- Use shielded wiring for low level signals. For buried wiring (building to building runs) use high grade jell filled cables that are impervious to moisture.

2.1.2 ELECTRICAL GUIDELINES

- Munters strongly recommends that only panel mount controllers should be installed directly in an electrical closet.
- Placing this unit in proximity (2 meters/6.5 feet or less) to any electrical device that transmits 10 amps or more of current can result in severe signal interference.
- Review the guidelines given in Safety Precautions - Details, page 12 for details. These are vital to ensuring both personal safety and proper controller functioning.

2.1.3 GROUNDING SENSORS

- Every low power device (digital, analog, or communication) must have a shield cable connected to the unit ground strip.

2.1.4 REDUCING INTERFERENCE

- Avoid mixing high voltage wiring with sensor and low voltage wiring.
- Keep the controller as far as possible from heavy contactor boxes and other sources of electrical interference.
- Do not connect communication wire shields, which go from one house to another at both ends. Connect them at one end only. Connection at both ends can cause ground loop currents to flow, which reduce reliability.
- The COM connection for communications is not the shield wire. The COM, RX and TX wires must connect to each other at all controllers.

2.1.5 FILTERING

If this installation includes a power inverter to drive variable speed fans, RLD, RVS-2, or any device that switches high electrical current, install an EMI filter in front of the device. Refer to the inverter documentation.

Any device that transmits high levels of electrical current can cause severe electrical and electromagnetic interference. Therefore, when employing these devices, it is critical that you carefully follow the manufacturer's installation instructions.

In particular verify:

- That the cable shielding between the device and any motor meets industry standards
- Proper grounding of the device's chassis and motor power cable
- Proper grounding of low voltage cable shield wire
- That the controller and device cables are kept in separate conduits or wire bundles

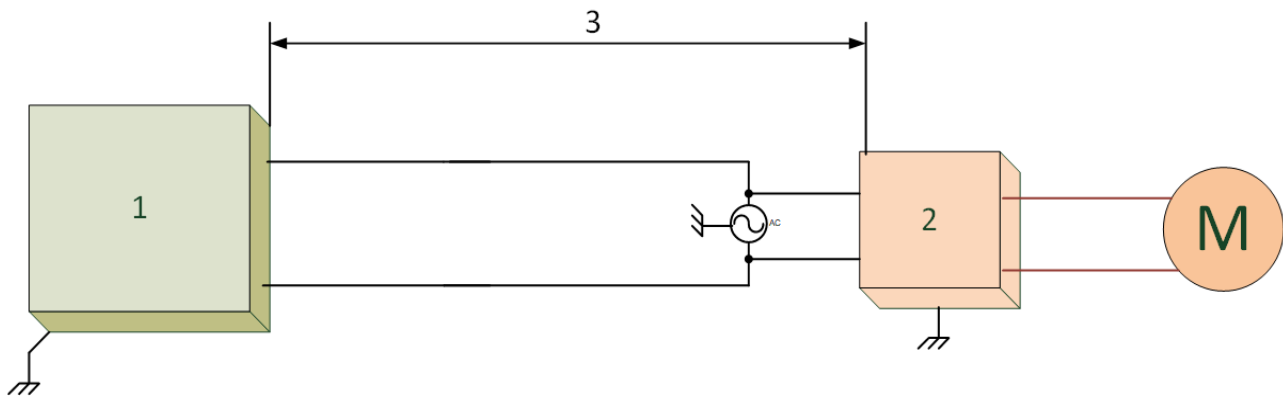

Figure 1: Device Placement

1. Controller
2. High electrical current device
3. Place the controller at least five meters from the device

2.1.6 CHECKING THE BATTERY LEVEL

Check the battery once a year. The output must be 2.7 volts (minimum). Authorized personnel only must replace the battery if the output is below the minimum required level or every five years. Use a RENATA-CR2450N battery only.

2.1.7 SAFETY PRECAUTIONS - DETAILS

CAUTION These units must be installed by an authorized electrician. Disconnect the power to avoid electrical shock and damage.

NOTE Installation Category (Over voltage Category) II

- The power supply to the controller should be protected by a 10 amp circuit breaker.
- All electrical connections should comply with National Electrical code (NEC).

2.1.8 GROUNDING THE CONTROLLER

- Ground Rods
- Ground Wire
- Ground Clamps
- What Should Be Grounded?
- Lightning Protection
- Power Line Protection

2.1.8.1 Ground Rods

Ground rods are used to efficiently connect the system to earth where current may be dissipated in the soil.

1. Material: Ground rods should be copper clad or galvanized steel.
2. Diameter: Minimum 5/8", preferably 3/4". Generally the larger the rod diameter, the lower it's resistance to current flow.

3. Length: Minimum 2.5 meters (8 feet), preferably 3-meter (10-foot). A longer ground rod will reach a soil with higher moisture content. Moist soil carries current much better than drier soil.
4. Single grounding: It is important that there is only one grounding location where a rod or series of rods are connected to each other using a ground wire.
5. Independent ground rods will increase the risk of current, from a lightning strike for example, being dissipated through one rod and reentering the system through an adjacent rod.
6. Location: Close to the main circuit breaker panel and in moist soil. For example in an area that is usually wet from a drip or a low spot where water drains. Make sure the area is well protected from damage by lawnmowers, tractors, etc.’.
7. Rod installation: Drive the rod into the earth until about 10 cm (4 inches) is left above grade. If it is impossible to drive the rod to the proper depth, it is acceptable to lay the rod horizontally, 80 cm (2.5 feet) below grade.
8. In case the rod is exposed to damage, for example by lawnmowers or tractors it can be installed in a hole, about 20 cm (8 inches) deep so that the rod is about 10 cm under grade and 10 cm above hole level.

NOTE The National Electric Code (NEC) mandates two ground rods unless you can show less than 10 ohms resistance with one rod.

2.1.8.2 Ground Wire

The ground wire is a large copper wire that connects the main circuit breaker panel to the ground rod.

1. Material: Ground rods should be copper clad or galvanized steel.
2. Diameter: Typically, 16 mm (6-gauge) copper wire is sufficient. If the wire run is greater than 20 feet, 20 mm (4-gauge) wire should be used.
3. Length: Minimum 2.5 meters (8 feet), preferably 3-meter (10-foot). A longer ground rod will reach a soil with higher moisture content. Moist soil carries current much better than drier soil.
4. The ground wire should be protected from damage by lawnmowers, tractors, etc. It should be buried minimum 15 cm (6 inches) under grade for protection and enter the house as soon as possible. It is important that the wire not be cut; it should remain continuous.

2.1.8.3 Ground Clamps

Ground wires should not be merely wrapped around a ground rod. Ground clamps are used to attach a ground wire to a ground rod. The most common clamp is known as an acorn clamp. Make sure the ground clamps you select are rated for outdoor use. Do not use pipe clamps rated for inside water lines or hose clamps to attach the ground wire.

2.1.8.4 What Should Be Grounded?

Any equipment that is or could become energized, even accidentally, should be grounded. Current from lightning, strikes objects in a random fashion. Accounts of lightning strikes reveal scenarios most of us could not predict.

Electric circuits should be wired with a 3-wire conductor consisting of hot, neutral, and grounding wires. The grounding wire should be attached cleanly and securely to devices or systems to be grounded. The other end of the grounding wire should be attached to the ground bus on the main panel.

2.1.8.5 Lightning Protection

Because of the potential for lightning damage to electronic devices, Munters recommends supplying lightning protection on both the power supply and the communication terminals (if used).

2.1.8.6 Power Line Protection

The RPLP-1 provides lightning protection to the controllers. Refer to the RPLP-1 documentation for detailed wiring instructions. While no lightning protection is perfect, the RPLP-1 significantly enhances the reliability of built-in lightning protection. In addition, Munters recommends using an isolation transformer in front of the RPLP-1 to help block lightning and other transients.

NOTE Common surge protectors provide little additional protection and may trip unnecessarily.

An isolation transformer preceding the RPLP-1 provides significant additional protection against lightning.

2.2 Française

CAUTION *La protection fournie par l'équipement peut être compromise si l'équipement est utilisé d'une façon non spécifiée par le fabricant !*

CAUTION *Il existe un risque d'explosion si la batterie au lithium est remplacée par un type incorrect. Remplacez la batterie uniquement par une batterie du même type et du même fabricant.*

- Protection Contre la Corrosion
- Directives Électriques
- Raccord à la Terre (Sensores)
- Réduire les Interférences
- Filtrage
- Vérification du Niveau de la Batterie
- Précautions de Sécurité - Détails
- Mise à la Terre Pour les Contrôleurs

2.2.1 PROTECTION CONTRE LA CORROSION

Pour éviter la corrosion des composants électriques:

- Installez les commandes électroniques dans une salle de commande ventilée séparée, à l'abri des températures extrêmes et des environnements sales. Placer les commandes de façon à ce que les opérateurs puissent facilement les utiliser et lire les indicateurs et les affichages.

- Gardez le contrôleur fermé à tout moment lorsqu'il y a de la poubelle ou un passage dans le bâtiment. Dans les situations nécessitant une maintenance ou des réparations, fermez le contrôleur lorsque vous avez terminé le travail.
- Après avoir acheminé les câbles à travers les ouvertures, scellez les trous avec un produit d'étanchéité au silicone. Si vous utilisez un mastic de silicone avec durcissement à l'acide acétique, maintenez le contrôleur ouvert et ventilé jusqu'à ce qu'il durcisse. Sinon, l'acide acétique attaquera les composants métalliques, y compris les circuits.
- Lors du raccordement de capteurs à des câbles plus longs, assurez-vous que le raccordement est étanche. Utilisez une gaine thermorétractable adhésive (qualité marine) pour réaliser des connexions étanches.
- Utilisez un câblage blindé pour les signaux de faible niveau. Pour les câbles enterrés (d'un bâtiment à l'autre), utilisez des câbles remplis de gel de haute qualité, imperméables à l'humidité.

2.2.2 DIRECTIVES ÉLECTRIQUES

- Munters recommande vivement que seuls les contrôleurs montés sur panneau soient installés directement dans une armoire électrique.
- Placer cette unité à proximité (2 mètres/6,5 pieds maximum) de tout appareil électrique transmettant 10 ampères ou plus de courant peut entraîner de graves interférences de signal.
- Consulter les consignes données dans Safety Precautions - Details, page XX pour plus de détails. Elles sont essentielles pour garantir à la fois la sécurité personnelle et le bon fonctionnement du contrôleur.

2.2.3 RACCORD À LA TERRE (SENSORES)

- Chaque appareil à faible puissance (numérique, analogique ou de communication) doit être équipé d'un câble blindé raccordé à la barrette de mise à la terre de l'unité.

2.2.4 RÉDUIRE LES INTERFÉRENCES

- Maintenez les câbles basse tension séparés des câbles haute tension. Il doit y avoir au moins un mètre entre le capteur et les câbles électriques.
- Maintenez le contrôleur aussi loin que possible du boîtier lourd de contacteur et des autres sources d'interférences électriques.
- Ne connectez les protections des fils de communication, allant d'une maison à une autre aux deux extrémités. Connectez-les à une seule extrémité uniquement. La connexion aux deux extrémités peut entraîner la circulation de courants dans la boucle de terre, et risquer ainsi de réduire la fiabilité.
- La connexion COM pour les communications n'est pas le fil blindé. Les fils COM, RX et TX doivent être connectés les uns aux autres au niveau de tous les contrôleurs.

2.2.5 FILTRAGE

Si cette installation comprend un onduleur pour entraîner des ventilateurs à vitesse variable, RLD, RVS-2 ou tout autre dispositif qui commute un courant électrique élevé, installez un filtre EMI devant l'appareil. Reportez-vous à la documentation de l'appareil.

- Que le blindage du câble entre l'appareil et tout moteur est conforme aux normes industrielles
- Mise à la terre correcte du châssis de l'appareil et du câble d'alimentation du moteur
- Mise à la terre correcte du fil blindé du câble basse tension
- Que les câbles du contrôleur et de l'appareil sont conservés dans des conduits ou faisceaux de câbles séparés

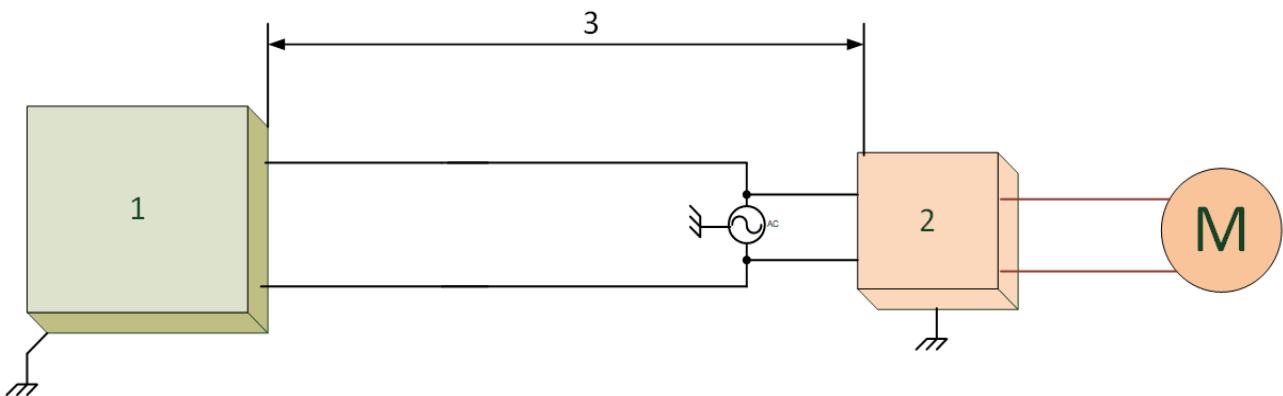

Illustration 2: Emplacement de l'onduleur

1. Contrôleur
2. Dispositif de courant électrique élevé
3. Placez le contrôleur à au moins cinq mètres de l'appareil

2.2.6 VÉRIFICATION DU NIVEAU DE LA BATTERIE

Vérifiez la batterie une fois par an. La sortie doit être 2.7 volts (minimum). Seul le personnel autorisé est en droit de remplacer la batterie si la sortie est inférieure au niveau minimum ou tous les cinq ans. Utilisez uniquement une batterie RENATA-CR2450N.

2.2.7 PRÉCAUTIONS DE SÉCURITÉ - DÉTAILS

NOTE Catégorie d'installation (catégorie de surtension) II

- L'alimentation électrique du contrôleur doit être protégée par un disjoncteur de 10 A.
- Tous les raccordements électriques doivent être conformes au National Electrical Code (NEC)

2.2.8 MISE À LA TERRE POUR LES CONTRÔLEURS

- Piquets de Prise de Terre
- Fil de Garde
- Colliers de Mise à la Terre

- Quels Elements Doivent etre mis a la Terre?
- Protection Parafoudre
- Protection de Ligne Électrique

2.2.8.1 Piquets de Prise de Terre

Les piquets de prise de terre sont utilisés pour connecter efficacement le système à la terre, lorsque le courant peut être dissipé dans le sol.

1. Matériel: Les piquets de prise de terre doivent être plaqués cuivre ou en acier galvanisé.
2. Diamètre: Minimum 12,5/20,3 cm, de préférence 7,6/10,16 cm. Généralement, plus le diamètre du piquet est gros, moindre sera sa résistance à la circulation du courant.
3. Longueur: Au minimum 2,5 mètres, de préférence 3 mètres. Un piquet de prise de terre plus long atteindra un sol avec une humidité plus élevée. Des sols humides portent beaucoup mieux le courant que des sols plus secs.
4. Mise à la terre unique: Il est essentiel qu'il n'y ait qu'un seul emplacement de mise à la terre auquel un piquet ou une série de piquets sont connectés les uns aux autres à l'aide d'un fil de garde.
5. Des piquets de prise de terre indépendants augmenteraient le risque de courant, provenant par exemple d'un éclair, dissipé par un piquet et réintégrant le système par un piquet adjacent.
6. Emplacement: Prêt du panneau de panneau du disjoncteur principal et dans un sol humide. Par exemple, dans une zone qui est habituellement humide provenant de précipitation, ou un point bas où l'eau est drainée. Assurez-vous que la zone est bien protégée des dommages pouvant être causés par des tondeuses à gazon, des tracteurs, etc.
7. Installation du piquet: Enfoncez le piquet dans le sol jusqu'à ce qu'il reste 10 cm au dessus du niveau du sol. S'il est impossible d'enfoncer le piquet à une profondeur correcte, vous pouvez poser le piquet horizontalement, 80 cm en dessous du niveau du sol.
8. Dans le cas où le piquet risque d'être endommagé, par exemple, par des tondeuses à gazon ou des tracteurs, il peut être installé dans un trou, à une profondeur d'environ 20 cm pour que le piquet soit environ 10 cm en dessous du niveau du sol et 10 cm au dessus du niveau du trou.

NOTE Le National Electric Code (NEC) a comme impératif l'utilisation de deux piquets de prise de terre, à moins que vous puissiez montrer que la résistance est inférieure à 10 ohms avec un piquet.

2.2.8.2 Fil de Garde

Le fil de garde est un fil cuivré long et épais qui connecte le panneau du disjoncteur principal au piquet de prise de terre.

1. Matériel: Les piquets de prise de terre doivent être plaqués cuivre ou en acier galvanisé.
2. Diamètre: Généralement un fil cuivré de 16 mm (de calibre no. 6) suffit. Si le fil doit parcourir plus de 7m, un fil de 20 mm (de calibre no.4) devrait être utilisé.

3. Longueur: Au minimum 2,5 mètre, de préférence 3 mètres. Un piquet de prise de terre plus long atteindra un sol avec une humidité plus élevée. Des sols humides portent beaucoup mieux le courant que des sols plus secs.

4. Le fil de garde devrait être protégé des dommages pouvant être provoqués par des tondeuses à gazon, des tracteurs, etc. Il devrait être enterré au moins à 15 cm sous le sol pour protection, et être inséré dans la maison aussi vite que possible. Il est important que le fil ne soit pas coupé, il devrait rester entier.

2.2.8.3 Colliers de Mise à la Terre

Des fils de gardes ne devraient pas simplement revêtir un piquet de prise de terre. Des colliers de mise à terre sont utilisés pour attacher un fil de garde au piquet de prise de terre. Le collier le plus ordinaire est un collier ocre. Assurez-vous que les colliers de mise à terre que vous sélectionnez sont adaptés à une utilisation à l'extérieur. N'utilisez pas de collier de serrage adapté pour des conduites d'eau intérieures ou colliers de serrage pour tuyaux flexibles pour rattacher le fil de garde.

2.2.8.4 Quels Elements Doivent etre mis a la Terre?

Tout équipement qui est ou pourrait être sous tension, même accidentellement, devrait être mis à la terre. Les objets qui pourraient être aléatoirement porteurs de la foudre y sont inclus. Des récits de foudre ont montré des cas imprévisibles.

Les circuits électriques devraient être câblés avec un conducteur à 3 fils, constitué d'un fil de garde, d'un fil conducteur neutre et d'un fil chaud. Le fil de garde devrait être rattaché nettement et sûrement aux dispositifs ou aux systèmes à mettre à la terre. L'autre extrémité du fil de garde devrait être rattachée au collecteur de terre sur le panneau principal.

2.2.8.5 Protection Parafoudre

En raison du risque de dommages causés par la foudre sur les appareils électroniques, Munters recommande d'installer une protection contre la foudre sur l'alimentation électrique et les bornes de communication (le cas échéant).

2.2.8.6 Protection de Ligne Électrique

Le RPLP-1 fournit une protection contre la foudre aux contrôleurs. Reportez-vous à la documentation RPLP-1 pour des instructions de câblage détaillées. Bien qu'aucune protection contre la foudre ne soit parfaite, le RPLP-1 améliore considérablement la fiabilité de la protection contre la foudre intégrée. De plus, Munters recommande d'utiliser un transformateur d'isolement devant le RPLP-1 pour aider à bloquer la foudre et d'autres transitoires.

Les parasurtenseurs communs offrent peu de protection supplémentaire et peuvent se déclencher inutilement.

Un transformateur d'isolement précédant le RPLP-1 offre une protection supplémentaire importante contre la foudre.

2.3 Locking the Trio

Ensure that the units remains locked to prevent unauthorized access to internal components.

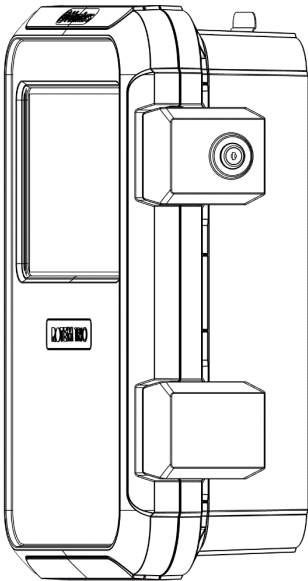

Figure 3: Trio Lock

2.4 Product Symbols

The following labels appear on your controller:



: Caution! Hazardous voltage



: Caution: Refer to the manual



: Main Protective Earthing Terminal

CAUTION IF THE UNIT IS USED IN A MANNER NOT SPECIFIED BY THE MANUFACTURER, THE PROTECTION PROVIDED BY THE EQUIPMENT MAY BE IMPAIRED.

3 Unit Installation

The following sections detail how to mount and wire the Trio.

NOTE Munters recommends that a trained technician perform the following operations.

- What Comes in the Package
- Mounting the Unit
- Board Layout
- Wiring Diagrams
- Trio – RSU/RLED 2.0 Wiring Termination
- Pressure Sensor Hoses
- Tech Support/Wi-Fi

3.1 What Comes in the Package

- One Trio unit
- One hanging bracket and screws
- Two keys
- RTS-2 sensors (number depending on order)

3.2 Mounting the Unit

- Knockouts
- Hanging the Unit

3.2.1 KNOCKOUTS

1. At the bottom the Trio are knockouts used to route the low and high voltage cables.

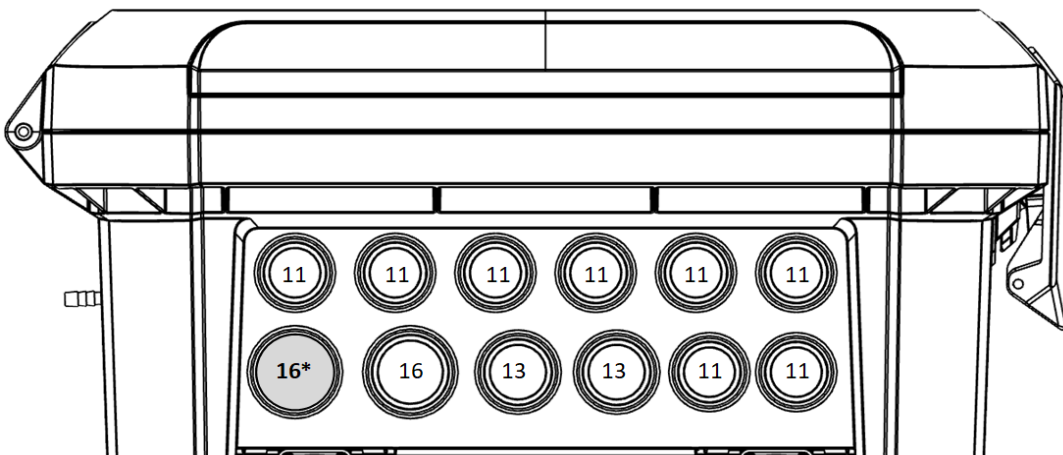

Figure 4: Trio Knockouts and PG Size

- Using a screwdriver and a hammer, gently apply pressure to the knockouts.
- **Only open up the holes that you require.**
- Munters recommends removing the knockouts before mounting the unit.
- 16*: Use this knockout for the Ethernet cable.

2. Place the required cables through the cable holders at the bottom of the unit.

CAUTION Run low voltage cables through one knockout and high voltage relay cables through a separate knockout. Do not place them in the same knockout!

3. Close the Trio enclosure lid carefully and tightly. Use RTV silicon or equivalent sealant to seal the cable holders.

CAUTION Munters strongly recommends that you seal all entry spots with RTV silicon. Failure to do so can lead to damage to the unit.

4. After installation is completed, operate the Trio for a few hours and re- check for proper operation.

3.2.2 HANGING THE UNIT

1. Attach the bracket to the wall (customer supplies the screws).

2. Hang the Trio on the bracket.

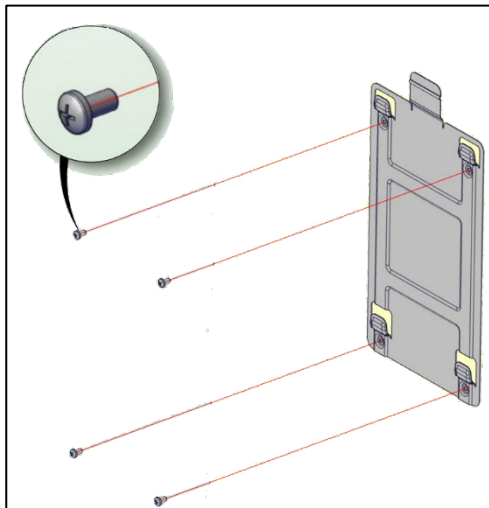

Figure 5: Hanging the Bracket

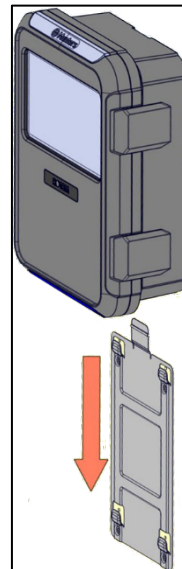

Figure 6: Hanging the Unit

3. Close the TRIO enclosure lid carefully and tightly. Use RTV silicon or equivalent sealant to seal the cable holders.

CAUTION Munters strongly recommends that you seal all entry spots with RTV silicon. Failure to do so can lead to damage to the unit.

4. After installation is completed, operate the TRIO for a few hours and re- check for proper operation.

3.3 Board Layout

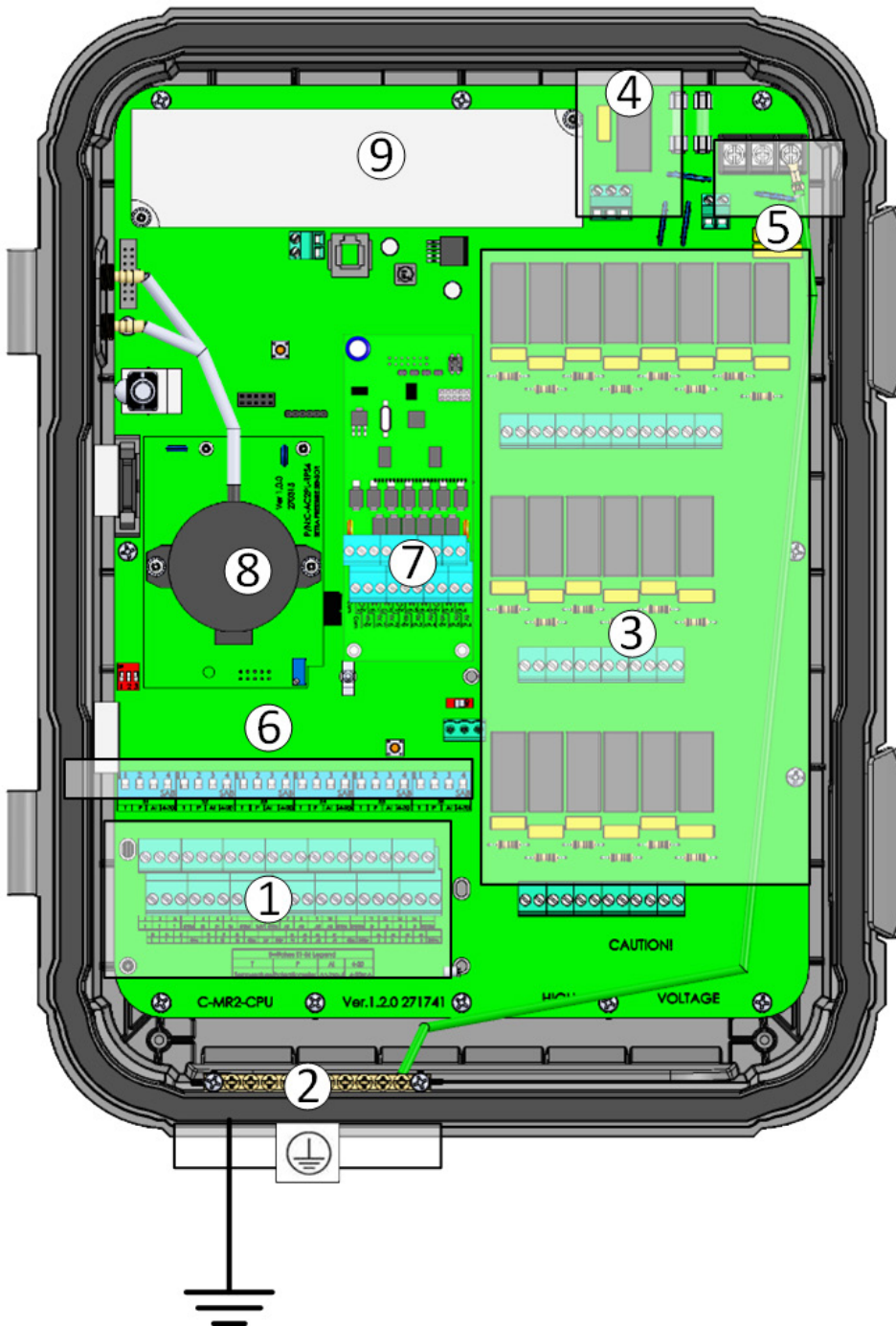

Figure 7: Main Board layout

1	Analog/digital ports	6	Dipswitches
2	Ground strip	7	Scale Card (option)
3	20 relays	8	Pressure Sensor
4	Alarm relay	9	Heat Sink
5	Power ports	10	Power Supply

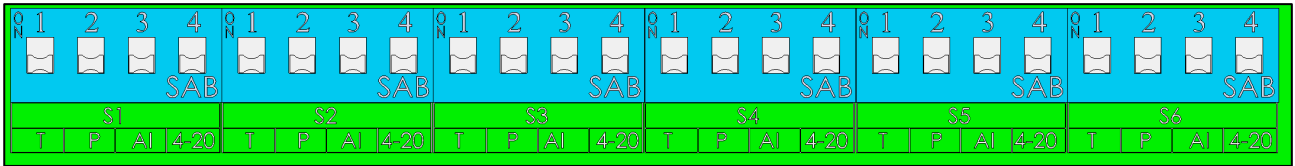

Figure 8: Dipswitches, expanded

- One dipswitch only in each set is raised.
- Only raise a dipswitch if a device is wired to an S port.

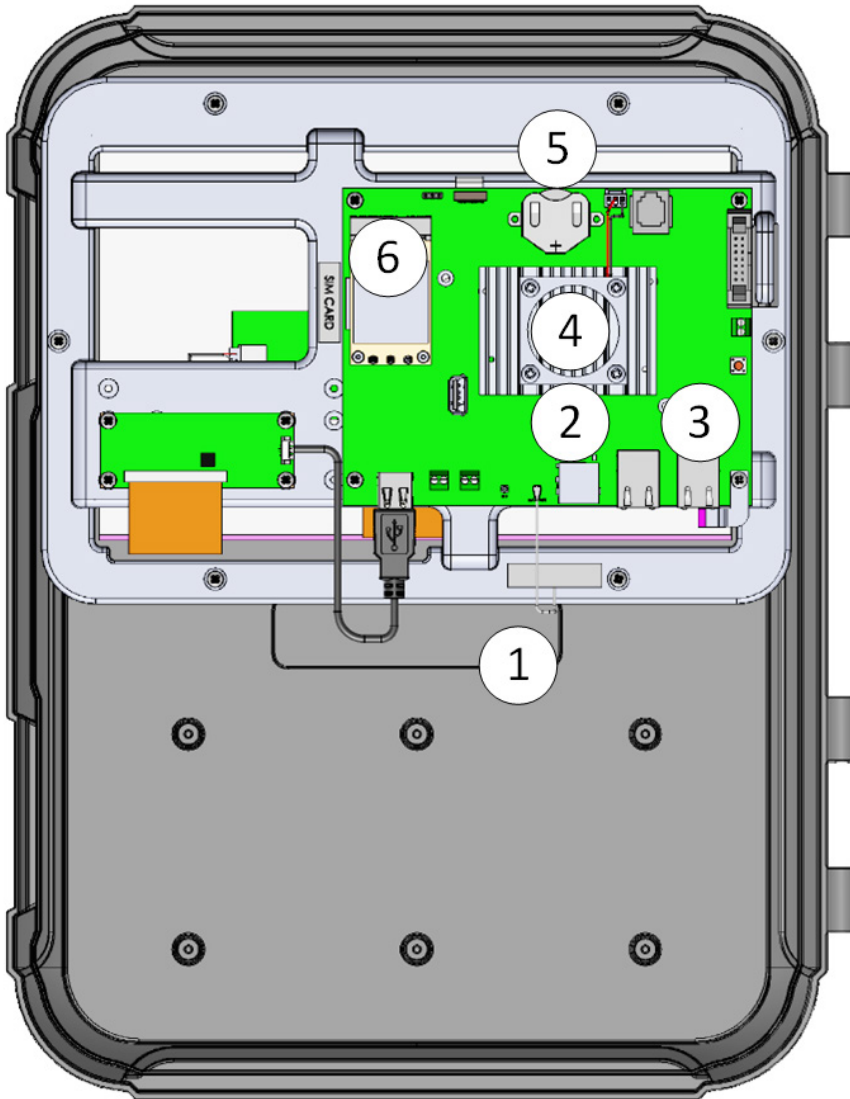

Figure 9: Display Board layout, Display Card Version 1.1.0

1	Wireless antenna
2	SD Ports
3	Ethernet Port
4	Heat Sink
5	3V Battery
6	Modem

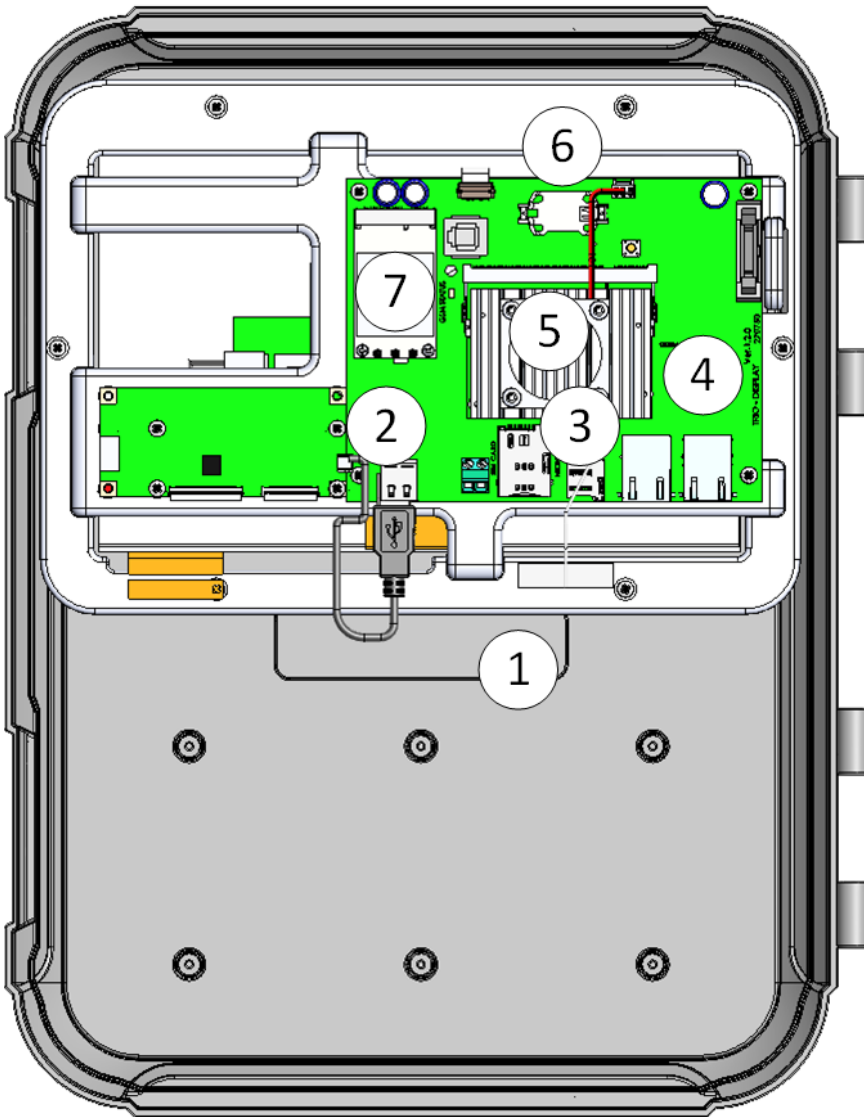

Figure 10: Display Board layout, Display Card Version 1.0.4

1	Wireless antenna
2	SIM Port
3	SD Ports
4	Ethernet Port
5	Heat Sink
6	3V Battery
7	Modem

NOTE There is no functional difference between Versions 1.0.4 and 1.1.0. All future versions will support both cards.

3.4 Wiring Diagrams

- High Voltage Relays
- Alarms and Power
- Internet Connection
- Analog Output Devices
- Digital Devices
- Analog Input Devices
- Trio RPS
- Bird Scale Card
- Silo Wiring
- RSU Wiring
- RLED 2.0 Wiring

NOTE After physically installing and connecting the external input/output devices, perform a Cold Start (System > General Settings > About > Reset Factory Default). Map the devices after the Cold Start.

3.4.1 HIGH VOLTAGE RELAYS

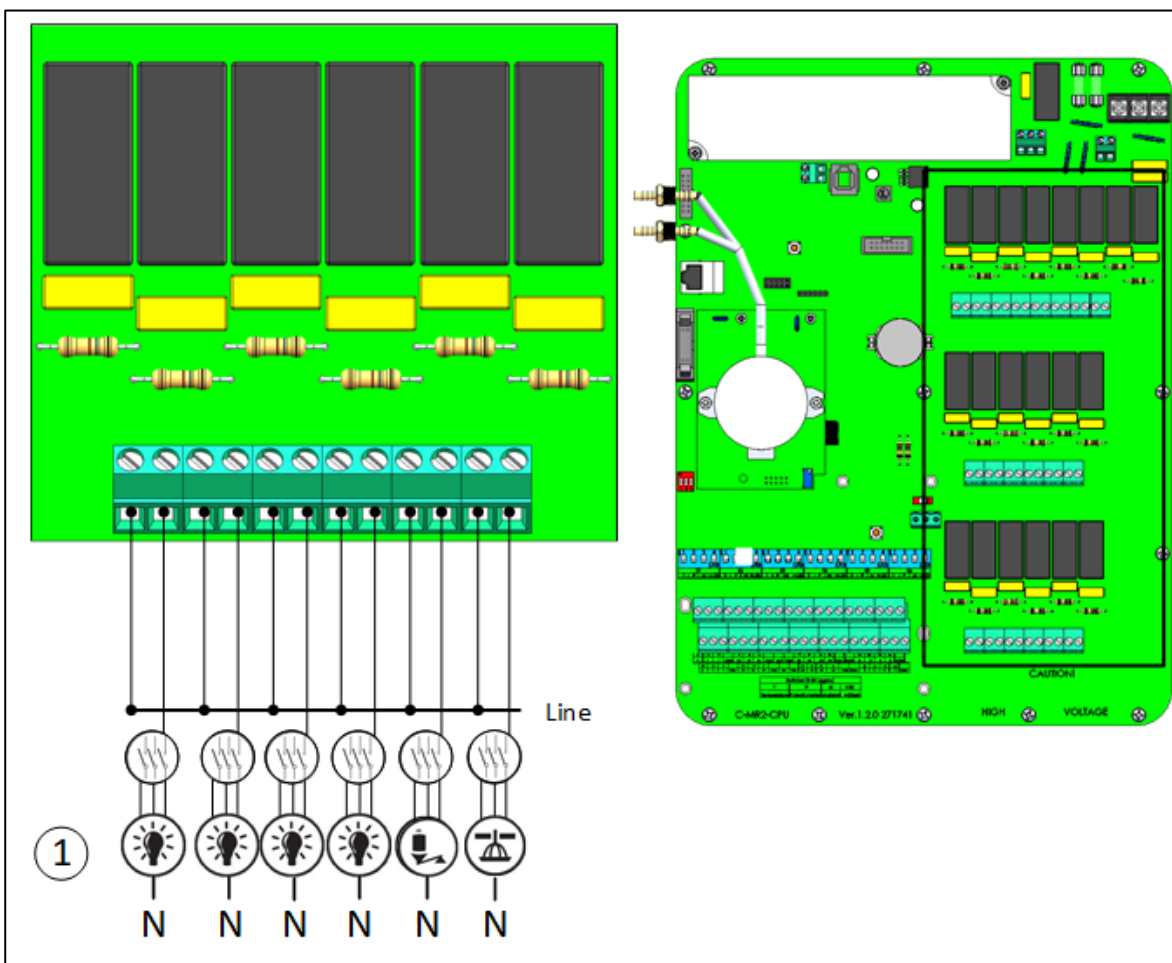

Figure 11: High voltage devices (examples)

1	Example of devices
---	--------------------

NOTE The relays control motors and heating devices via contactors, not directly.

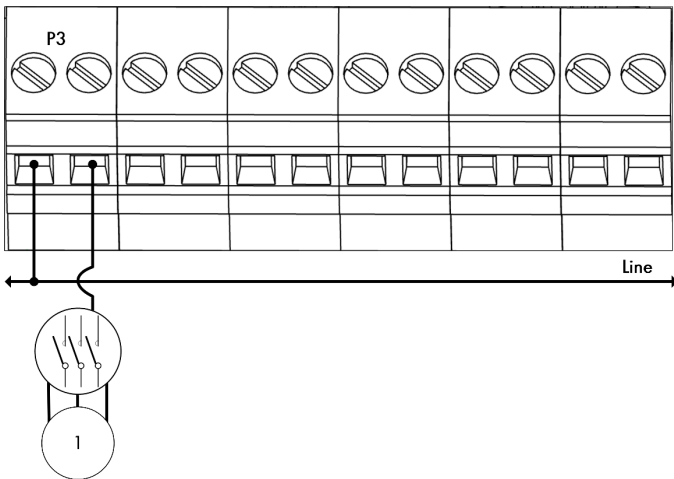

Figure 12: Relay wiring detailed view

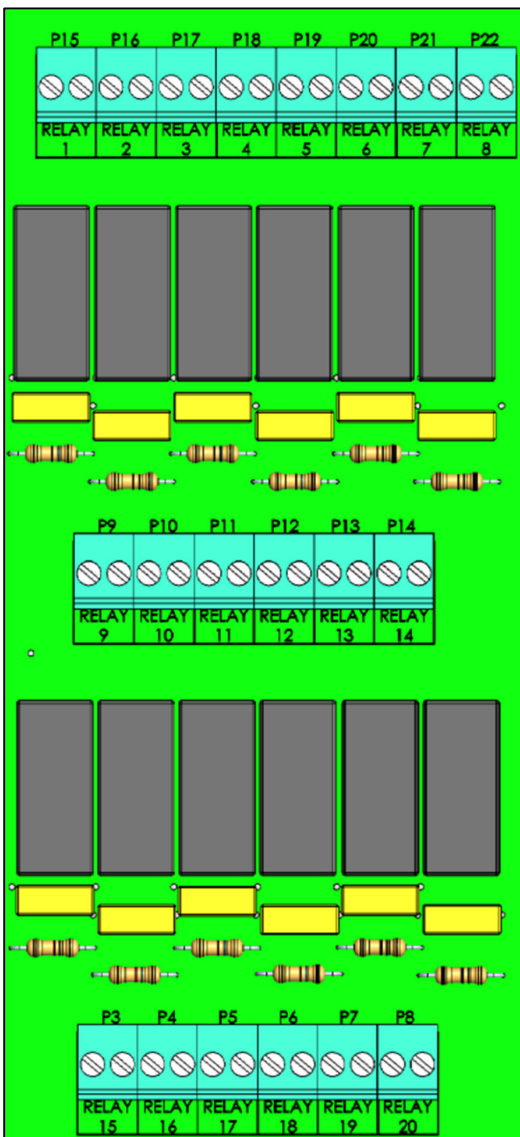

Figure 13: Relay and port numbering

3.4.3 INTERNET CONNECTION

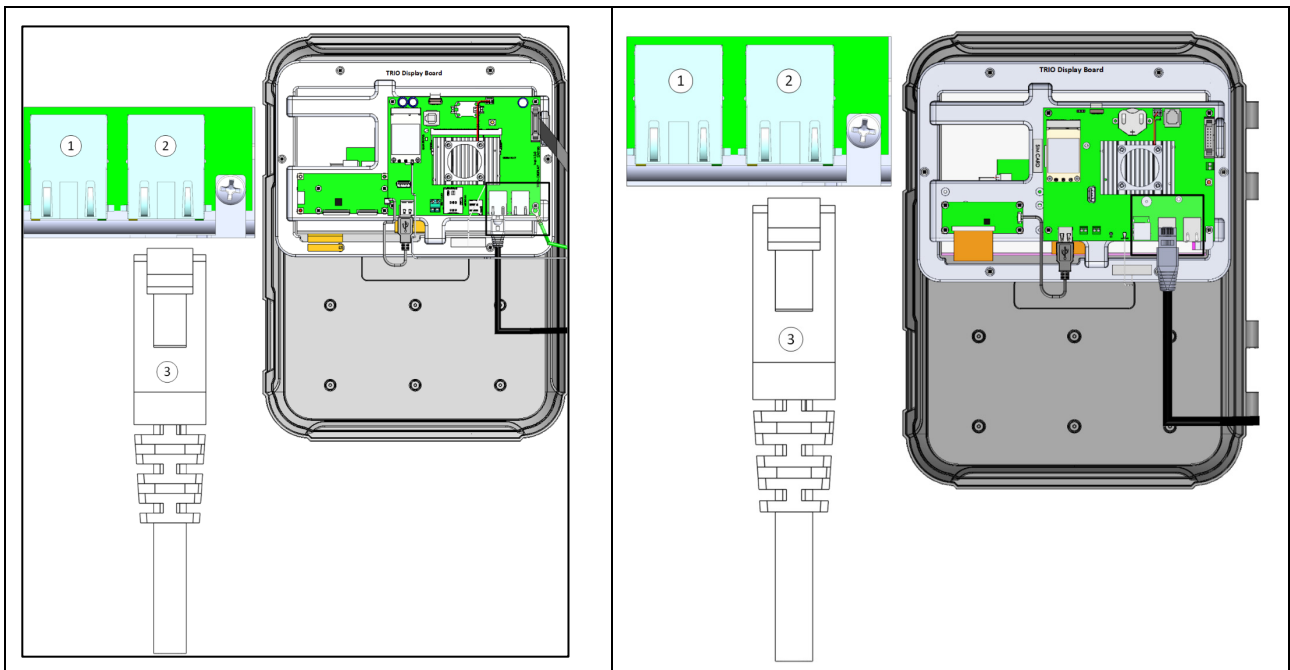

Figure 15: Ethernet port, Display Card Versions 1.0.4 and 1.1.0

CAUTION Connect the internet cable to port 2. Do not connect the cable to port 1.

1	Internal port (do not use this port)
2	Ethernet port
3	RJ-45 cable

3.4.4 ANALOG OUTPUT DEVICES

Trio supports analog control over a variety of devices.

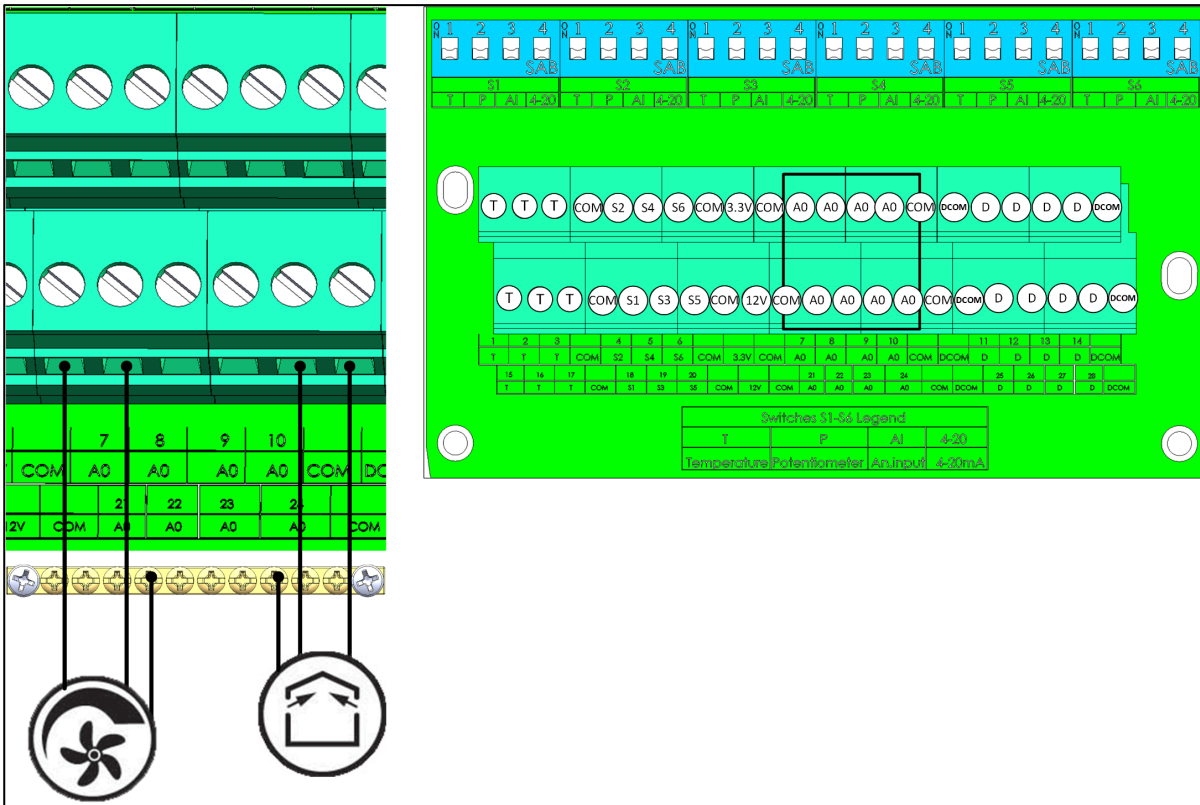

Figure 16: Analog Output devices (examples)

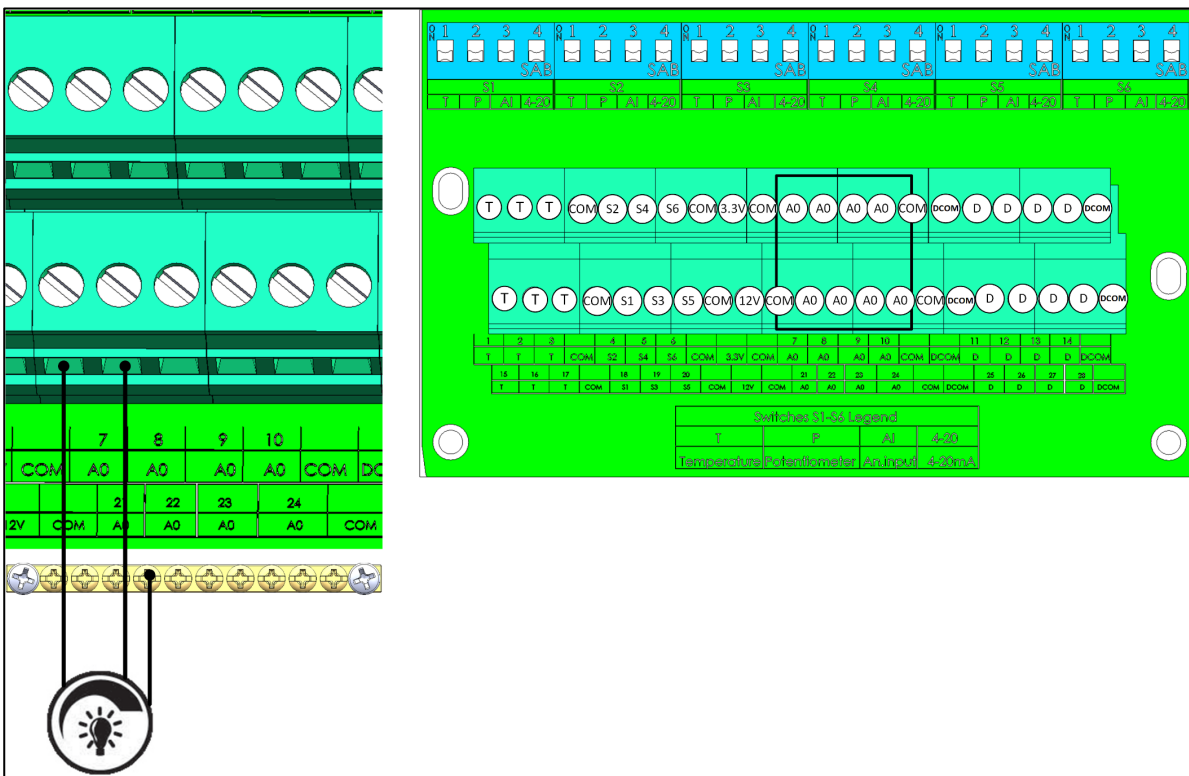

Figure 17: Light Dimmer devices

- Connect analog output devices to an AO and a COM port. Ground these devices!

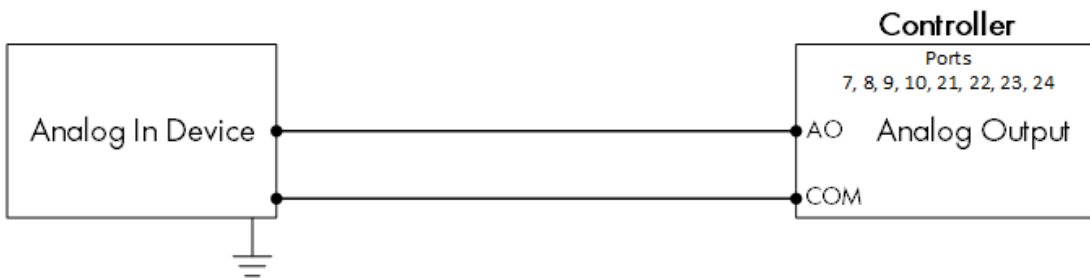

Figure 18: Analog Device Wiring Schematic

3.4.5 DIGITAL DEVICES

Trio supports a variety of digital inputs.

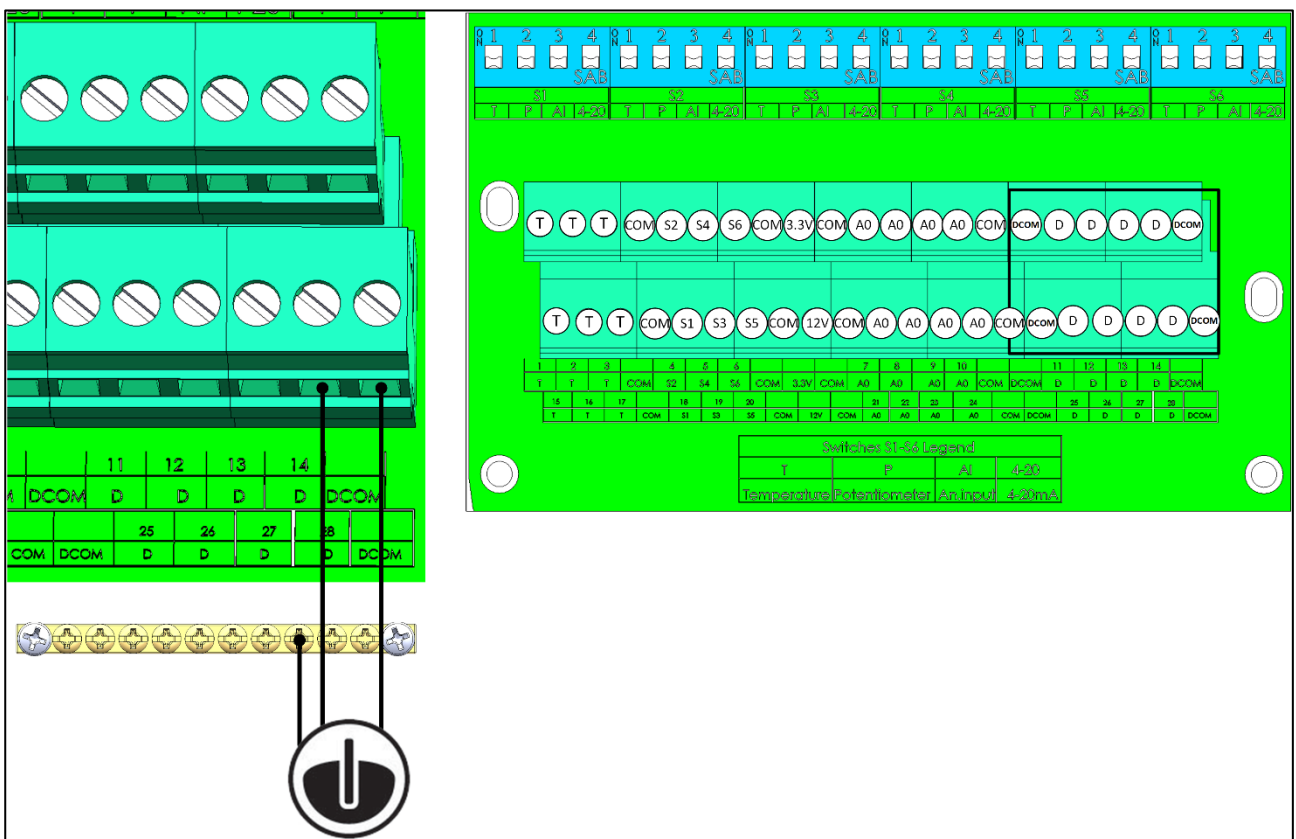

Figure 19: Digital Input devices (example)

- Connect digital devices to a D port and a DCOM port. Ground these devices!

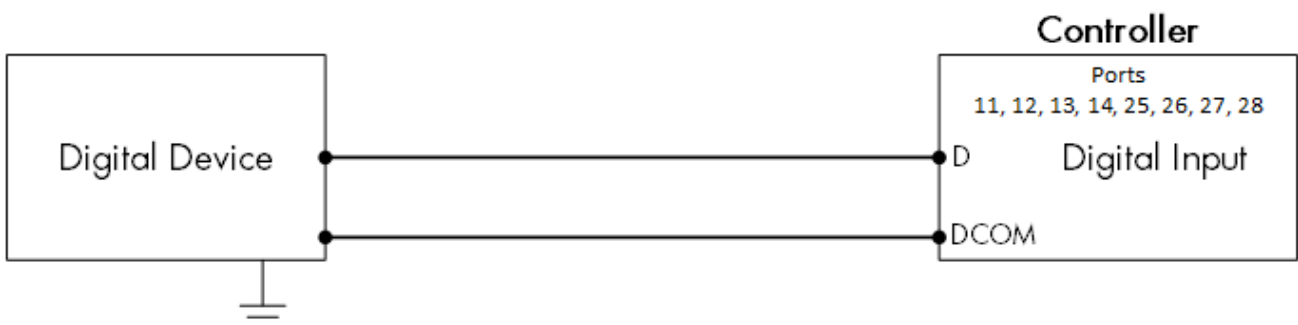

Figure 20: Digital Device Wiring Schematic

3.4.6 ANALOG INPUT DEVICES

- CO2 Sensor Wiring
- Temperature Sensor Wiring
- Humidity Sensor Wiring
- Potentiometer Wiring
- Ammonia Sensor Wiring
- Light Sensor Wiring

3.4.6.1 CO2 Sensor Wiring

Refer to the [CO2 Sensor Manual](#) for details on installing this unit.

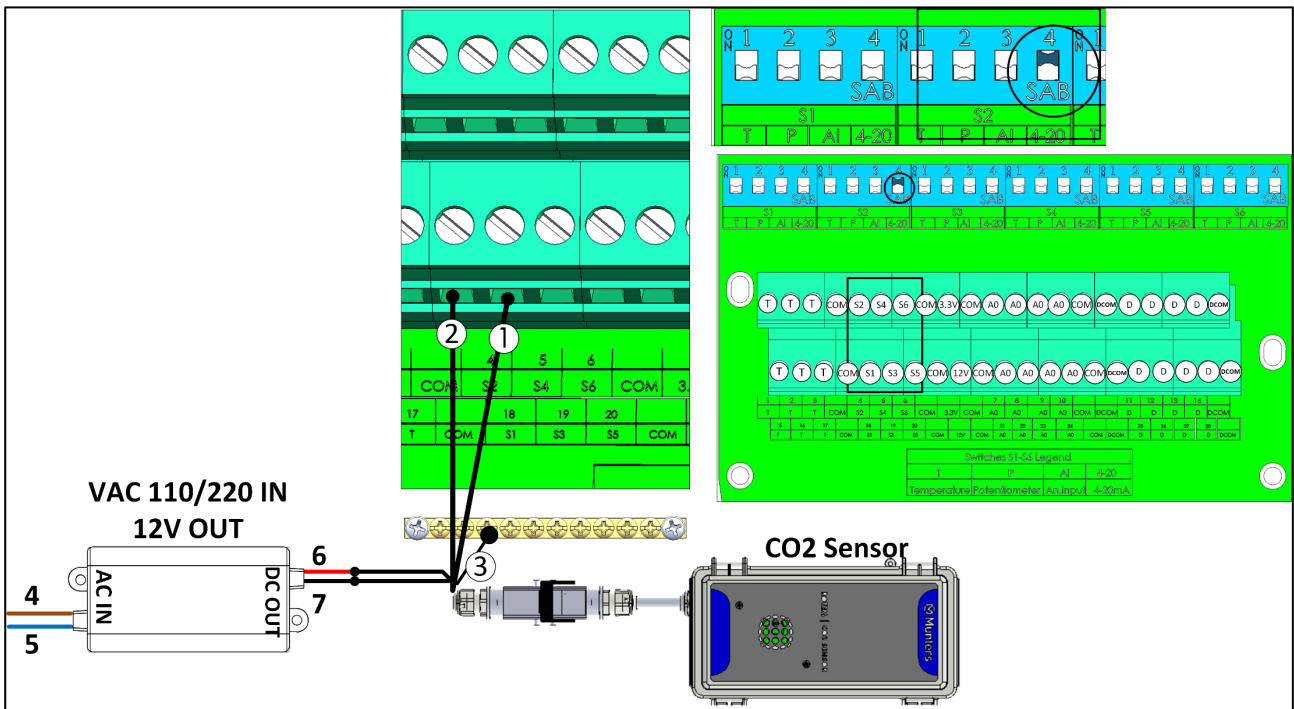

Figure 21: CO2 Sensor Wiring

Number	Function
1	S port
2	COM port
3	Shield wire
Power Supply	
4	COM port Brown wire: phase
5	Shield wire Blue wire: neutral
6	Red wire: +12V
7	Black wire: -12V (Sig COM)

CAUTION Connect the shield to the safety ground.

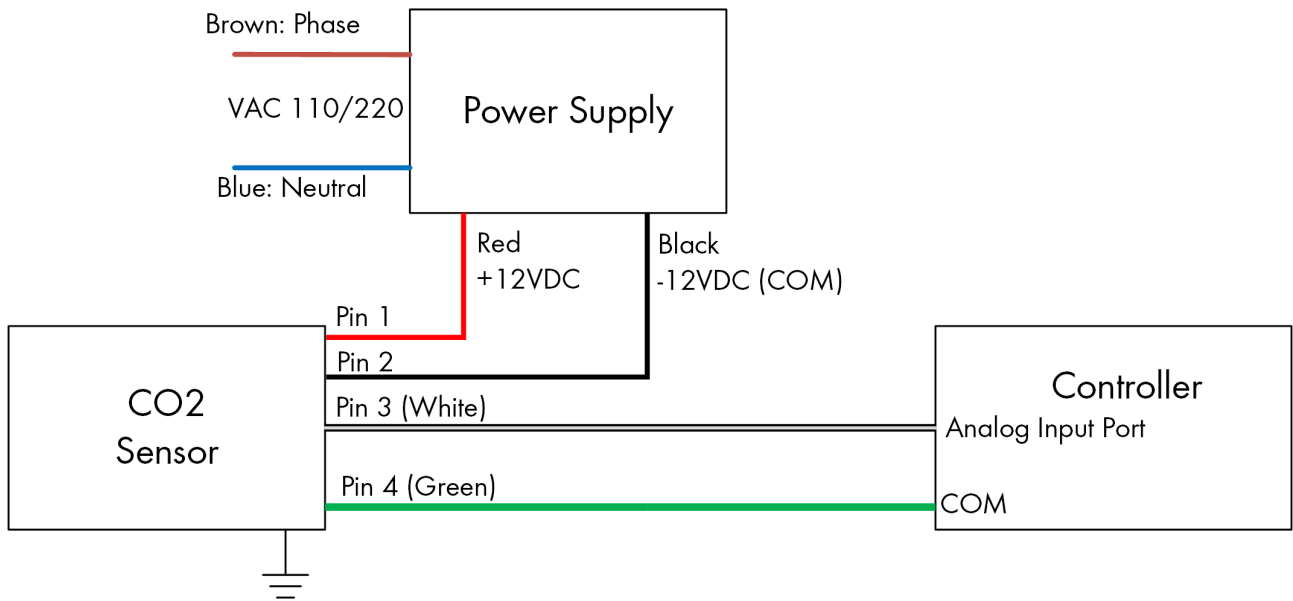

Figure 22: CO2 Sensor Wiring Schematic

- Connect the CO2 device to:
 - Controller:
 - S port. In the corresponding dipswitch, raise dipswitch 4 (4-20 mA).
 - COM port
 - Grounding strip!
 - Power supply
 - +12V
 - -12V

3.4.6.2 Temperature Sensor Wiring

Refer to the [RTS-2 Manual](#) for details on this sensor.

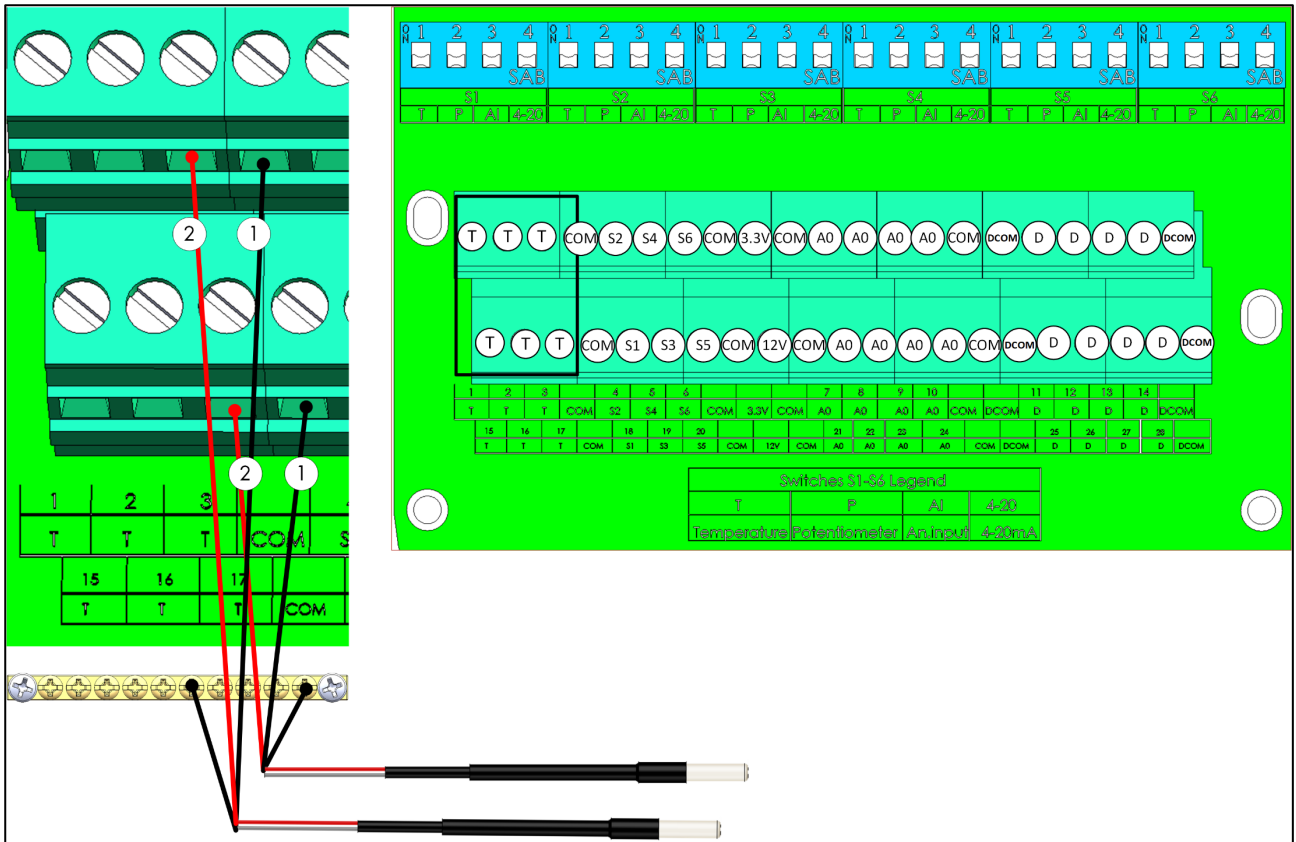

Figure 23: RTS Wiring

Number	Function
1	COM port (black wire)
2	T port (red wire)

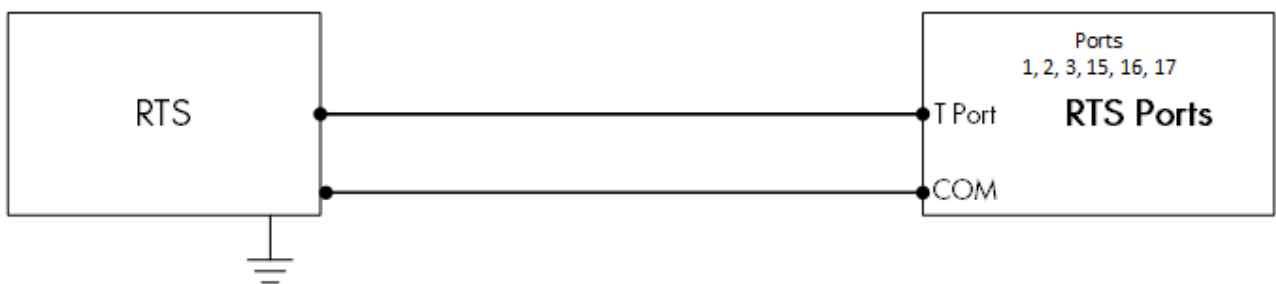

Figure 24: RTS Wiring Schematic

- Connect each RTS sensor to a:
 - T port
 - COM port
 - Grounding strip!
- Note:
 - Wire all designated T ports before wiring the RTS sensors to the S ports.
 - Connect the black wire to a COM port, not a DCOM port.

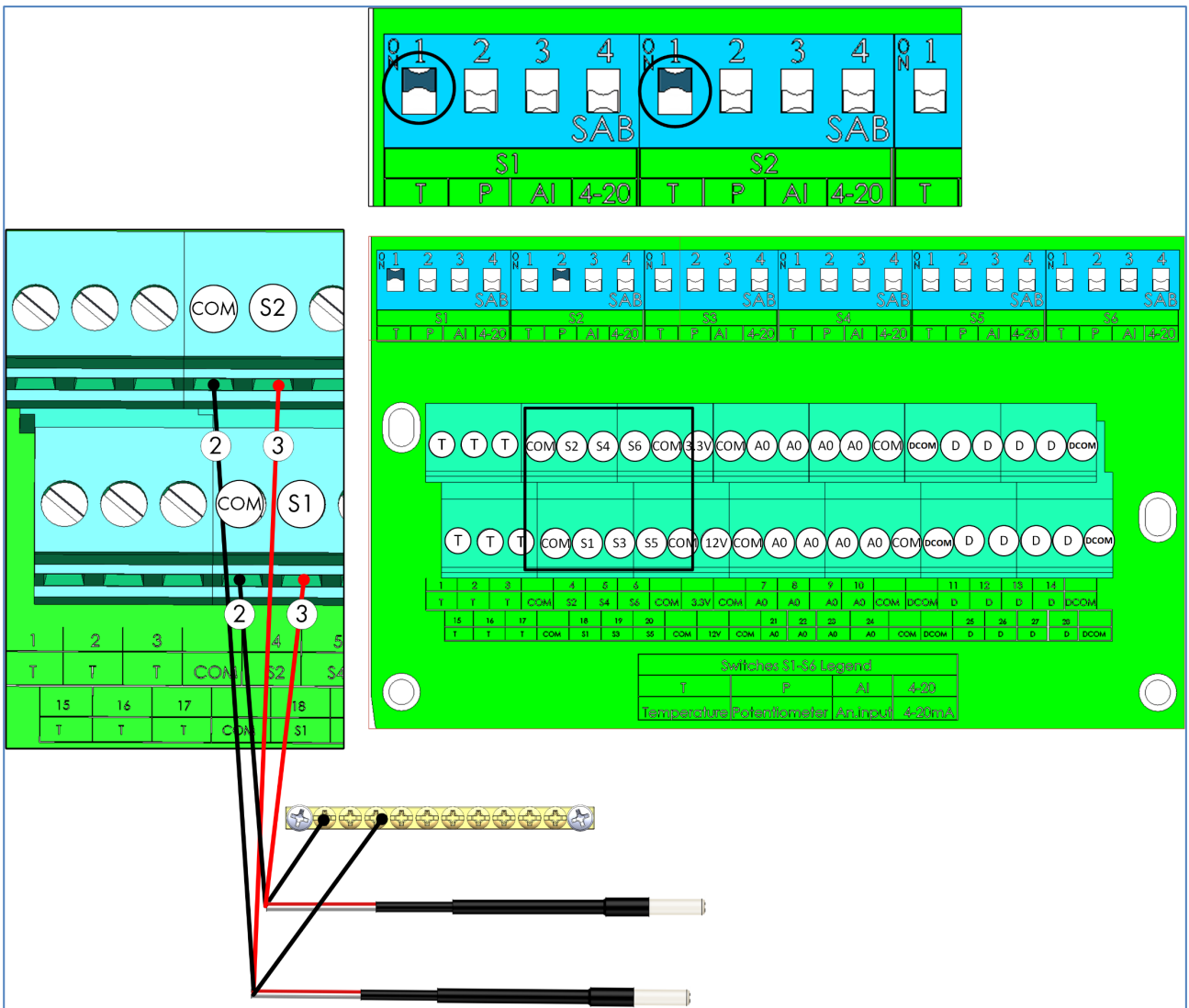

Figure 25: RTS S Port Wiring

Number	Function
2	COM port (black wire)
3	S port (red wire)

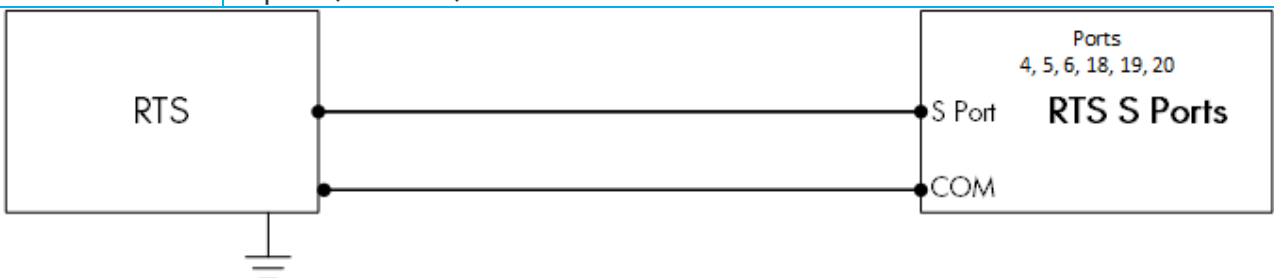

Figure 26: RTS S Port Wiring Schematic

- Connect each RTS sensor to a:
 - S port. In the corresponding dipswitch, raise dipswitch 1 (temp)
 - COM port
 - Grounding strip!
- Note:
 - Wire all designated T ports before wiring the RTS sensors to the S ports.
 - Connect the black wire to a COM port, not a DCOM port.

Number	Function
1	COM port (black wire)
2	12V (red wire)
3	S port (white wire)
4	Shield wire

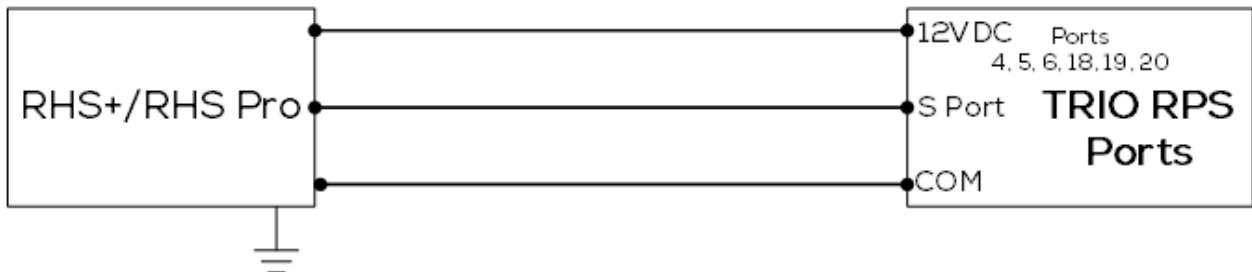

Figure 29: RHS+/Pro Sensor Wiring Schematic

- Connect each RHS+/Pro sensor to a:
 - S port. In the corresponding dipswitch, raise dipswitch 3 (analog input).
 - COM port.
 - 12VDC port.
 - Grounding strip!

3.4.6.4 Potentiometer Wiring

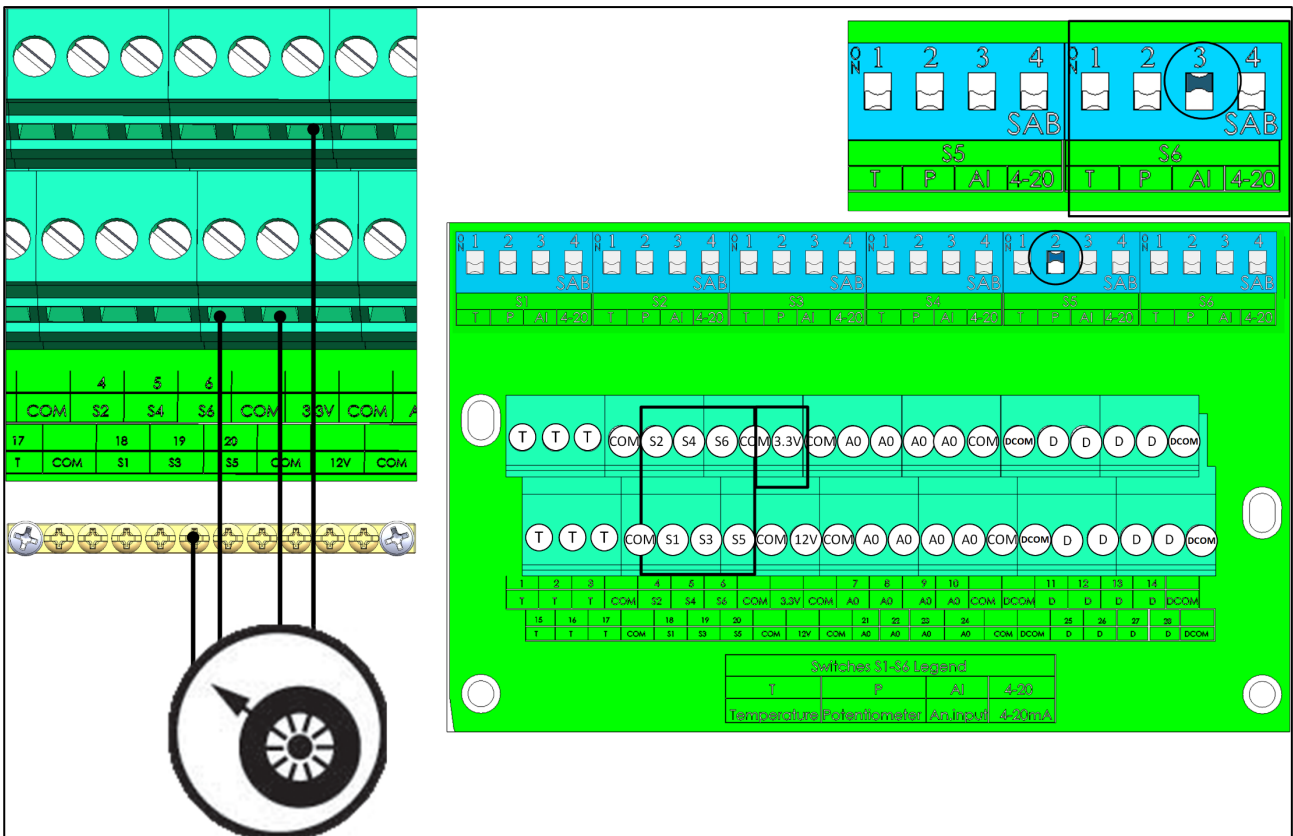

Figure 30: Potentiometer Wiring

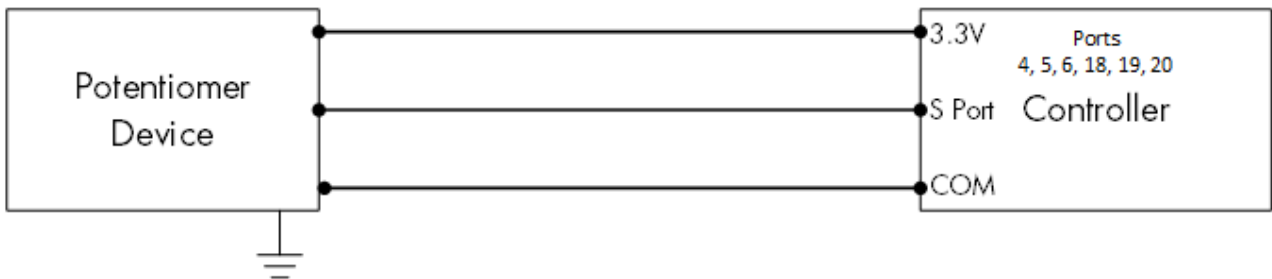

Figure 31: Potentiometer Wiring Schematic

- Connect each potentiometer to a:
 - S port. In the corresponding dipswitch, raise dipswitch 2 (potentiometer).
 - COM port.
 - 3.3V port.
 - Grounding strip!

3.4.6.5 Ammonia Sensor Wiring

Refer to the [Ammonia Sensor manual](#) for further information.

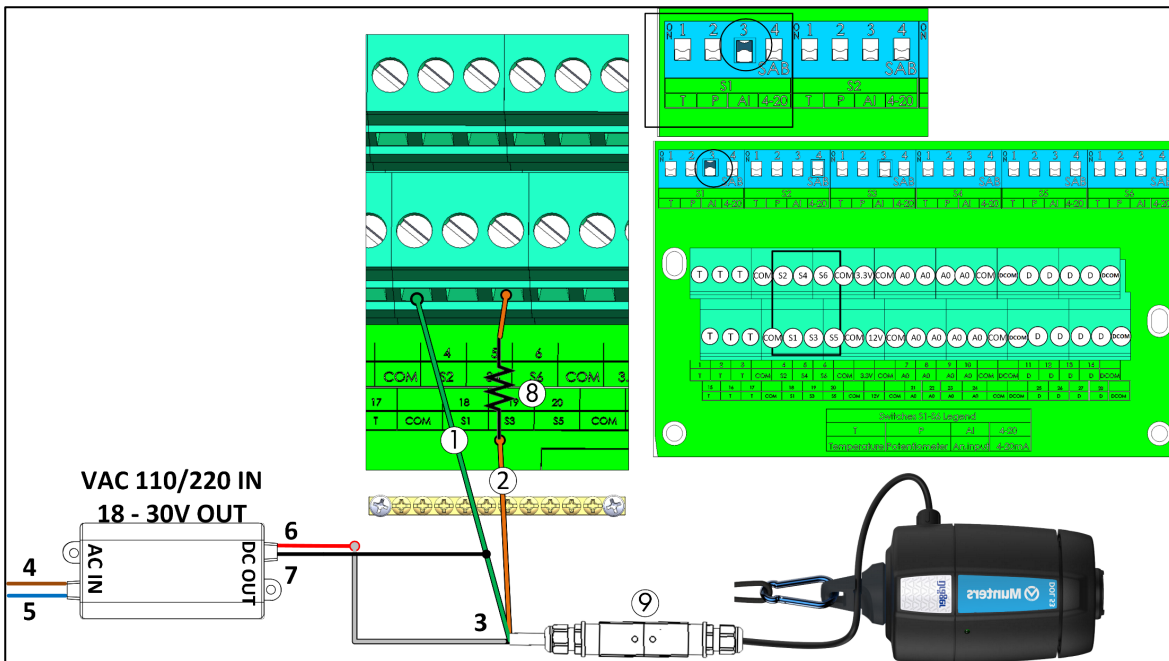

Figure 32: Ammonia Sensor Wiring

No.	Function
1	COM port (Green wire)
2	S port (Brown wire)
3	White wire
4	Phase (Brown wire)
5	Neutral (Blue wire)
6	18-30VDC (Red wire)
7	COM (Black wire)
8	20.3 kohm resistor (Note: The resistor comes supplied with the sensor but must be installed on-site)
9	Quick connector

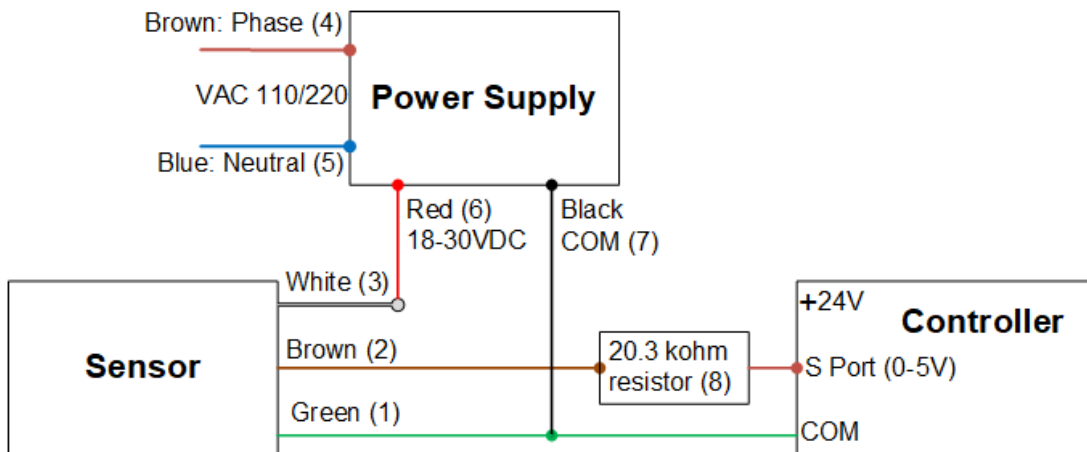

Figure 33: Ammonia Wiring Schematic

- Connect an ammonia sensor to a:
 - S port. In the corresponding dipswitch, raise dipswitch 3 (analog input).
 - COM port.
 - Grounding strip!

3.4.6 Light Sensor Wiring

Refer to the [RLS Manual](#) for more information.

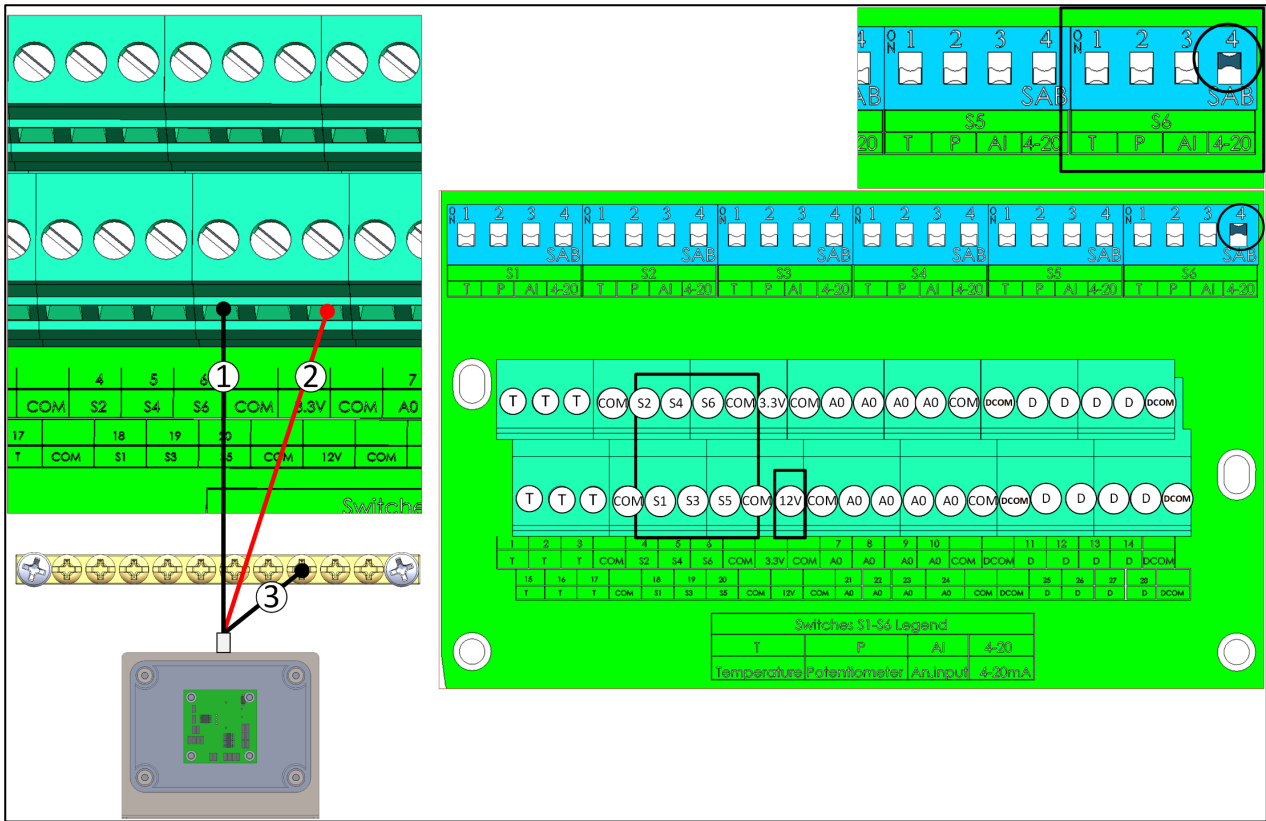

Figure 34: Light Sensor Wiring

Number	Function
1	S port (black wire)
2	12V (red wire)
3	Shield wire

- Connect each RLS sensor to a:
 - S port. In the corresponding dipswitch, raise dipswitch 4 (4 -20 mA).
 - 12VDC port.
 - Grounding strip!

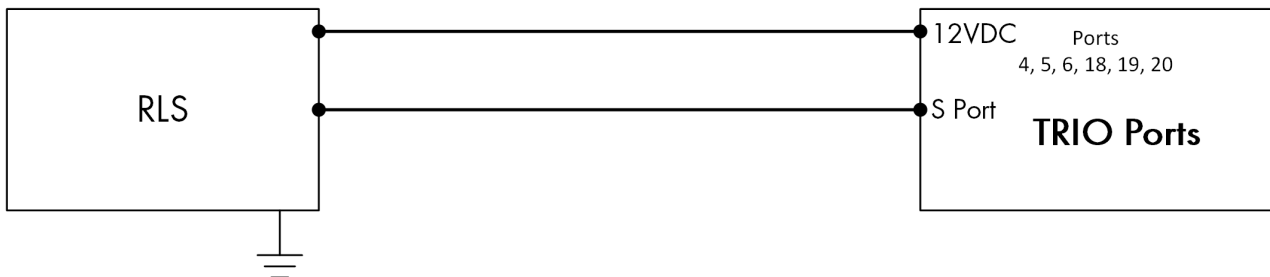

Figure 35: RLS Wiring Schematic

3.4.7 TRIO RPS

Trio RPS serves as a second static pressure sensor for the Trio Controller. The following section details the installation. Trio supports up to two static pressure sensors, one built in and one external. Install the RPS in the second house.

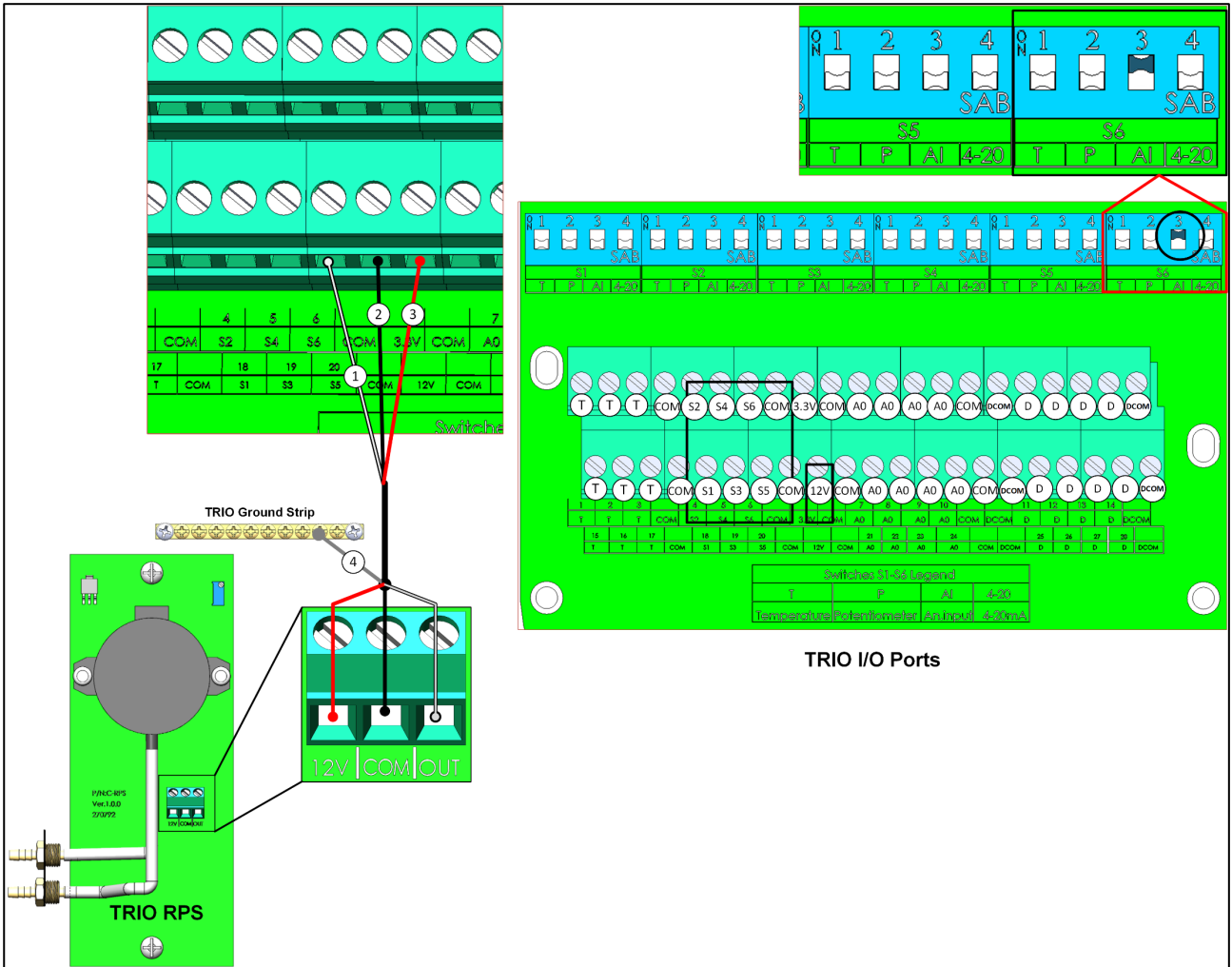

Figure 36: RPS Wiring

Number	Function
1	S port. Raise the corresponding S3 dipswitch.
2	COM port
3	12V
4	Shield wire

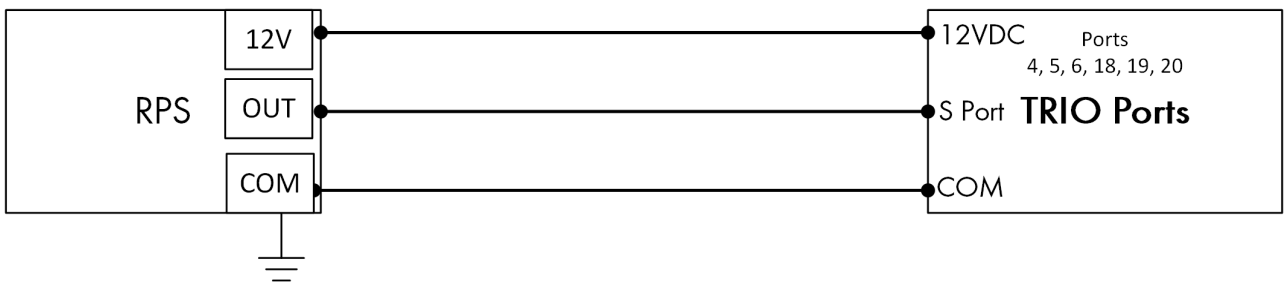

Figure 37: RPS Wiring Schematic

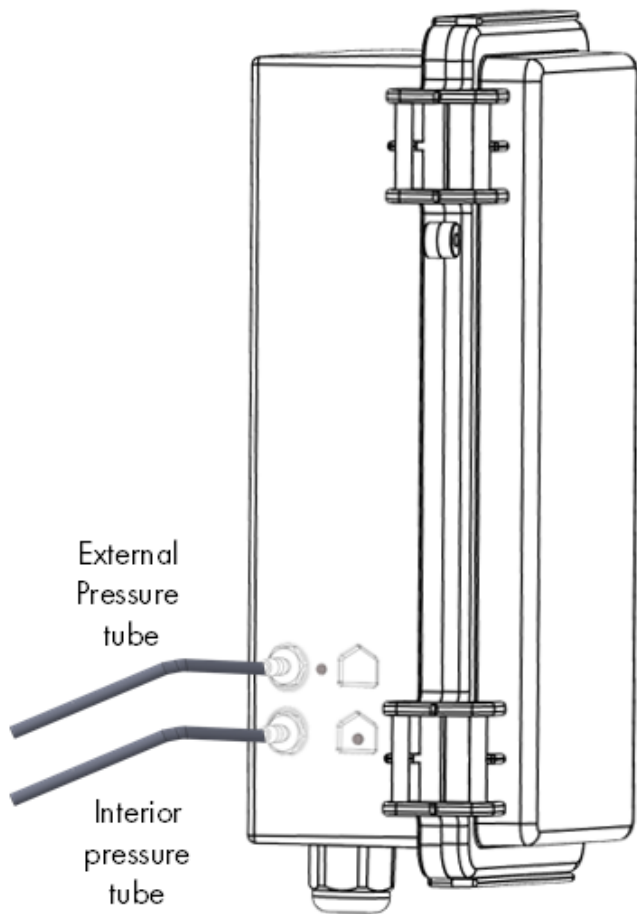

Figure 38: Static pressure tubes

NOTE After installing the RPS, no Cold Start is required.

3.4.8 BIRD SCALE CARD

If you install a scale card, perform a cold start. Refer to the User Manual.

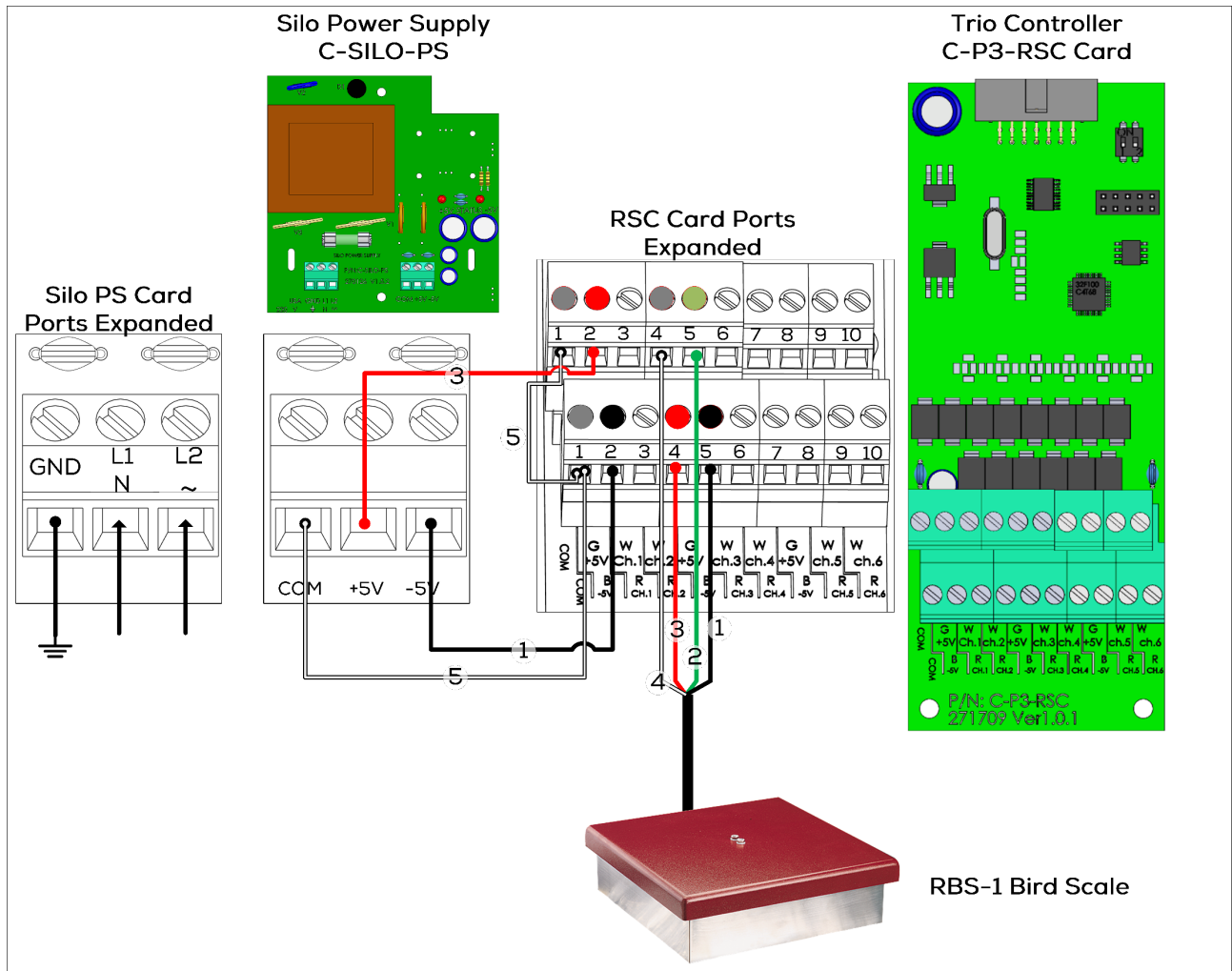

Figure 39: Scale Card wiring to Power Supply and Bird Scale

Number	Function
1	Black wire, -5V
2	Green wire, +5V
3	Red, Channel 1 - 6
4	White, Channel 1 - 6
5	COM

NOTE Connect each RBS-1 white and red wire to matching RSC ports; for example White Ch.1 and Red Ch. 1.

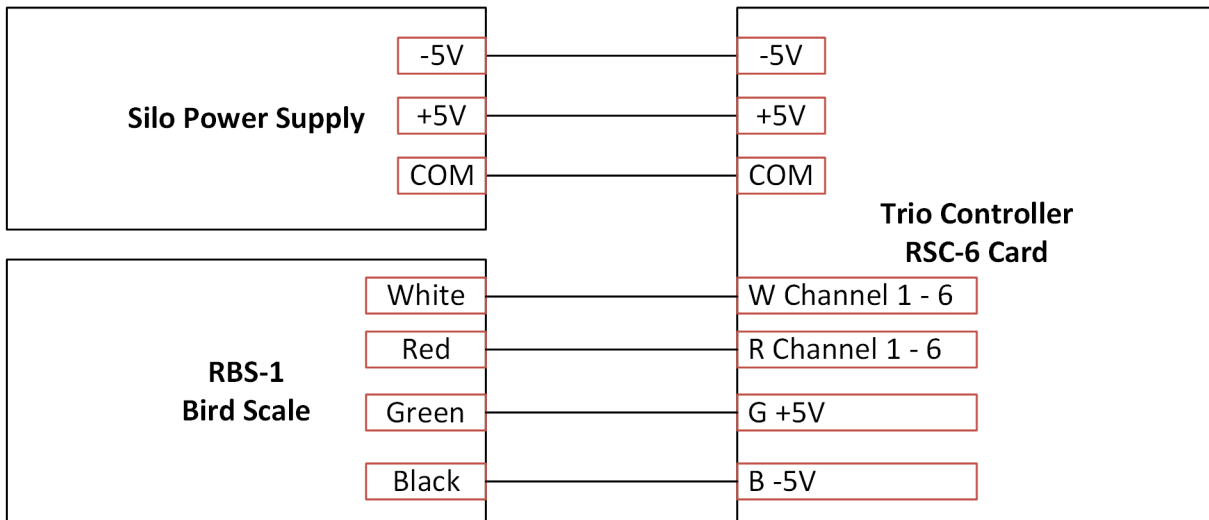

Figure 40: RSC Card to Silo Power Supply/RBS-1 Schematic

3.4.9 SILO WIRING

Wire the Trio to an RJB Junction Box and power supply. For details on how to wire the Junction Box to the load cells, refer to the RJB manual.

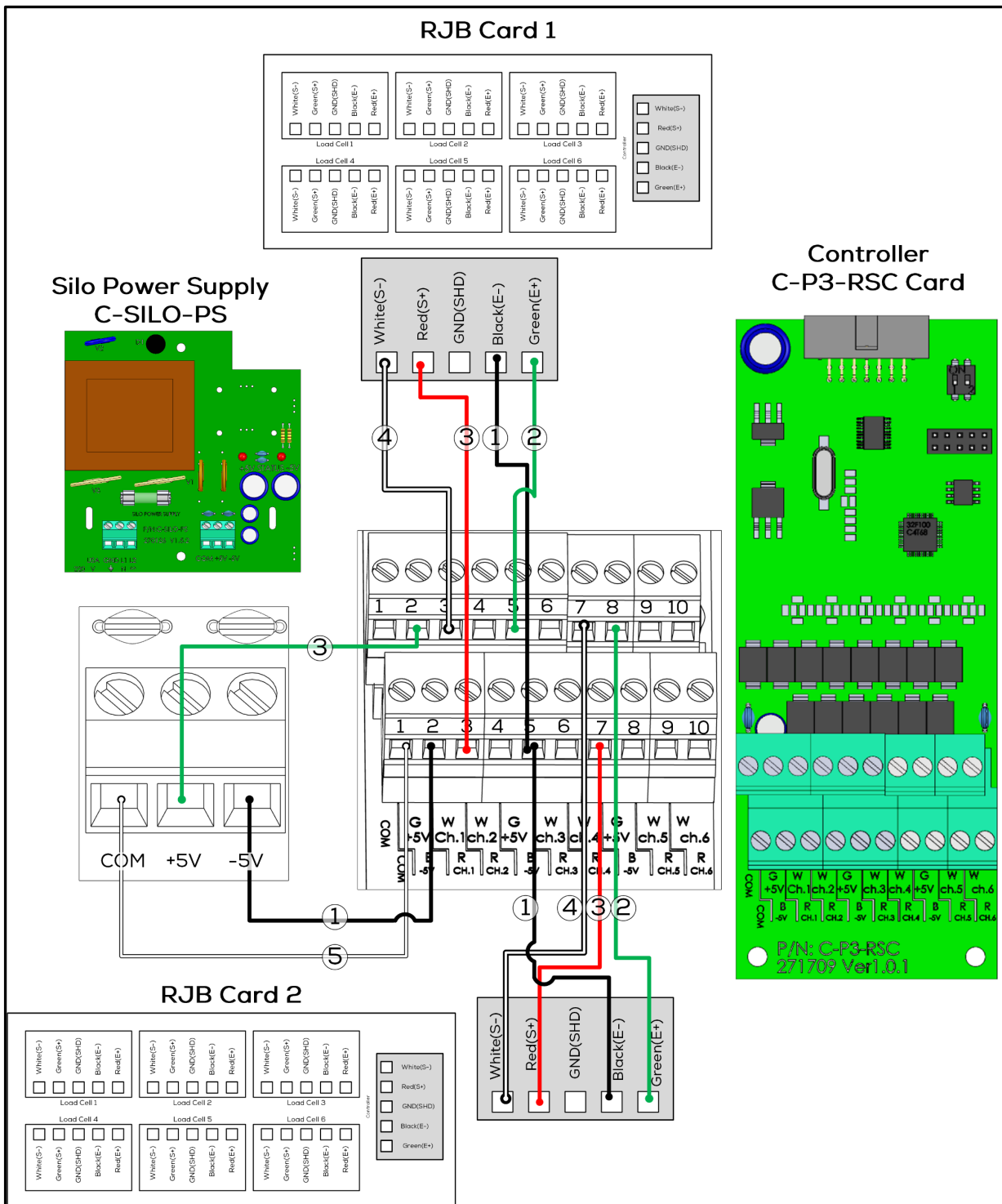

Figure 41: Scale Card Wiring to Power Supply and RJB-6

NOTE Connect each RJB-6 white and red wire to matching RSC ports; for example White Ch.1 and Red Ch. 1.

Number	Function
1	Black wire, -5V
2	Green wire, +5V
3	Red, Channel 1 - 6
4	White, Channel 1 - 6
5	COM

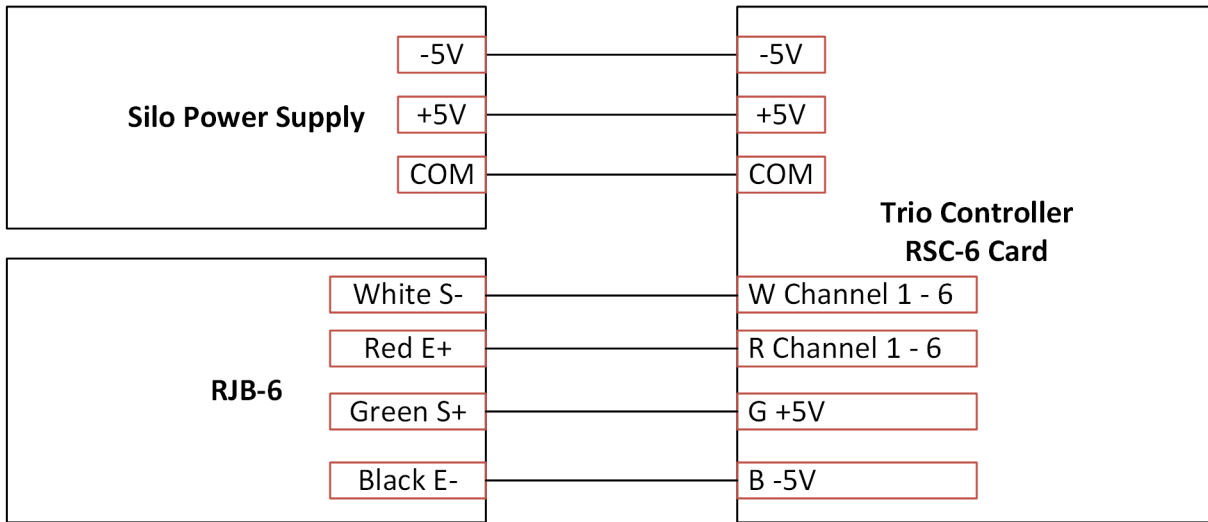

Figure 42: RSC Card to Silo Power Supply/RJB-6 Schematic

RJB Wire	RSC Ports	
Green	2, 5, 8 (Upper)	
Black	2, 5, 8 (Lower)	
White	3, 4, 6, 7, 9, 10 (Upper)	Note: Connect each RJB white and red wire to matching ports. For example White Ch.1 and Red Ch.1
Red	3, 4, 6, 7, 9, 10 (Lower)	

3.4.10 RSU WIRING

Refer to the [RSU Manual](#) for further information.

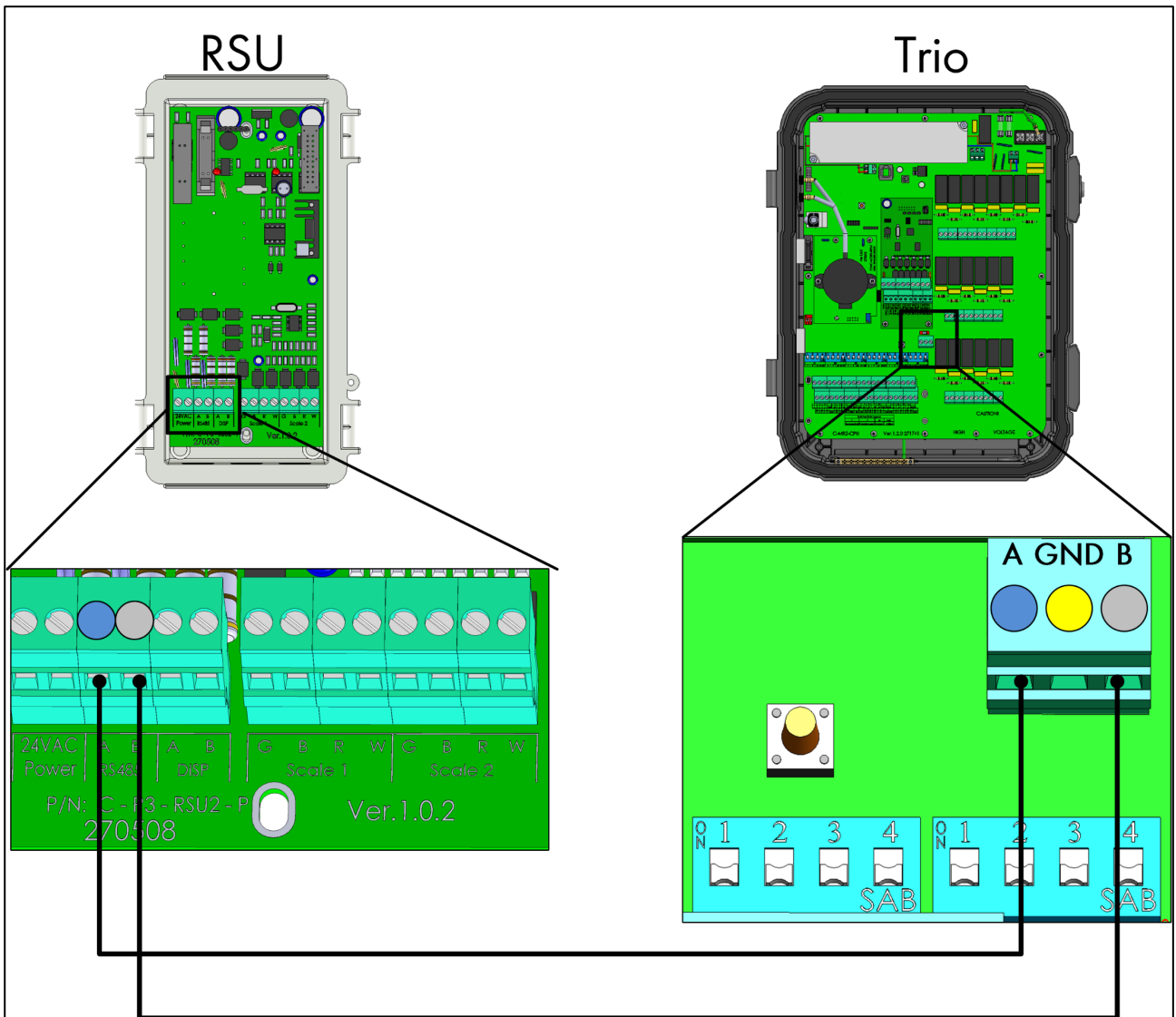

Figure 43: Trio – RSU Wiring

3.4.11 RLED 2.0 WIRING

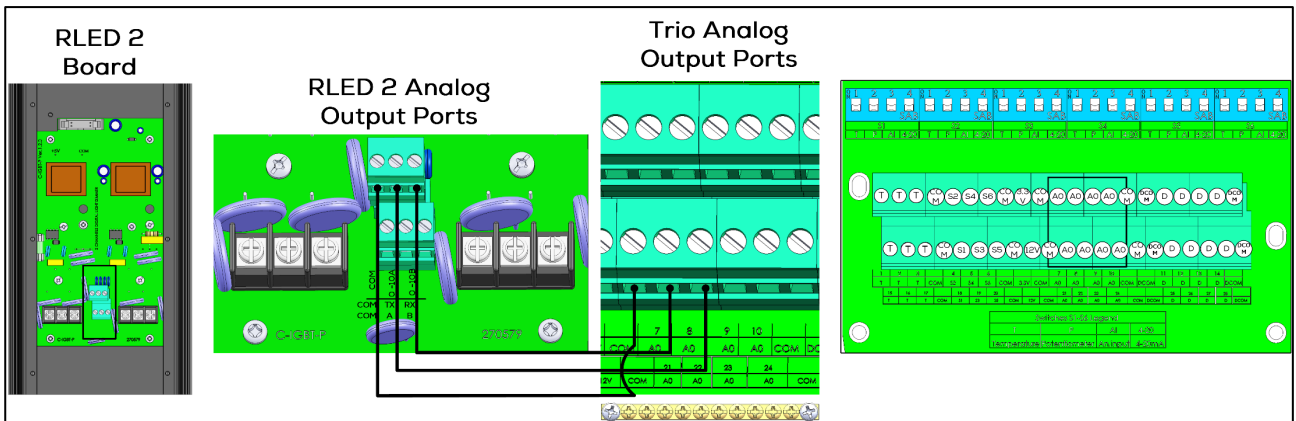
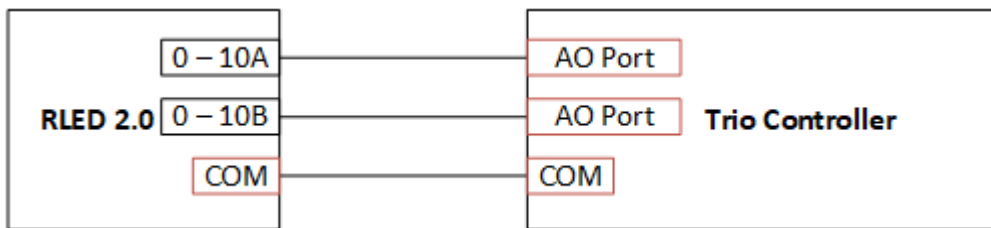

Figure 44: Trio – RLED 2.0 Wiring



3.4.12 BATCH WEIGHING

- External Batch Bin Installation
- Electronic Batch Weighing Installation

3.4.12.1 External Batch Bin Installation

- Map and define cross augers in Devices and Sensors. Refer to the Installation Manual.

Every time feed is placed into the batch weigher, Trio receives a pulse. Each pulse corresponds to a quantity of feed. The mix is generated by defining the quantities (meaning, the number of pulses) of different type of feed to be added.

- Connect the batch counter to a digital input port.

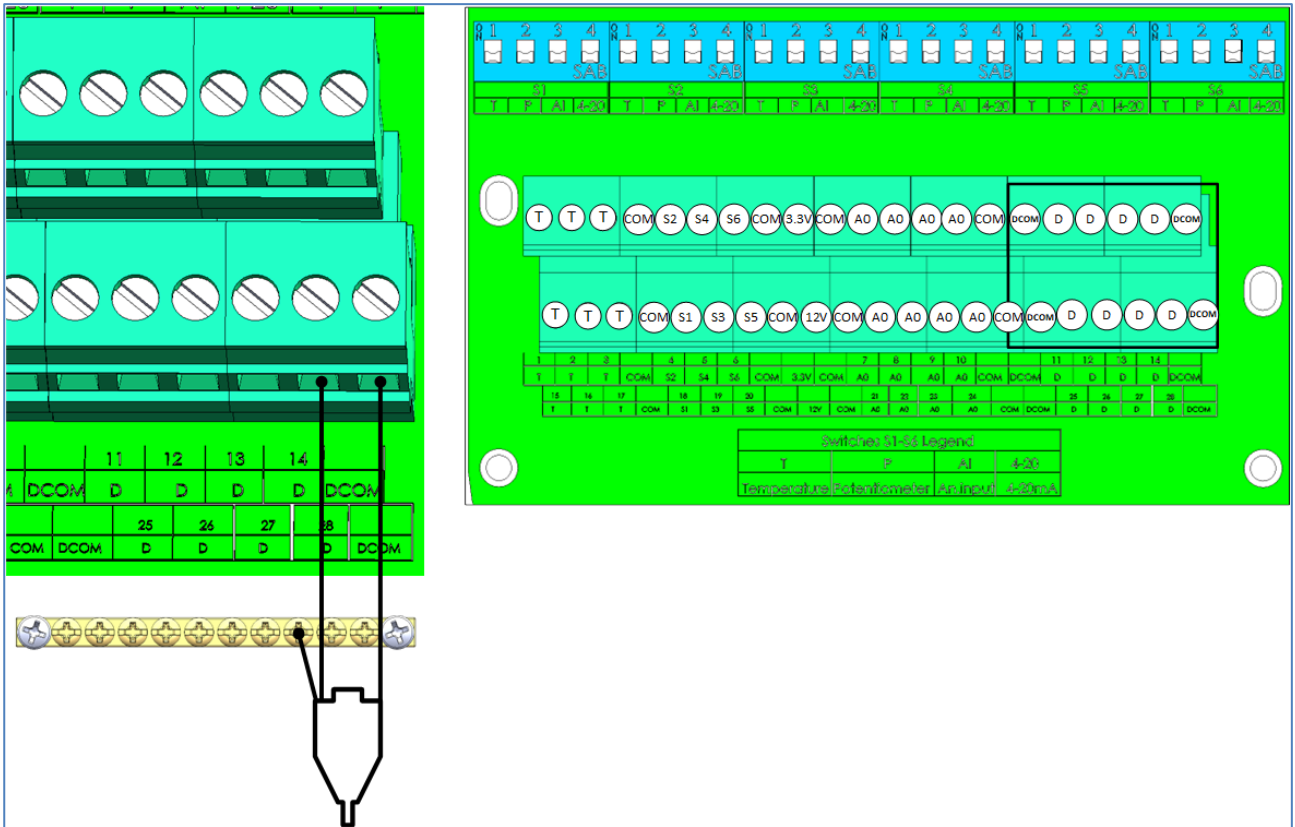

1. In System > Devices and Sensor > Installation > Sensors, define one digital port as Batch Counter.

Batch Counter 1

QTY/Pulse 1 Kg

TEST

2. Define:

- Qty/Pulse: Define the quantity of feed per pulse (designate the quantity as metric or imperial; refer to the User Manual). This quantity must match the quantities defined in the external controller.
- Click Test to ensure that the Trio connection to the batch counter is operating.

NOTE When delivering feed via an external batch bin, no silo data (inventory) is provided.

3.4.12.2 Electronic Batch Weighing Installation

- Wiring and Mapping
- Batch Bin Calibration

3.4.12.2.1 Wiring and Mapping

➔ Wire the scale card to the hopper.

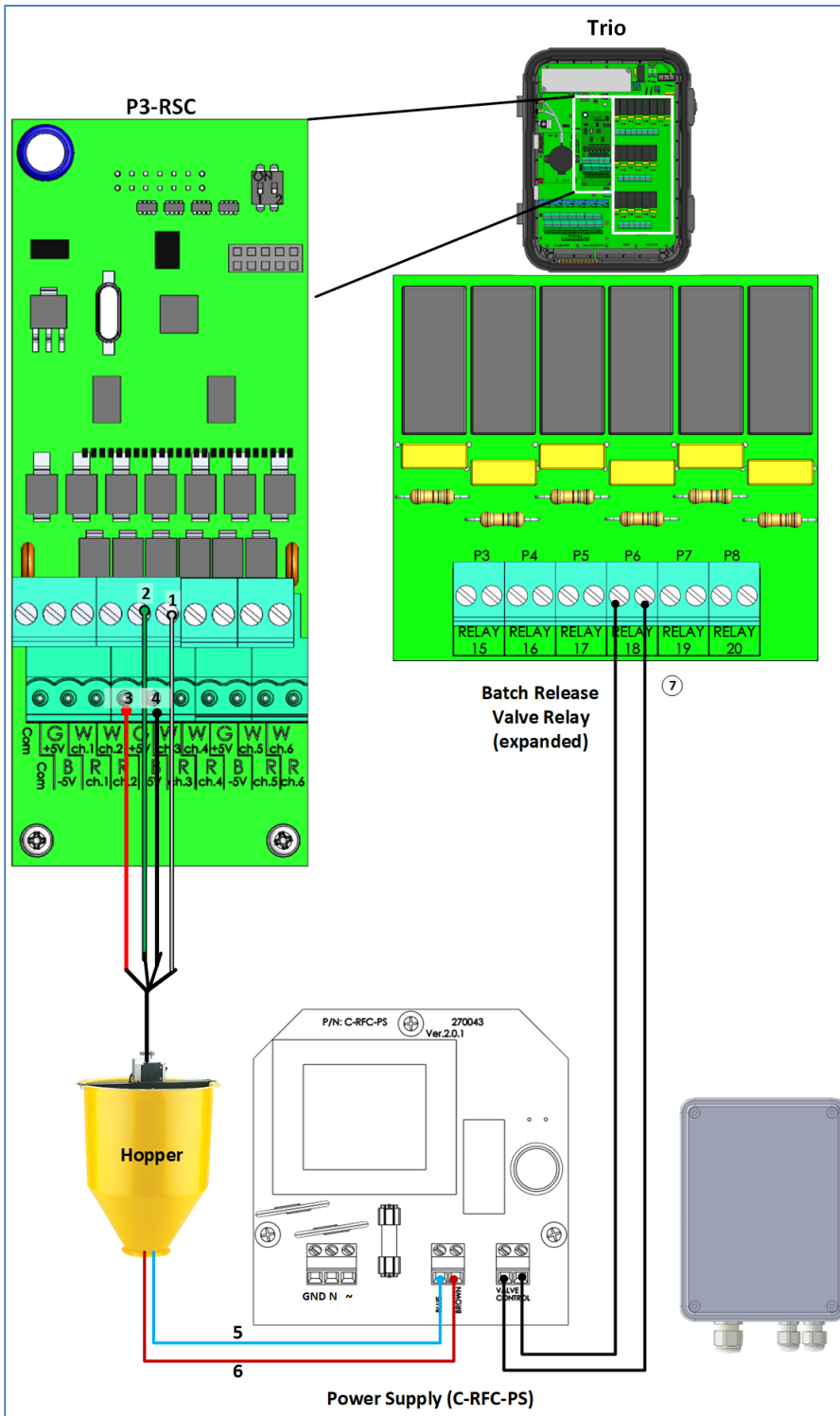

1	White wire	5	Blue wire
2	Green wire	6	Brown wire
3	Red wire	7	Trio relay ports
4	Black wire		

1. In System > Devices and Sensors > Installation > Scale, designate one scale port as Batch Weigher.

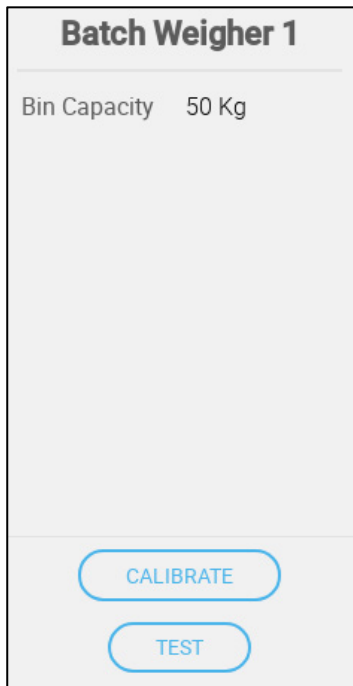

2. Define:

- Bin Capacity: Define the batch bin's capacity. Refer to the User Manual to define the units as imperial or metric. This parameter is used to determine the gain (refer to Calibration). This quantity is not related to the actual batch quantity.
- Clicking Test shows the following values:
 - Measured weight
 - Real time A/D
 - Error status
- Calibrate the weigher. Refer to Batch Bin Calibration, page 54.

NOTE Once the bin capacity is defined, any change will require recalibrating the batch weigher.

3. In System > Devices & Sensors > Installation > Scales define up to three relays as Silos.

Silo 1

Storage Capacity	0 Kg
------------------	------

CALIBRATE

TEST

4. Define:

- Storage Capacity: Define the capacity of the silo mapped to this auger (Silo Auger 1 – Silo 1, etc.).

NOTE This parameter is hidden when Silo Weight is used to manage the feed inventory.

5. In System > Devices & Sensors > Installation, define up to three relays as Silo Augers.

Silo Auger 3

Default Output	Normally Open
Feed Per Minute	0 Kg
Silo Capacity	0 Kg
KWh	0

TEST

6. Define:

- Default Output: Define the relay's default state, normally open or normally closed.
- Feed Per Minute: Define the amount of feed per minute that the silo auger sends to the batch weigher.

- Default Output: Normally open or normally close.
- Seconds to close Valve: Define the amount of time required for the release valve to go from opened to closed. Range: 0 – 255. Default 10.
- Test checks the relay functionality.

NOTE Testing stops the weigher process.

3.4.12.2.2 Batch Bin Calibration

1. On the Batch Weigher sensor screen, click **Calibrate**.

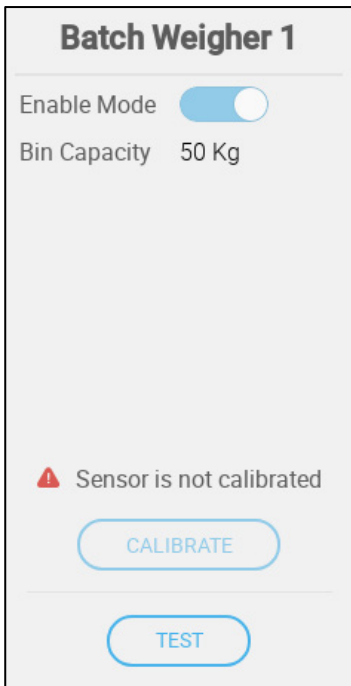

2. In the following screen, enter the bin capacity (the weight of the bin when empty, shown in the previous screen). Click **Next**.

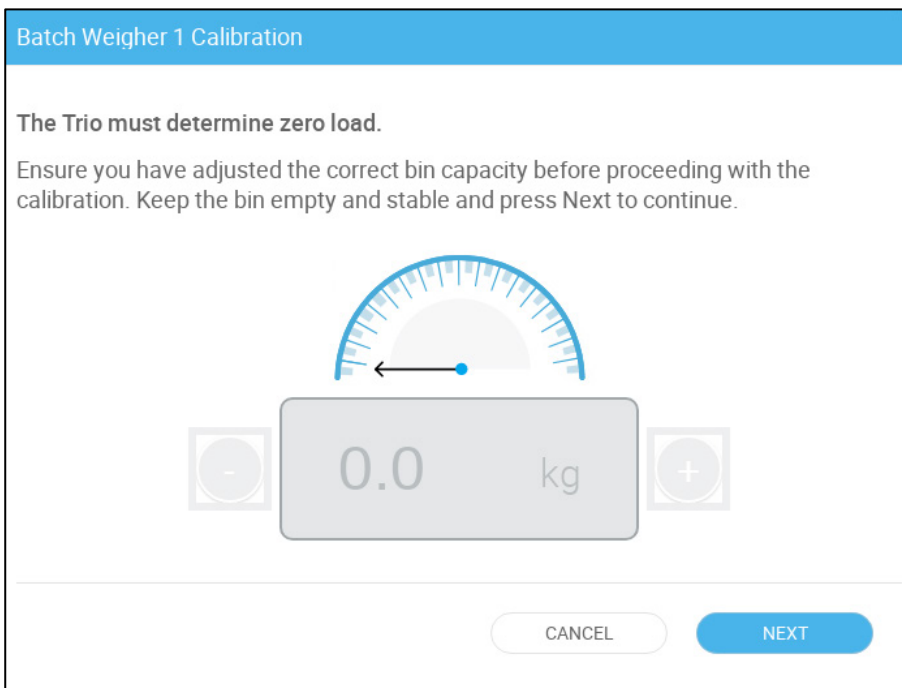

CAUTION When you press Next, the batch weigher bin opens and any feed in the weigher spills out!

3. In the following screen, place a weight (between 1 – 10 kilograms/2 – 22 pounds) and enter the gain. Click Next.

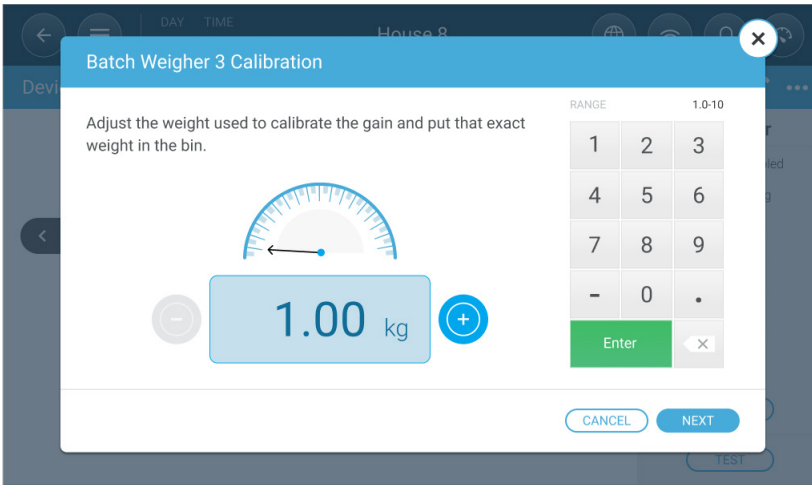

The following screen appears.

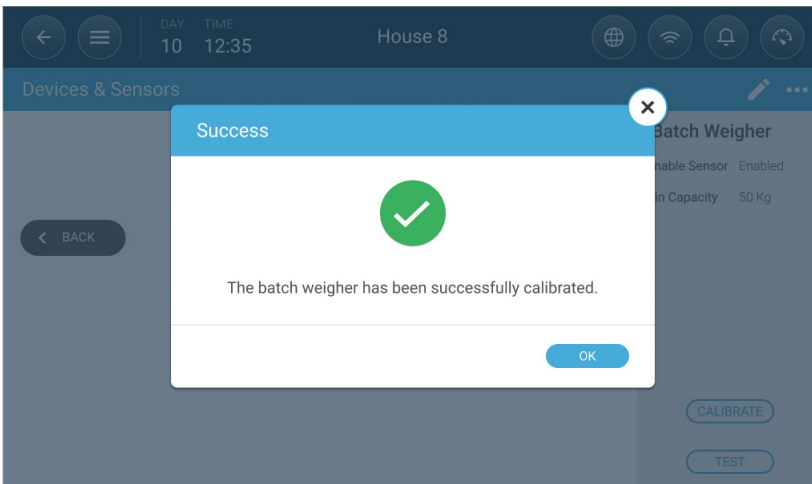

3.5 Trio – RSU/RLED 2.0 Wiring Termination

Termination, installing or enabling 120-ohm termination resistors at the beginning and end units of a chain, ensures reliable communication in RS-485 infrastructures.

Termination is recommended when the distance between Trio and the final device in the chain is more than 50 meters/165 feet. Trio and Trio Expansion come with a switch to enable termination; an external resistor must be installed on the RSU communication card. Termination may not be required in shorter installations.

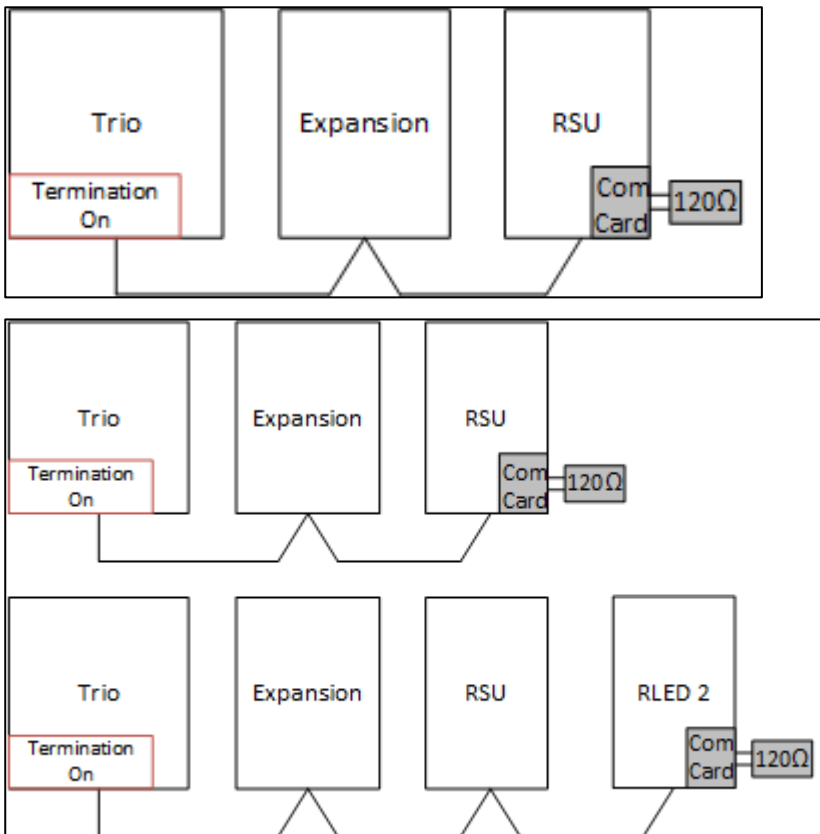

Figure 45: Termination Sample Topologies

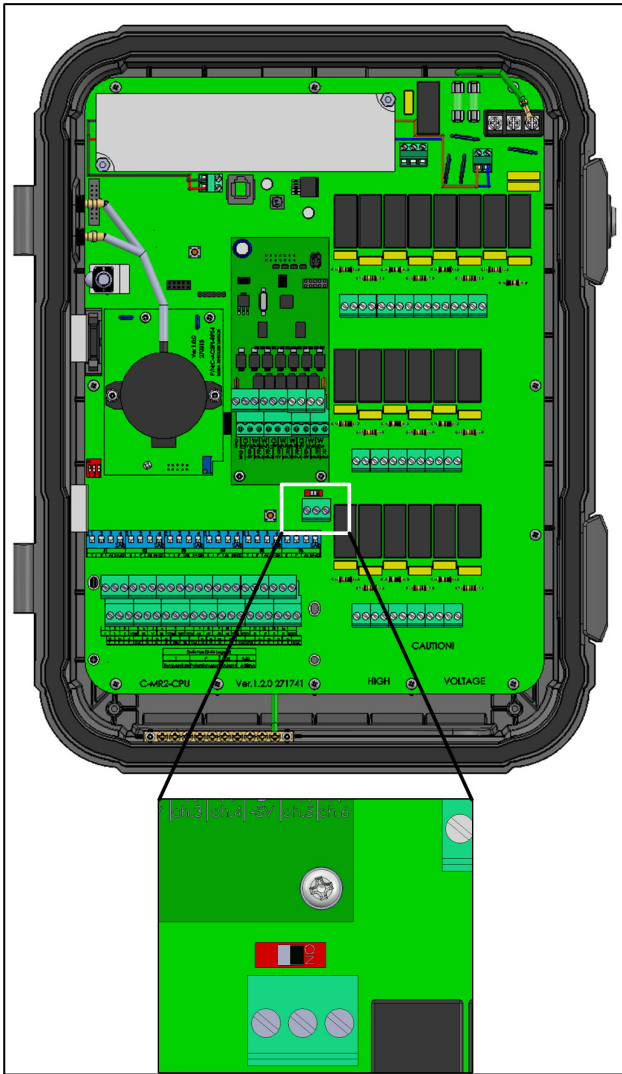

Figure 46: Termination Switch

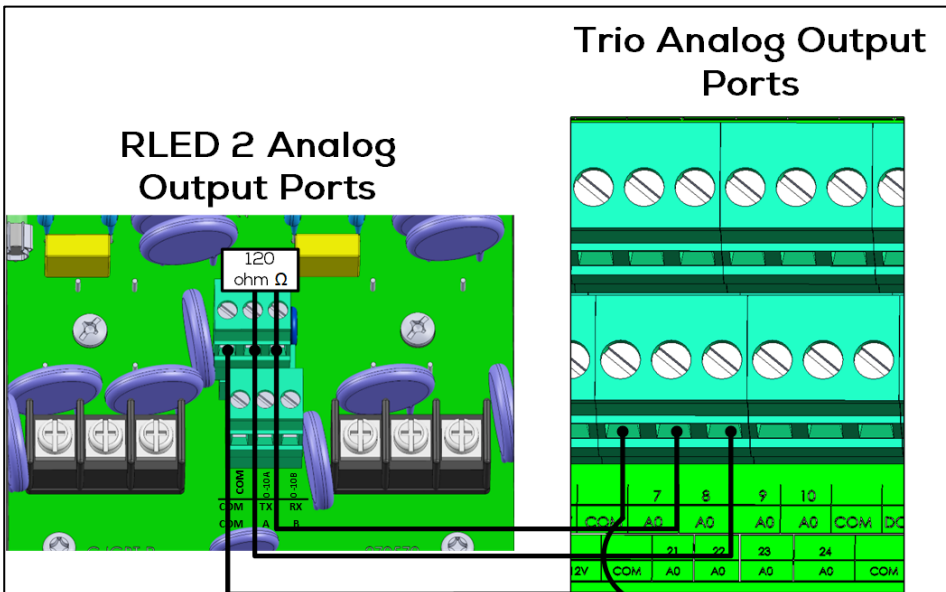

Figure 47: RLED 2 Termination Wiring

3.6 Pressure Sensor Hoses

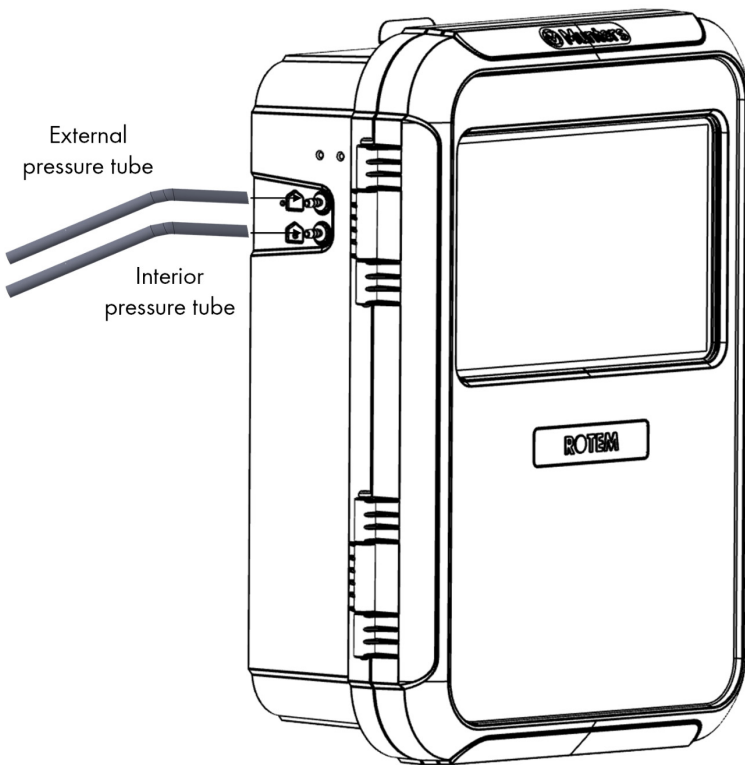

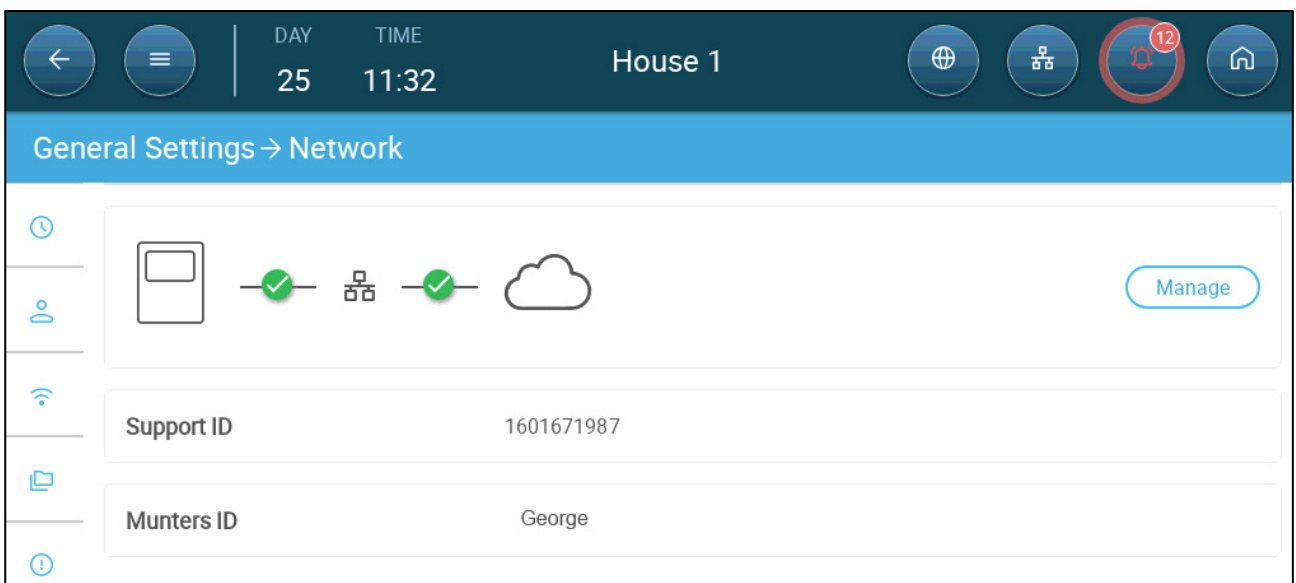

Figure 48: Static pressure hoses

3.7 Tech Support/Wi-Fi

To view your unit's network information go to System > General Settings > Network . You will need this information when speaking with technical support.



- Click Manage.

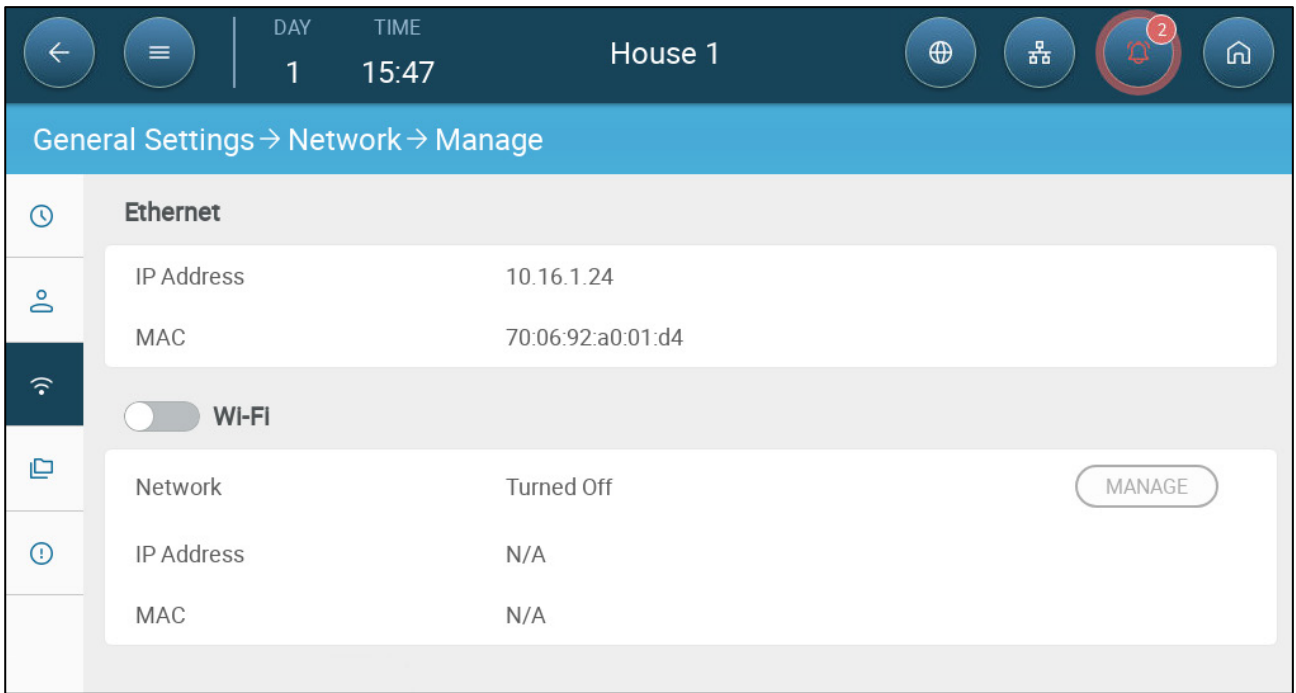

- Ethernet fields are read-only information.
- Enable Wi-Fi if required.

4 TrioAir

TrioAir is the Munters (desktop and cellphone) app that gives users remote access to their controllers. Trio Controllers are connected directly to the internet via a standard modem. Trio Air is the application used to manage your controllers via the web. In addition to seamless access to your Trio Controllers, Trio Air also offers:

- Remote control and configuration
- Centralized dashboard used to easily compare farms and their controllers.
- Real-time alarms and notifications
- Various levels of access control

There are four basic steps in setting up TrioAir.

- Access the App
- Sign Up
- Creating and Managing a Farm
- Adding Controllers to Farms

The following sections give basic information on signing up for Trio Air and adding controllers to the system. For more information, refer to the [Munters Zendesk](#).

4.1 Access the App

The first step in using TrioAir is to access the application, either on your PC or your cellphone.

- [Desktop App](#)
- [Cellphone App](#)

Users wanting to use TrioAir on their computer, go to <https://www.trioair.net>. Alternatively, you can download the app to your smart phone here:

- [Google Play](#)
- [Apple Store](#)

4.2 Sign Up

In using TrioAir, the first step for any user is to create an account. Once this is done, you can be invited to join farms or create your own farms. The creation process is fairly standard and should be familiar for anyone who has ever created an account for any application.

Note: Munters recommends using Google Chrome.

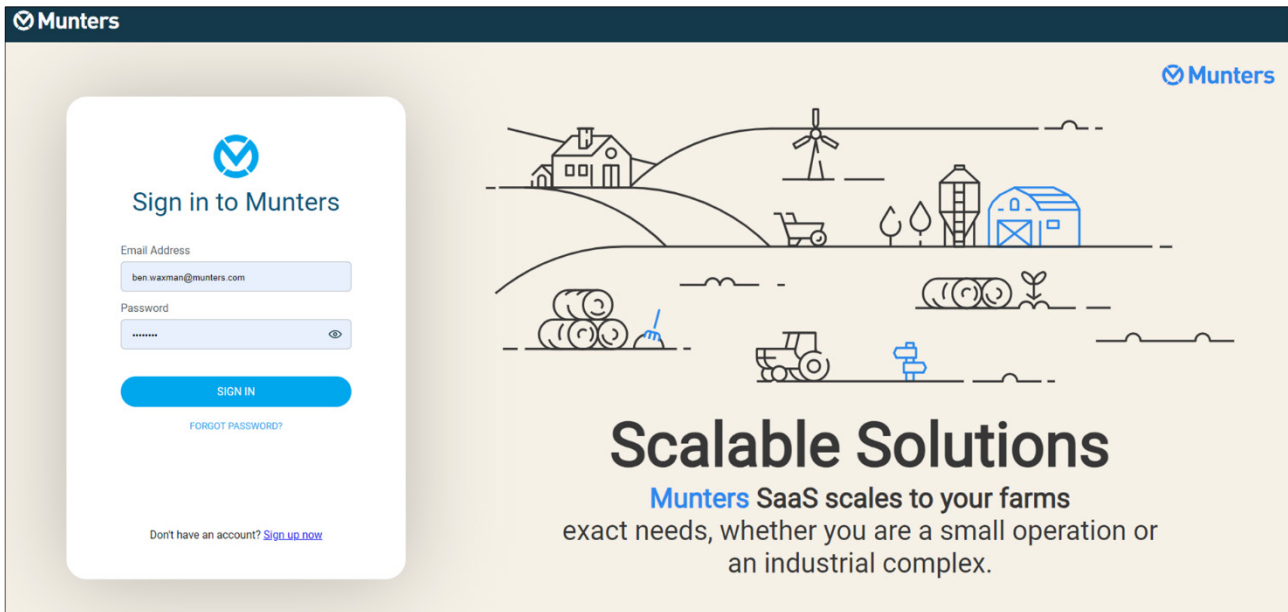

1. Click Sign up now.
2. Enter an email address.
3. Follow the online instructions.
4. Once these steps are completed, an account is created.

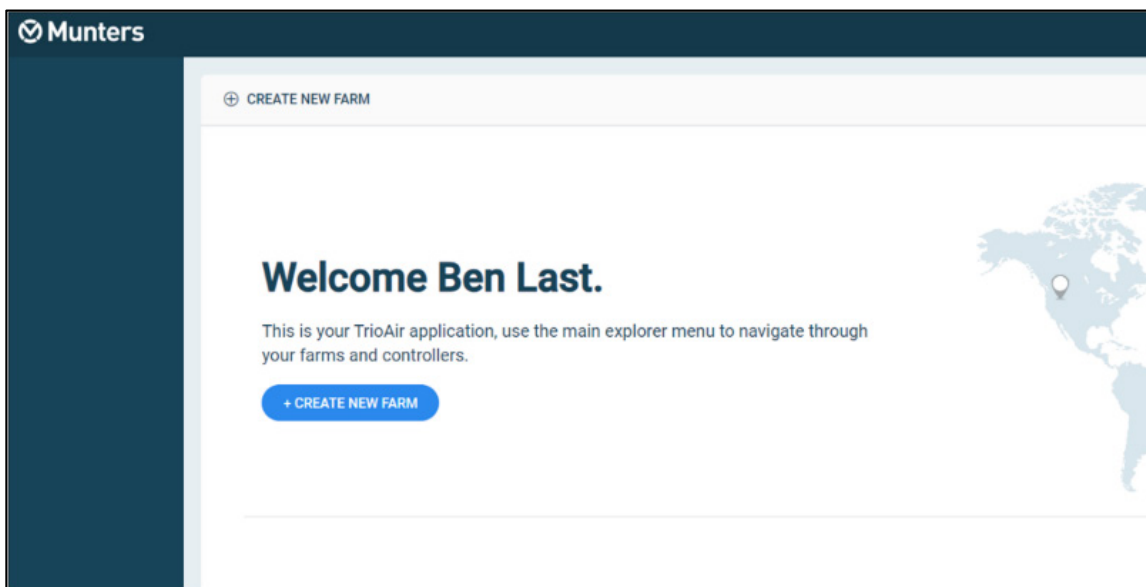

4.3 Adding a Controller to a Farm During Installation

NOTE The following procedure requires that the Trio be connected to the internet. If the unit is offline, refer to Offline Registration.

The first time that a user power ups a Trio, the following Welcome Screen appears.

Welcome To Trio Controller!



Before using your Trio, please register the controller with TrioAir.

Registration enables access to the following features:



Remote Access

Monitor and control your farm remotely and in real-time.



Manage Data

Access your farm data.



Data Insights

Receive data-driven insights needed to make informed decisions.



Remote Control

TrioAir enables remote control over your controllers in multiple manners.

SKIP FOR NOW

GET STARTED

1. Click Get Started. (If you do not want to register the unit at this time, click Skip For Now). The following screen appears.



TrioAir Registration



P2M58L796

To begin the registration process, follow the instructions below.

Note: You must have a TrioAir account to start this process.

1. On your smartphone or desktop, log into TrioAir.

2. Using a smartphone: Scan the QR code. -Or- Using a desktop: Go to Farm Settings > Add New Device. Enter the code manually.

3. Follow the on-line instructions.

2. Follow the instructions on the page. You will need to:

- Select the farm (if there is more than one) to which this Trio is to be added
- Agree to the Terms of Use.

NOTE For more details on the on-line registration process, click [here](#).

NOTE If you do not want to register the unit at this time click **Skip For Now**. The Trio Dashboard shows that the unit is not registered. Click that message to register the Trio.

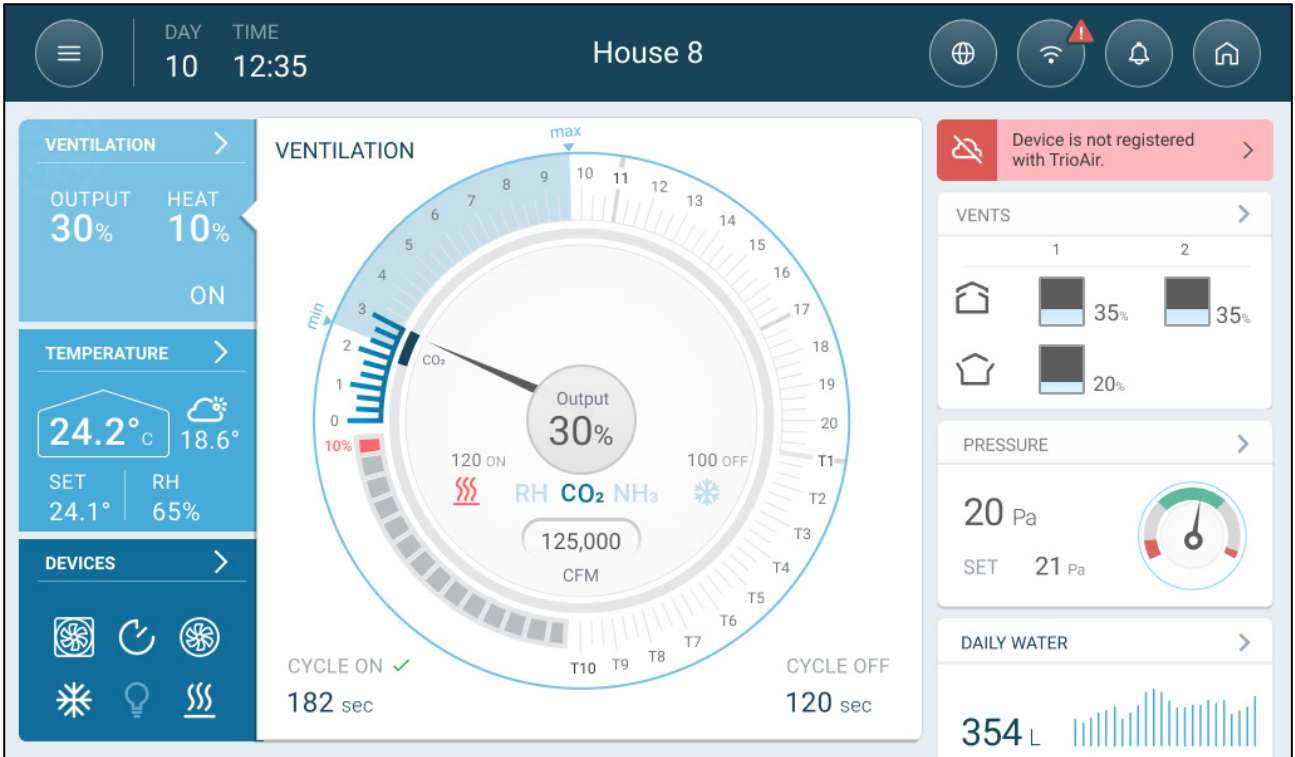

4.4 Offline Registration

If the Trio unit is off-line, that status appears on the registration screen.

Welcome To Trio Controller!

Before using your Trio, please register the controller with TrioAir.

Registration enables access to the following features:

- Remote Access:** Monitor and control your farm remotely and in real-time.
- Manage Data:** Access your farm data.
- Data Insights:** Receive data-driven insights needed to make informed decisions.
- Remote Control:** TrioAir enables remote control over your controllers in multiple manners.

Your device is not connected to the internet. Please connect your device or click Manage Network.

SKIP FOR NOW | **MANAGE NETWORK** | **OFFLINE REGISTRATION**

1. Click Offline Registration. The following screen appears.

← TrioAir Offline Registration



P2M58L796

To begin the registration process, follow the instructions below.
Note: You must have a TrioAir account to start this process.

1. On your smartphone or desktop, log into TrioAir.
2. Using a smartphone: Scan the QR code. -Or- Using a desktop: Go to Farm Settings > Add New Device. Enter the code manually.
3. Follow the on-line instructions.

SKIP FOR NOW CONTINUE





2. Click Continue. Follow the online instructions.

NOTE For more details on how to register the Trio while offline, click [here](#).

5 Specifications

- Trio Specifications
- External Device Specifications

5.1 Trio Specifications

Description	Specification
Input Power Voltage	<ul style="list-style-type: none"> • 100 – 240 VAC • 50/60 Hz
Input AC Power	0.75A (at full load (meaning Wi-Fi, internet, cell phone and 20 relays ON))
Relays	1 Amp. Up to 60% of the relays can operate at any given time.
<i>Note: Running relays at the above current levels provides between 50,000 – 100,000 switching operations.</i>	
Analog Inputs	0 – 3.3 Volts
Analog Output	0 - 10 Volts; maximum load: 20 mA
Digital Inputs	3.3 Volts, 1.5 mA, dry contact
Communication	<ul style="list-style-type: none"> • LAN – Standard 10/100 BaseT • Expansion – RS-485: 115 Kbps, 8 bit, even parity <p><i>NOTE Refer to Appendix F: Ethernet Requirements, page 180 for more information.</i></p>
Operating and Storage Temperature Range	-10° to +50° C (+14° to +125° F)
Environmental Specifications	<ul style="list-style-type: none"> • Altitude: -400 m to 2000 m • Relative Humidity: 20% - 70% • Main supply voltage fluctuation up to 5% • Overvoltage category II
Enclosure	<ul style="list-style-type: none"> • Water and dust tight • Indoor use only
Dimensions (H/W/D)	403 x 324 x 141 mm/16 x 13 x 5.6 inches
Fuses	Fuse F2 & F4 on PS card: 3.15A, 250V
Certification	   

- **Disconnection device/overcurrent protection:** In the building installation, use a certified 2-pole circuit breaker rated 10A, certified in accordance with the IEC standard 60947-2 (in the US and Canada use a Listed Branch Circuit protective circuit breaker). This step is required to provide overcurrent protection and mains

disconnection. The circuit breaker must be easily accessible and marked as the controller disconnect device.

- **Main Supply Voltage:** Permanently connect the controller to the mains in accordance with the relevant national code. Provide fixed wiring inside a flexible conduit. Relays must be suitably protected against overcurrent, using a circuit breaker rated at 10A.
- **Keep the controller closed and locked (refer to Locking the Trio, page 10).** Only authorized personnel should open and close the unit.

5.2 External Device Specifications

Table 1: Summary

I/O type	Qty
Analogue Output	8
Analogue Input	6
Digital Input	8
Temperature Sensors	12 maximum (6 dedicated, 6 optional)
Total	34

Table 2: Output Devices

Device type	Maximum Number of Devices	Number of Relay Devices	Number of Analog Devices
Cooling	2	2	N/A
Heaters	6	6	6
High Heaters	6	6	6
Inlets	4	4	4
Outlets	1	N/A	1
Tunnel Doors/Curtains	4	4	4
Fans Exhaust/Tunnel	20	20	8
Stir Fan	2	2	2
Lights	4	4	4
Timer	5	5	N/A
Auger	2	2	N/A
Feeder	4	4	N/A
As Relay	20	20	N/A
As Analog Out	8	NA	8
Alarm	1	1	N/A

Table 3: Sensors











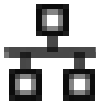

Device type	Analog Sensors	Digital Sensors
Temperature Sensors	12	N/A
Humidity Sensors	2	N/A
Outside Humidity Sensor	1	N/A
CO2 Sensors	1	N/A
Ammonia Sensors	1	N/A
Pressure Sensors	1	N/A
Potentiometers	4	N/A
Bird Weighing	4	N/A
Silo Weighing	3	N/A
Feed Weighing	1	N/A
Lux Meter (light intensity)	1	N/A
Water Meters	N/A	4
Gas Meters	N/A	3
Power Meter	N/A	2
Auxiliary Input	N/A	4
Auger Sensor	N/A	2
Feeder Line Sensors	N/A	4
Feed Weighing by Pulse	N/A	2

Table 4: Other Devices

Device type	Number
RSU-2 Remote Scale Unit	2
RLED Light Dimmer	2

NOTE Refer to Appendix A: External Devices (Previous Versions), page 115 to view details on the input/output capacity of previous versions.

6 Using the Trio Touch Screen

	
	Go back to the previous screen
	View the Main menus
	Choose language
 	Network settings
	View alarms
	Go back to the main screen
	Settings icon
	Edit parameters
	Function settings
	Function test
	Replace the dashboard battery with a standard 3V battery.
	Click this icon to delete data stored on that page.

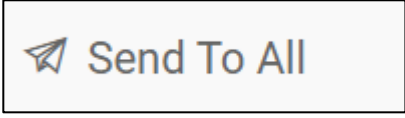
Phone App	
	<p>Click the circle containing the user name to edit personal preferences such as the language, units, name, and more.</p>
	<p>When a Trio controls two or more rooms or there are two or more houses on a farm, Send to All enables editing certain select functions in more than one room or house. Edit the setting, click Send to All, and select the required Trios. The select rooms' or houses' settings are updated. Note: Send to All does not appear on every screen.</p>

7 Mapping and Defining the Input Output Devices

NOTE Munters recommends that a trained technician perform the following operations.

- Using the Mapping Screen
- Mapping Sensors
- Mapping Devices
- Mapping the Weighing Devices
- Trio RPS
- Testing Devices

7.1 Using the Mapping Screen

After wiring devices to the Trio, each device must be mapped and then defined. Mapping and defining devices enables the system software to control each device's functionality.

CAUTION Mapping *MUST* match the physical wiring! An error message appears if the physical device is not wired to the relay or port as defined on the mapping screen.

To map the devices:

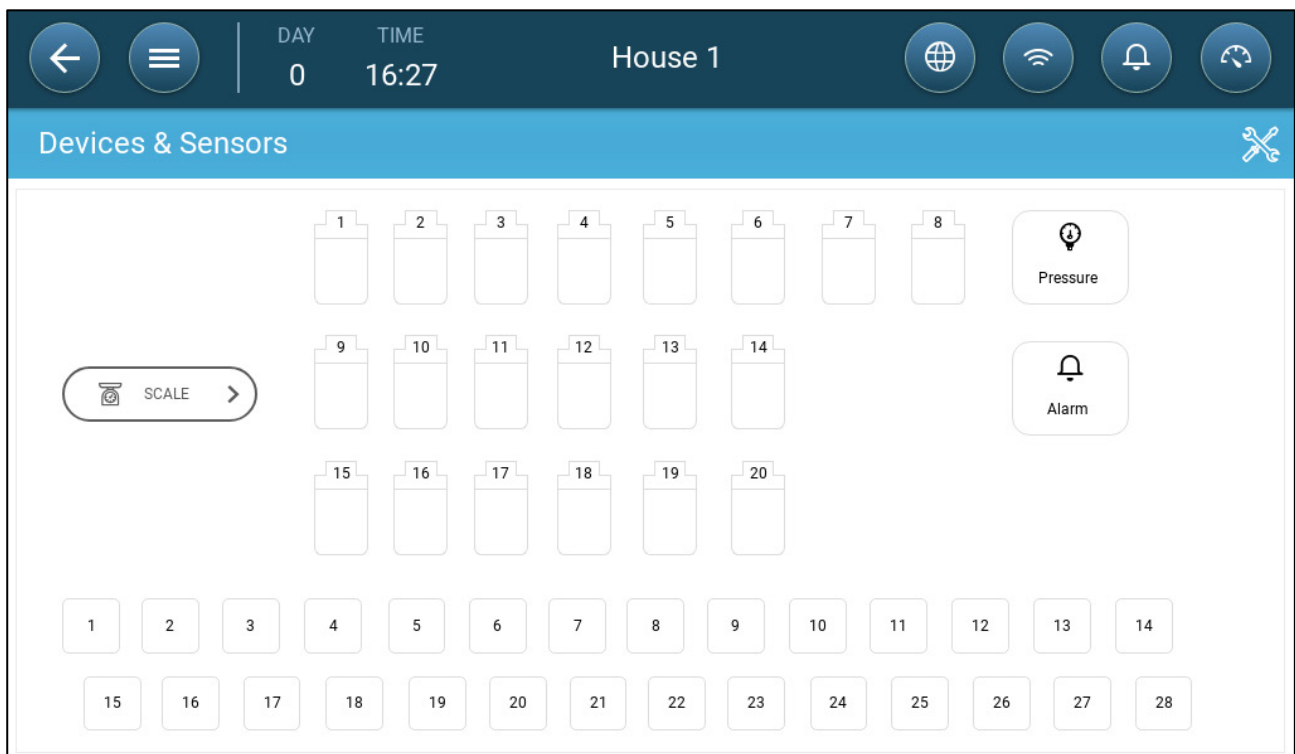

1. Go to System > Device and Sensors.

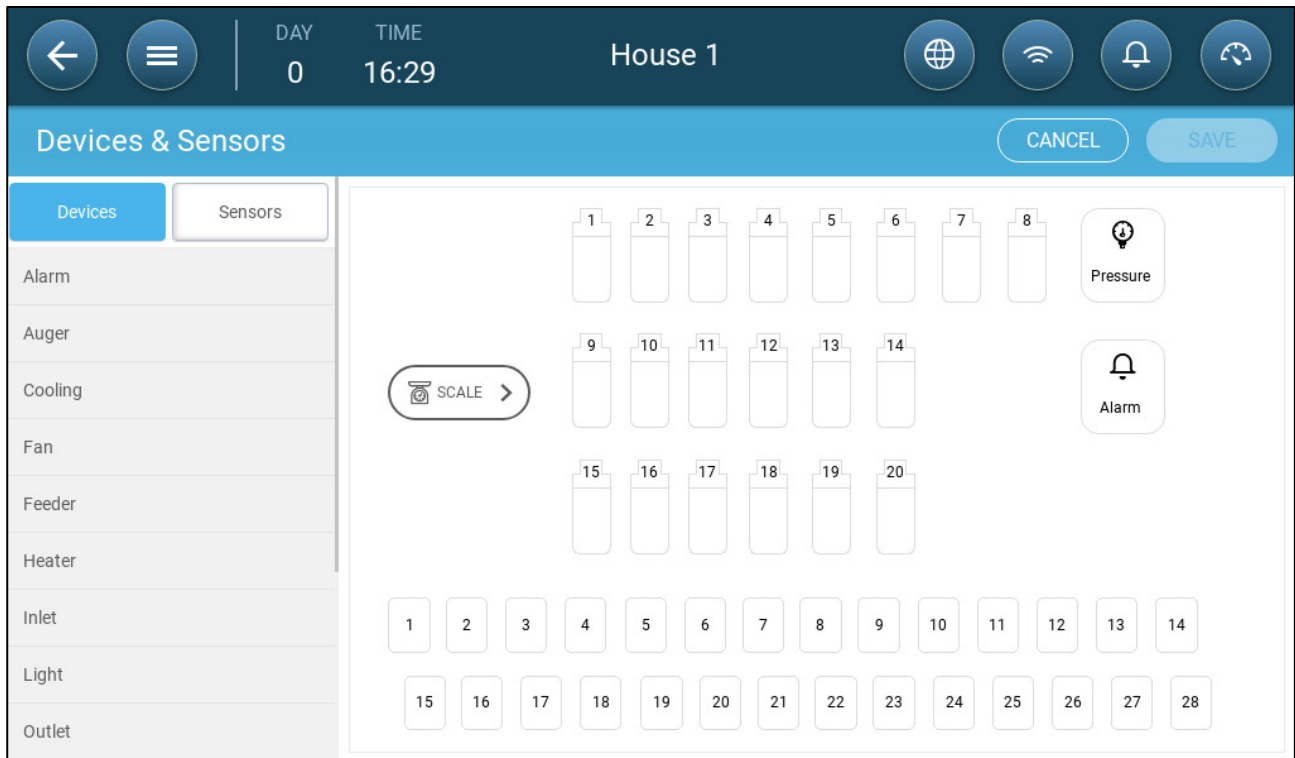

This screen displays the relays and analog/digital ports. At this point all, icons are undefined.

2. Click .



- Click  to map cooling devices, heaters, inlets, fans, stir fans, timers, tunnel doors, outlets, or the alarm relay.
- Click  to map auxiliary inputs, sensors (humidity, pressure, temperature, CO2, ammonia), water meter, and potentiometers.

3. Under Devices or Sensors, click the type of device that you want to map. In the following example, Heater is selected. The screen displays the relays and ports that can be defined as heaters.

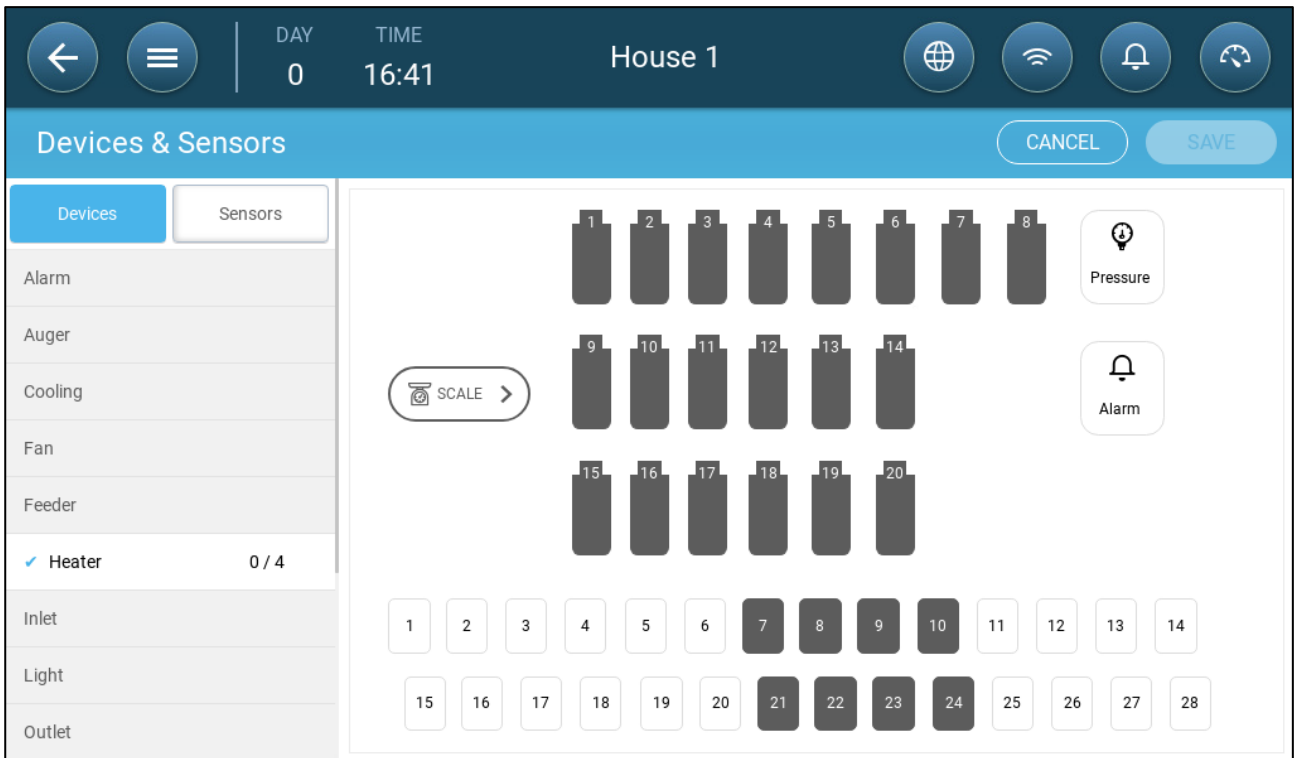

4. Click on the relays and/or ports that you wired to heaters.
 - Trio automatically numbers the devices.
 - Trio enables selecting up to the maximum number of each device.
 - Devices having opening and closing relays require mapping of both relays.
5. Repeat steps 3 and 4 for all the connected devices.

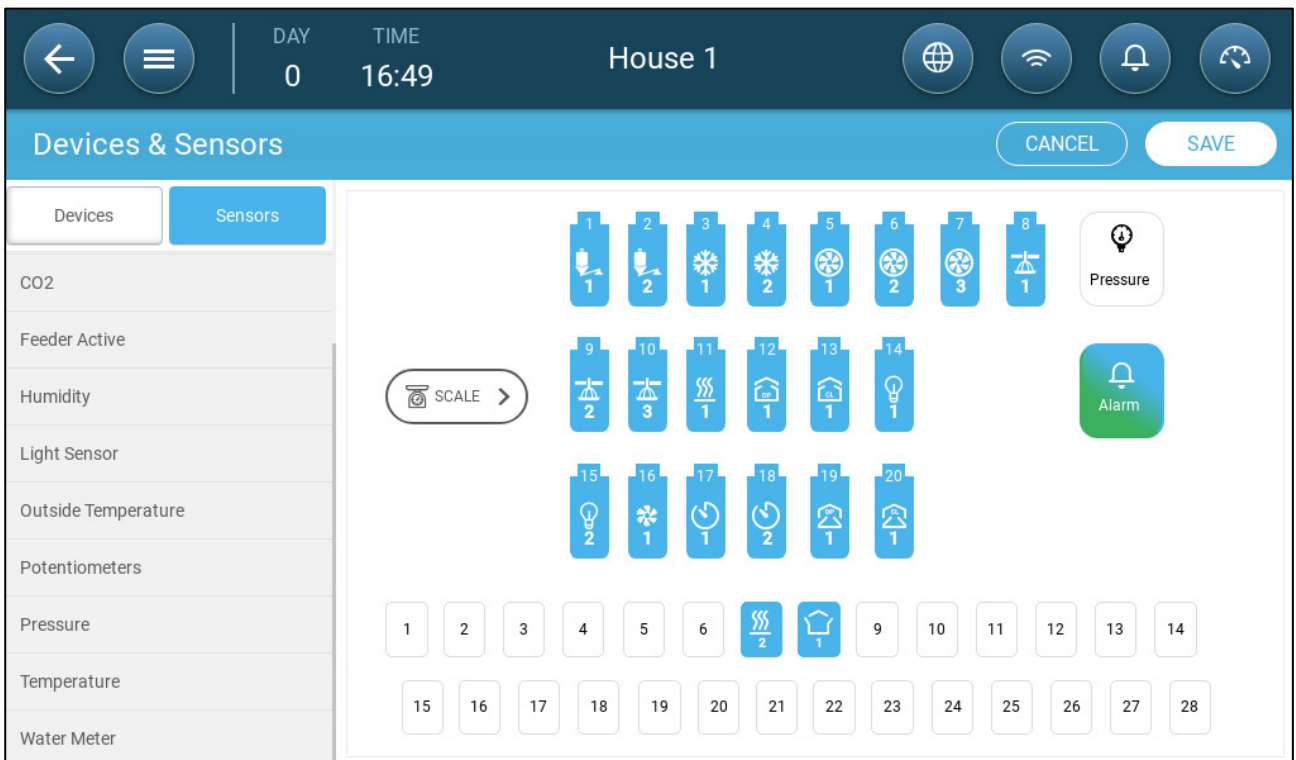

6. After mapping all installed devices, click **SAVE**.

NOTE To un-map a device, click on the required device and hold the icon down.

NOTE If you map a sensor that is not physically connected to the Trio, an error symbol appears on the designated analog port.

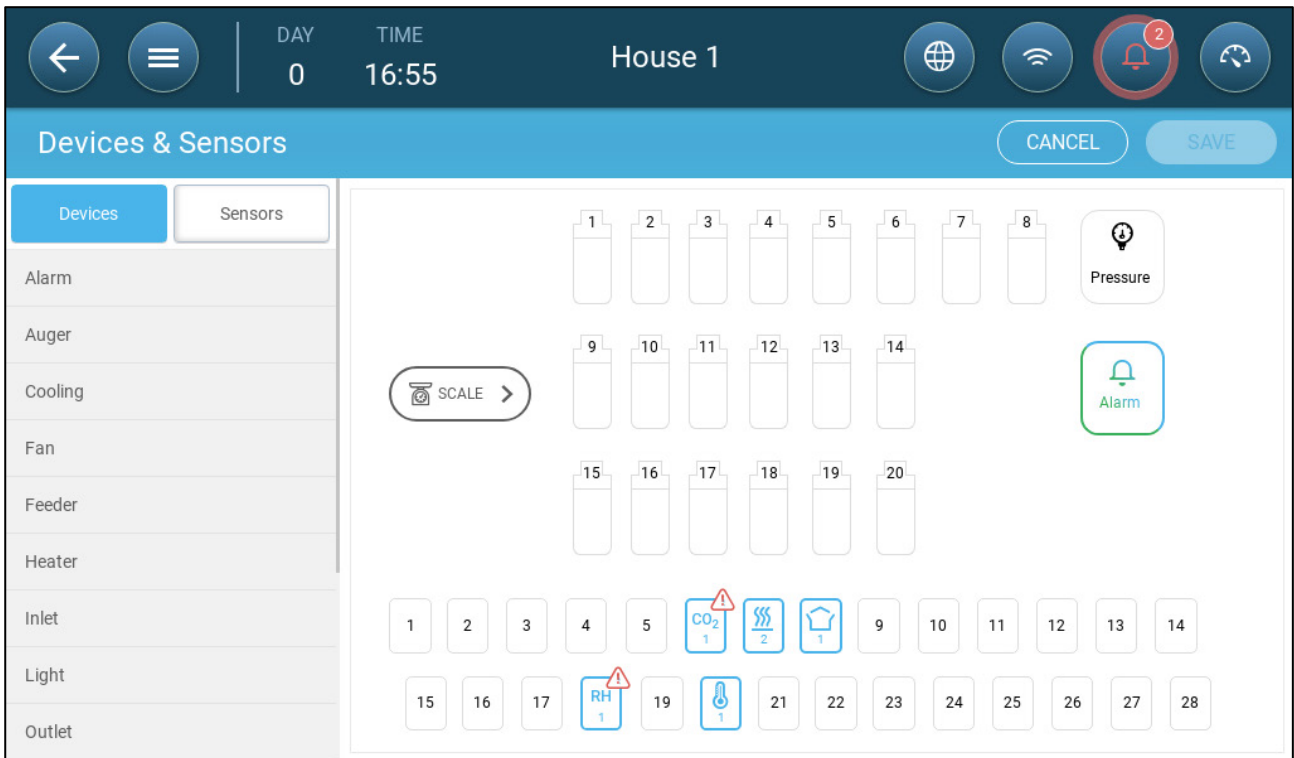

7.2 Mapping Sensors

- Enabling/Disabling Analog Input Sensors
- Temperature Sensors
- Defining the Ammonia Sensor
- Defining the CO2 Sensor
- Defining the Humidity Sensors
- Defining the Water Meter Sensors
- Defining the Gas Meter Sensors
- Defining the Light Sensor
- Defining the Auger Active Sensors
- Defining the Feeder Active Sensors

7.2.1 ENABLING/DISABLING ANALOG INPUT SENSORS

By default, when the user maps an analog input sensor, the sensor is enabled. To disable a sensor:

1. Go to the device and click edit .
2. Move the enable mode icon to off and click Save.

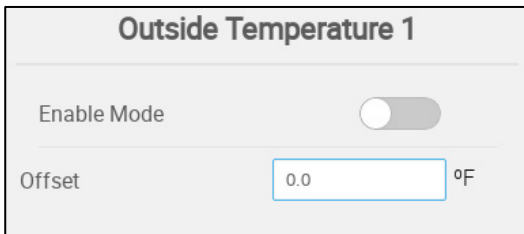

3. On the dashboard, a disabled sensor is marked.

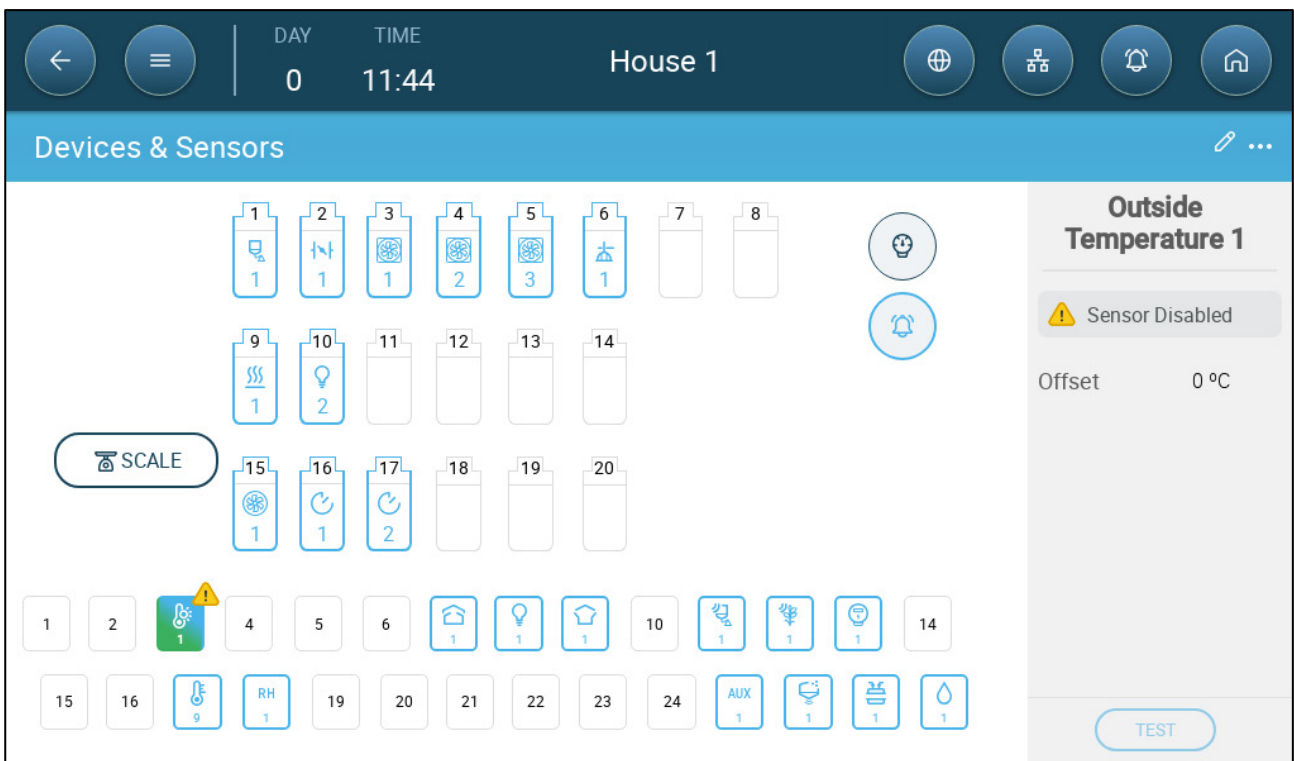

7.2.2 TEMPERATURE SENSORS

- Defining the Temperature Sensors
- Mapping the Temperature Sensors
- Enabling a Weather Station

7.2.2.1 Defining the Temperature Sensors

- Define up to 12 analog input ports as temperature sensors (and one port as an outside temperature sensor).

Temperature 1

Offset	0 °F
Location	Front

TEST

Outside Temperature 1

Offset	0 °F
--------	------

TEST

- Define:
 - Offset: This is an optional correction for the temperature sensor. Range: -10° C to +10° C
 - Enabled: enable/disable the sensor.
 - Location: Designate the area in the room where the sensor is located (front/back/center).
- The temperature reading shows the measured temperature, including the offset.

7.2.2.2 Mapping the Temperature Sensors

Calculating the temperature data, Trio takes the following into consideration:

- Tunnel temperature: Select a sensor or a group of sensors to determine the tunnel temperature readings or select if the tunnel runs according to the average temperature reading.
- Average temperature: Data from multiple sensors can be averaged. If a sensor fails, the sensor's data is removed from any calculations.
- Device temperature: A sensor (or sensors) can be mapped to a specific device.
- Outside temperature: The temperature sensor defined as an outside temperature is not included in any average calculation.

Map specific temperature sensors to specific devices.

- Go to System > Temperature Definition.

Device	Avg.	Temperature Sensors	Outside
Full House		1 3	
Cooling 1	✓		
Timer 1		1	
Timer 2			✓
Timer 3		2	

- Map the sensors to devices.
 - Define which sensors are used to calculate the average temperature.
 - If an outside temperature sensor is enabled, map timers to it (if required).

NOTE Uninstalling a device in the Relay Layout, Analog Output or TRIAC tables removes the device from this screen.

7.2.2.3 Enabling a Weather Station

To save costs on temperature sensors, one outdoor temperature sensor can provide data to the entire Trio network.

NOTE Install and map one outdoor sensor only.

1. In System > Device and Sensors, define one sensor as Outside Temperature.

2. Go to System > Control Strategy > Weather Station .

Control Strategy	Weather Station
Recieve Ouside Temp. Broadcast	Enabled

3. Enable Receive Outside Temp. Broadcast.

7.2.3 DEFINING THE AMMONIA SENSOR

- Define one analog input port as an ammonia sensor (refer to Using the Mapping Screen, page 70).



Ammonia 1

Offset 0

TEST

- Define:
 - Offset: This is an optional correction for the ammonia sensor. Range: -10 to +10 ppm
 - Enable Mode: Enable/disable the sensor.
- The ammonia reading shows the measured amount, including the offset.

7.2.4 DEFINING THE CO2 SENSOR

- Define one analog input port as a CO2 port (refer to Using the Mapping Screen, page 70).

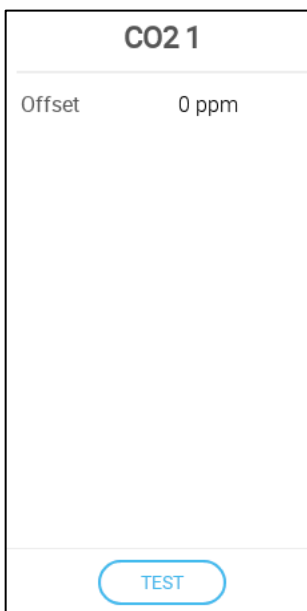

CO2 1

Offset 0 ppm

TEST

- Define:
 - Offset: This is an optional correction for the CO2 sensor. Range: -500 to +500 ppm
 - Enable Mode: Enables/disables the sensor.
- The CO2 reading shows the measured amount, including the offset.

7.2.5 DEFINING THE HUMIDITY SENSORS

➤ Define (refer to Using the Mapping Screen, page 70):

- One or two analog input ports as a humidity sensor
- One analog input port as an outside humidity sensor. The outside humidity is used to collect data, not to adjust climate control.

Humidity 2	
Offset	0

Outside Humidity 1	
Offset	0

- Define:
 - Offset: This is an optional correction for the humidity sensor. Range: -10 to +10%
 - Enable Mode: Enables/disables the sensor.
- The humidity reading shows the measured level, including the offset.

7.2.6 DEFINING THE WATER METER SENSORS

- Define up to four (4) digital input ports as a water meter (refer to Using the Mapping Screen, page 70).

Water Meter 1	
QTY/Pulse	0.3 G
Meter Input	Drinking Water

TEST

- Define:
 - Quan/Pulse: Set the water meter's water flow per pulse. Range: 0.0 to 99.9 (unit depends on the General Settings > User.)
 - Meter input: Chose drinking water or cooling.

7.2.7 DEFINING THE GAS METER SENSORS

- Define up to three digital input ports as a gas meter (refer to Using the Mapping Screen, page 70).

Gas Meter 1	
QTY/Pulse	0.3 G

TEST

- Define:
 - Quan/Pulse: Set the gas meter's flow per pulse. Range: 0.0 to 999 (unit depends on the General Settings > User).

7.2.8 DEFINING THE POWER METER SENSORS

- Define up to two digital input ports as a power meter (refer to Using the Mapping Screen, page 70).

Power Meter 1	
Power Source	Main
Pulses per kW	1

TEST

- Define:
 - Power Source:
 - Main: Power meter measures the amount of electricity used by the system.
 - Heat: Power meter measures the amount of electricity used by the heaters.
 - Pulses kW: Set the number of pulses per kilowatt. Range: 1 to 1000.

7.2.9 DEFINING THE LIGHT SENSOR

- Define one analog ports as a light sensor.(refer to Using the Mapping Screen, page 70)

Light Sensor 1

TEST

- Define:
 - Enable Mode: Enable/disable the sensor.

7.2.10 DEFINING THE AUGER ACTIVE SENSORS

➡ Define up to two digital ports as auger active.

Cross Auger Active 1	
Active State	Open
Quantity Per Minute	0 Kg

- Define:
 - Active state:
 - Open: The circuit is open when the sensor is activated.
 - Closed: The circuit is closed when the sensor is activated .
 - Quantity Per Minute: Define the amount (weight per minute) of feed to be distributed.

7.2.11 DEFINING THE FEEDER ACTIVE SENSORS

➡ Define up to four digital input ports as feeder active.

Feeder Active 1	
Active State	Open

- Define
 - Active State: Select if the relay is normally open or normally close.
 - Open: The circuit is open when the sensor is activated.
 - Closed: The circuit is closed when the sensor is activated.

7.3 Mapping Devices

- Defining the Fans
- Defining the Stir Fan
- Heating Devices
- Defining the Cooling Devices
- Potentiometers, Inlets, Tunnel Doors, Outlets

- Defining the Same As Relays
- Defining the Same As Analog Ports
- Defining the Timers
- Defining the Auxiliary Input
- Lighting Devices
- Feeding Devices
- Fail Safe Devices

7.3.1 DEFINING THE FANS

The following sections detail how to configure fans.

NOTE These settings should be configured by a technician familiar with the fan and inlet/curtain specifications.

Fan air capacity defines how much air is provided when the fans run at full speed. These numbers are used to calculate minimum air requirements.

- ➔ In General Settings > User define the measurement unit.
- ➔ Define up to 20 relays or analog output ports as On/Off or 0 – 10 V fans, respectively (refer to Using the Mapping Screen, page 70).
 - On-Off Fans
 - 0 – 10 Volt Fans

7.3.1.1 On-Off Fans

Fan 1

Capacity 0 M3/h

KWh 0

Reverse Relay Output

TEST

- Define:
 - Capacity: Enter the fan capacity.
 - KWh: This field displays the amount of kilowatts used. Read-only.
 - Reverse Relay Output: Select if the relay is normally open or normally close.

7.3.1.2 0 – 10 Volt Fans

Fan 3	
Min. Voltage (V)	0.0
Max. Voltage (V)	10.0
Min. Capacity	1,000 M3/h
Max. Capacity	5,000 M3/h
KWh	0.0
Boost Time (sec.)	5

 0.0

- Define:
 - Minimum/Maximum Voltage: Enter the minimal and maximal voltage used to calibrate the fan speed. For example, if the minimum voltage is set to 2V and the maximum to 8V the controller applies the calculated 0-100% output over a 2V-8V signal.
 - Minimum/Maximum Capacity: Enter the fan's minimum and maximum capacity. These numbers are used to calculate the curve between these points.
 - KWh: This field displays the amount of kilowatts used. Read-only.
 - Boost Time: During this amount of time, the controller applies full power to the fan motor (100%). Boosting the speed is done to open shutters or extend the motor life. In addition, some types of motors have a minimum starting speed.

7.3.2 DEFINING THE STIR FAN

- Define up to two relays or ports as a stir fan (refer to Using the Mapping Screen, page 70).
 - On Off Stir Fan
 - 0 – 10 Volt Stir Fan

7.3.2.1 On Off Stir Fan

Stir Fan 1	
KWh	0
Reverse Relay Output	<input type="checkbox"/>

- Define:
 - KWh: This field displays the amount of kilowatts used. Read-only
 - Reverse Relay Output: Select if the relay is normally open or normally close.

7.3.2.2 0 – 10 Volt Stir Fan

Stir Fan 1

Min. Voltage (V) 0

Max. Voltage (V) 10

KWh 0

TEST

- Define:
 - Minimum/Maximum Voltage: Enter the minimal and maximal voltage used to calibrate the fan speed. For example, if the minimum voltage is set to 2V and the maximum to 8V the controller applies the calculated 0-100% output over a 2V-8V signal.
 - KWh: This field displays the amount of kilowatts used. Read-only.

7.3.3 HEATING DEVICES

- Define up to six relays and/or analogue output ports as heaters (refer to Using the Mapping Screen, page 70).
 - Defining the On/Off Heaters
 - Defining the Variable Heaters
 - Defining the High Heaters

7.3.3.1 Defining the On/Off Heaters

Heater 2

KWh 0

Reverse Relay Output

Ignition Time (sec.) 0

TEST

- Define:
 - KWh: This field displays the amount of kilowatts used. Read-only
 - Reverse Relay Output: Enable this function for Normally Closed Relays.
 - Ignition Time (sec.): Define the delay time between when the heater is turned on and when the gas is ignited.
 - Test checks the relay functionality.

7.3.3.2 Defining the Variable Heaters

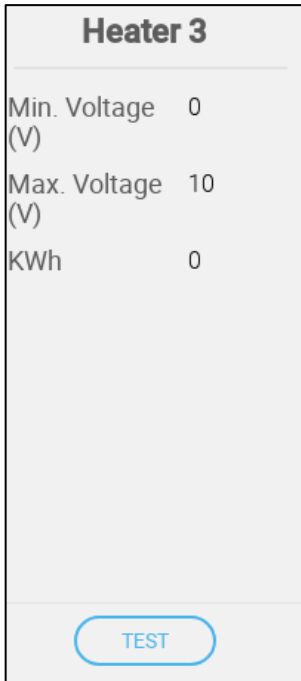

Heater 3

Min. Voltage (V) 0

Max. Voltage (V) 10

KWh 0

TEST

- Define:
 - Min./Max Voltage: Define the voltage in the analogue output port that corresponds to the 0% and 100% output, respectively. For example, if the minimum voltage is set to 2V and the maximum to 8V the controller applies the calculated 0-100% output over a 2V-8V signal.
 - KWh: This field displays the amount of kilowatts used. Read-only.

7.3.3.3 Defining the High Heaters

High heaters work in conjunction with relay heaters. High heater 1 works with heater 1, high heater 3 works with heater 3, and so on. If there is no corresponding heater to a high heater, the latter does not function. For example, if there are three heaters and four high heaters, high heater 4 does not function.

➡ Define up to six relays as high heaters (refer to Using the Mapping Screen, page 70).



Heat High 1

Reverse Relay Output

TEST

- Define:
 - Reverse Relay Output: Enable this function for Normally Closed Relays.

7.3.4 DEFINING THE COOLING DEVICES

- Define up to two relays as cooling devices (refer to Using the Mapping Screen, page 70).

Cooling 1

KWh 0

Reverse Relay Output

TEST

- Define:
 - KWh: This field displays the amount of kilowatts used. Read-only.
 - Reverse Relay Output: Enable this function for Normally Closed Relays.

7.3.5 POTENTIOMETERS, INLETS, TUNNEL DOORS, OUTLETS

- Mapping the Potentiometers
- Defining the Inlets/Tunnel Doors
- Defining the Outlet

7.3.5.1 Mapping the Potentiometers

- Define up to four analogue ports as potentiometers (refer to Using the Mapping Screen, page 70).

As an option, potentiometers enable exact positioning of relay-controlled inlets\tunnel doors when calibrating. If:

- potentiometers are not employed or
- there is a potentiometer failure

opening and closing times are used to calibrate the inlets/tunnel doors.

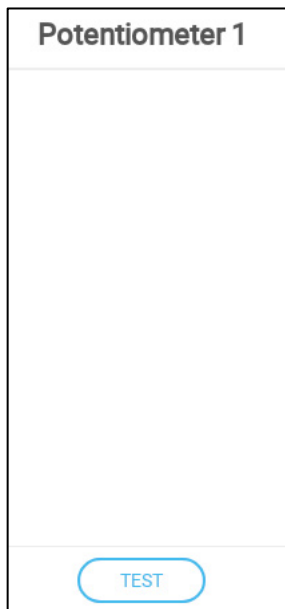

- Enable/disable the potentiometer.

7.3.5.2 Defining the Inlets/Tunnel Doors

- Define up to four relays or analog output ports as inlets or tunnel doors (each device requires two relays or one analogue port) (refer to Using the Mapping Screen, page 70).

Inlet 2	
Position	By Time
Open Time (sec.)	60
Close Time (sec.)	60
Open Reverse Relay Output	<input type="checkbox"/>
Close Reverse Relay Output	<input type="checkbox"/>
<input type="button" value="TEST"/>	

Tunnel Door 1	
Min. Voltage (V)	0
Max. Voltage (V)	10
Open Time (sec.)	60
Close Time (sec.)	60
<input type="button" value="TEST"/>	

- For relay-controllers devices, define:
 - Position: Define how the inlet opening is controlled:
 - By time
 - Potentiometer (relay-controlled inlets or tunnel doors only). Map each inlet/tunnel door to a potentiometer. This option appears only if potentiometers are mapped.
 - Open/Close Time: Measure and enter the amount of time required to fully open or fully close the inlet. These parameters are only enabled when Position/By Time is selected.
 - Open/Close Reverse Relay Output: Enable this function for Normally Closed Relays.
 - Calibrate: Manually calibrate inlets/tunnel doors positioned by a potentiometer. Potentiometer-controlled calibration only.
- For 0 – 10V controlled devices, define:
 - Min./Max Voltage: Define the voltage in the analogue output port that corresponds to the 0% and 100% output, respectively.
 - Open/Close Time: Measure and enter the amount of time required to fully open or fully close the inlet.

7.3.5.2.1 Potentiometer Calibration

If used, a potentiometer can control the opening and closing with a high degree of precision. When there is no potentiometer, positioning accuracy tends to degrade after the inlets go through several opening and closing cycles.

In order to calibrate an inlet/vent/tunnel door using a potentiometer (refer Potentiometers, Inlets, Tunnel Doors, Outlets, page 87 for details):

- Install and map a potentiometer.
- Define the relay-controlled inlet/vent/tunnel door that the potentiometer controls. (Analog controlled devices don't require a potentiometer.)
- Calibrate the potentiometer. Calibration must be successful.

In for any reason potentiometer calibration does not function:

- calibration is by time (auto and/or at power up). Time calibration does not fail.
- A potentiometer alarm is generated (if alarms are enabled) . The alarm must be reset to enable potentiometer calibration to function.

7.3.5.2.2 Calibrating the Inlets/Tunnel Door

During installation, the user enables auto-calibration or power up calibration in digital output (relay) inlets. Calibration automatically takes place after the number of inlet movements equals the number of movements required to start calibration or at Trio power up.

Only one inlet or tunnel curtain can be calibrated at a time.

- Relay open occurs when the target position is 100%.
- Relay close occurs when the target position is 0%.

1. Go to System > Control Strategy > Ventilation .

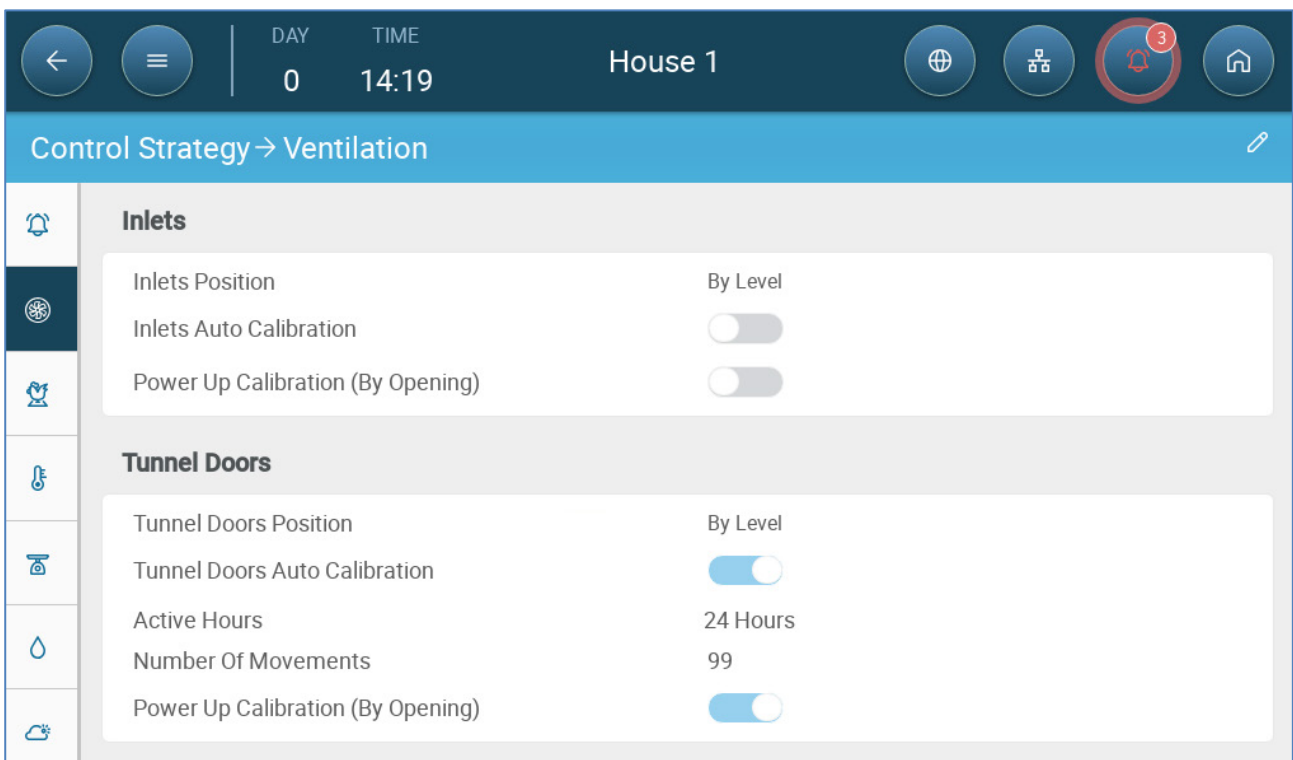

2. Click .

3. Define:

- Inlets/Tunnel Position: Refer to the User Manual.
- Auto Calibration: If enabled, the inlet or tunnel automatically recalibrates itself.

- Select 24 hours a day or define a specific time frame.
- Number of Movements: Define up the number of steps (number of movements) after which the inlet/tunnel door automatically calibrates.
 - Power Up Calibration: Enable this function to have the inlet/tunnel recalibrate itself each time power is applied.
- Potentiometer-controlled calibration failure: If calibration fails (during auto or power up calibration) in a potentiometer-controlled calibration, an error symbol appears in the Devices and Sensor screen.

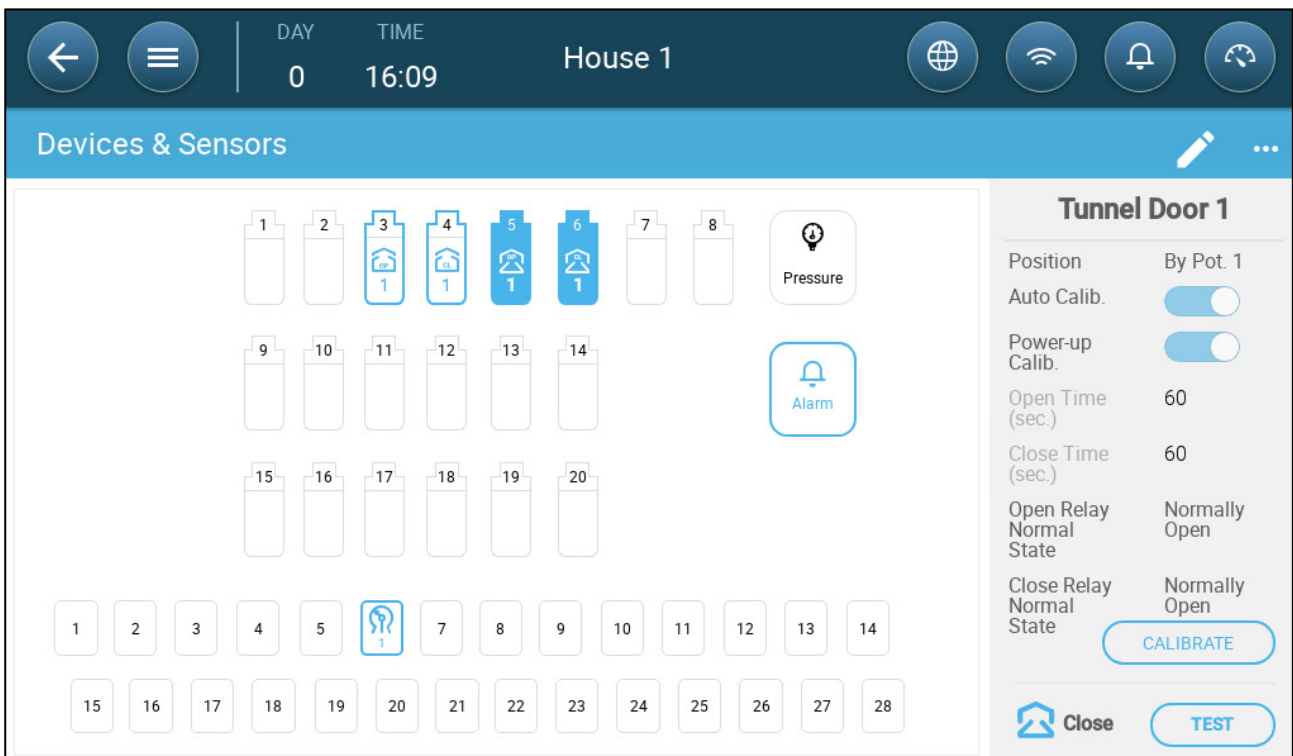

In this situation, click **Calibrate** to run the Calibration Wizard. If the calibration fails again, check:

- Potentiometer wiring
- Potentiometer
- Inlets' and curtains' opening and closing position. There must be a minimum distance between the two, equivalent to 300 A2D points.

7.3.5.3 Defining the Outlet

- Define one analog output port as an outlet (refer to Using the Mapping Screen, page 70).

Outlet 1	
Min. Voltage (V)	0
Max. Voltage (V)	10
Open Time (sec.)	60
Close Time (sec.)	60

TEST

- Define:
 - Min./Max Voltage: Define the voltage in the analogue output port that corresponds to the 0% and 100% output, respectively.
 - Open/Close Time: Enter the amount of time required to fully open or fully close the inlet.

7.3.6 DEFINING THE SAME AS RELAYS

- Define up to 20 relays as Same as Relay (refer to Using the Mapping Screen, page 70).

This function enables defining a relay to operate using the parameters defined for another relay. A relay can be tied to any other relay.

Same As Relay -	
Related Channel	0
KWh	0
Reverse Relay Output	<input type="checkbox"/>

TEST

- Define:
 - Related: Define which relay number to follow. Range: 1 – 20
 - KWh: This field displays the amount of kilowatts used. Read-only.
 - Reverse Relay Output: Select if the relay is normally open or normally close.

7.3.7 DEFINING THE SAME AS ANALOG PORTS

- Define up to eight relays as Same as Analog Ports (refer to Using the Mapping Screen, page 70).

This function enables defining a relay to operate using the parameters defined for a corresponding analog port. Relays can be mapped to eight specific ports only.

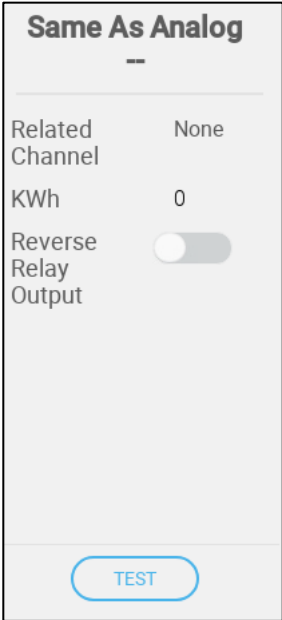
	<ul style="list-style-type: none"> • Define: <ul style="list-style-type: none"> ○ Related Channel: Define which port number to follow. ○ KWh: This field displays the amount of kilowatts used. Read-only. ○ Reverse Relay Output: Select if the relay is normally open or normally close.
--	---

Port Number	Related Channel
7	1
8	2
9	3
10	4
21	5
22	6
23	7
24	8

7.3.8 DEFINING THE TIMERS

➡ Define up to five relays as timers (refer to Using the Mapping Screen, page 70).

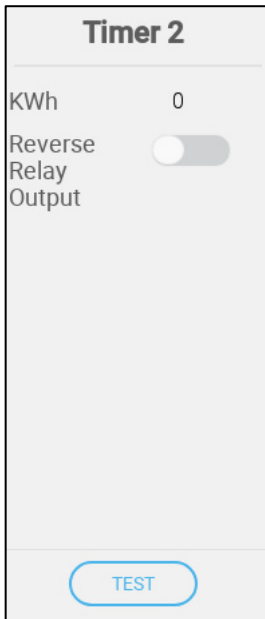

- Define:
 - KWh: This field displays the amount of kilowatts used. Read-only.
 - Reverse Relay Output: Select if the relay is normally open or normally close.

7.3.9 DEFINING THE AUXILIARY INPUT

➡ Define up to four digital inputs as auxiliary inputs (refer to Using the Mapping Screen, page 70).

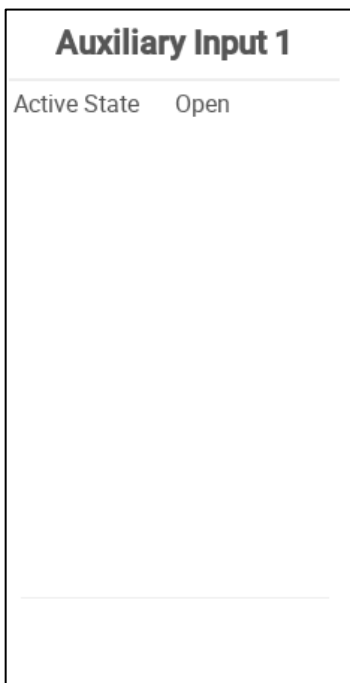

- Define:
 - Operation: Define the relay mode.

7.3.10 LIGHTING DEVICES

➤ Define up to four relays or analog ports as light relays and one sensor as a light sensor (refer to Using the Mapping Screen, page 70). In addition, Version 8.3.X supports the RLED 2.0 Light Dimmer.

- Defining the On/Off Lights
- Defining the Variable Lights
- Defining the RLED 2.0

7.3.10.1 Defining the On/Off LIGHTS

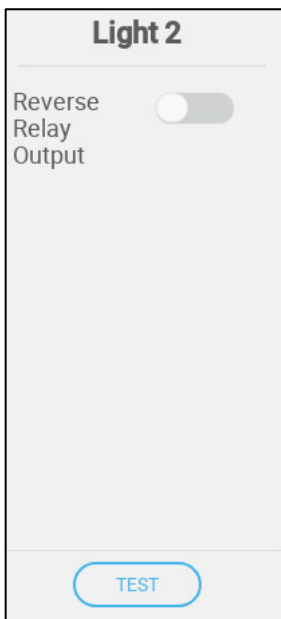

- Define:
 - Reverse Relay Output: Select if the relay is normally open or normally close.

7.3.10.2 Defining the Variable LIGHTS

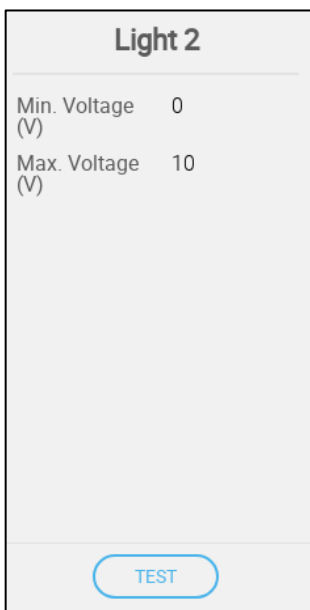

- Define:
 - Minimum/Maximum Voltage: Enter the minimal and maximal voltage used to calibrate the fan speed. For example, if the minimum voltage is set to 2V and the maximum to 8V the controller applies the calculated 0-100% output over a 2V-8V signal.

7.3.10.3 Defining the RLED 2.0

➤ The RLED icon does not appear unless an RLED 2.0 is connected to a Trio.

1. Go to Devices & Sensors.

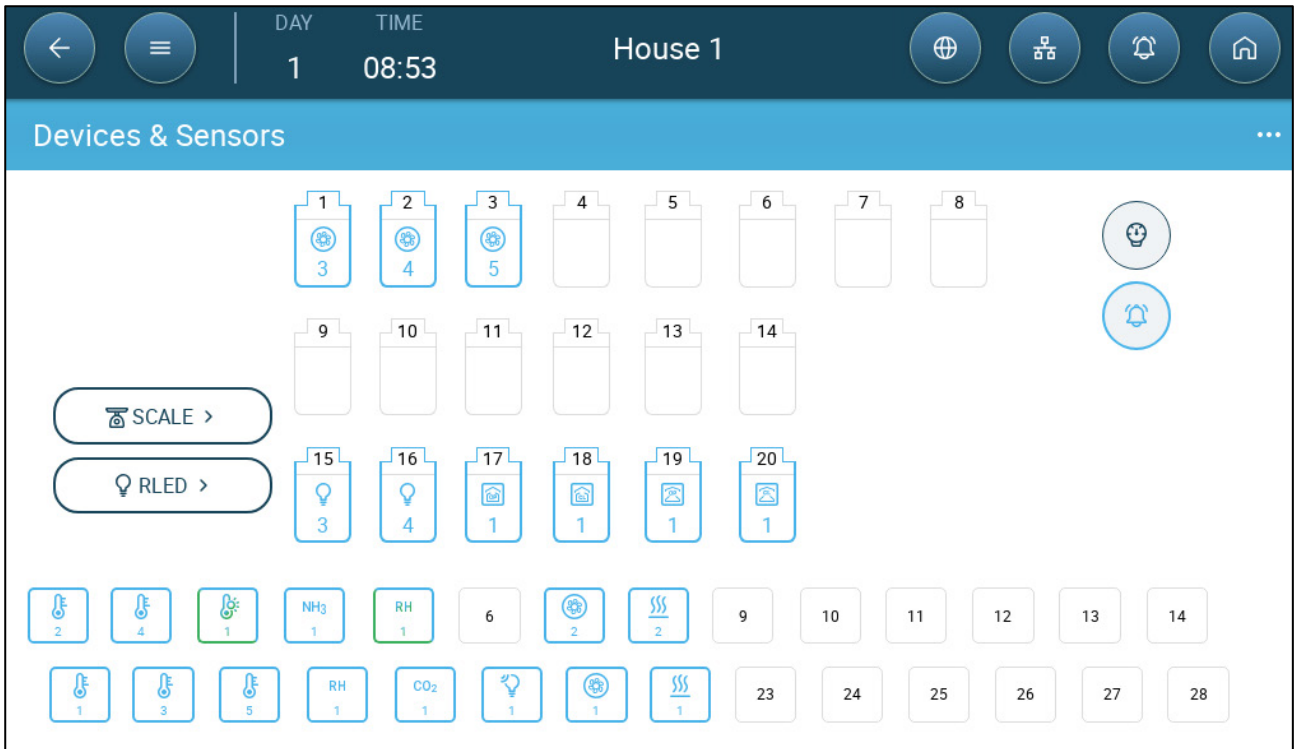

2. Click RLED.

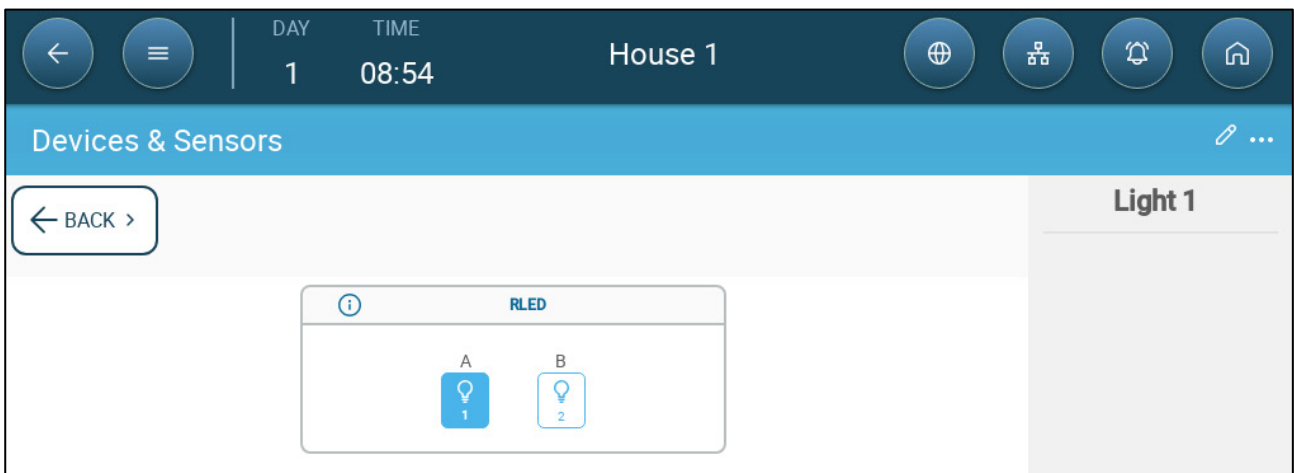

3. Select one RLED 2.0 channel.

4. Select the relays or ports. The RLED 2.0 will control those lights.

7.3.11 FEEDING DEVICES

Setting up a feed system requires auger relays and sensors, and feeder relays and sensors. Define:

- Auger and feed relays to control the auger/feeder lines.
- Auger digital sensors to detect auger overtime issues: silo is empty, feed lines are stuck, or other mechanical issue.
 - Auger 1 is automatically associated with Augur Active Sensor 1. Auger 2 is automatically associated with Augur Active Sensor 2.
 - Feeder 1 active is associated to feeder 1 relay, feeder 2 active to feeder 2 relay, etc.
- Defining the Auger Relays
- Defining the Feeder Relays

7.3.11.1 Defining the Auger Relays

➡ Define up to two relays as augers.

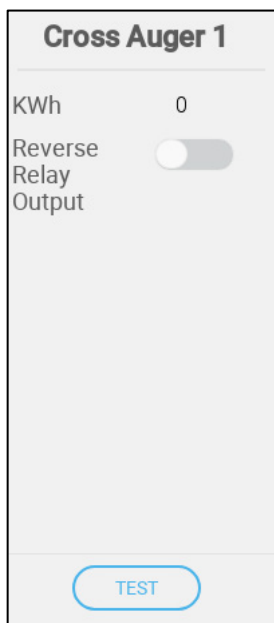

Cross Auger 1

KWh 0

Reverse Relay Output

TEST

- Define:
 - KWh: This field displays the amount of kilowatts used. Read-only.
 - Reverse Relay Output: Select if the relay is normally open or normally close.

7.3.11.2 Defining the Feeder Relays

➡ Define up to four relays as feeders (refer to Using the Mapping Screen, page 70).

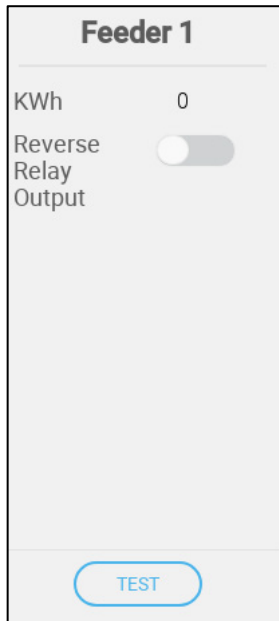

- Define:
 - KWh: This field displays the amount of kilowatts used. Read-only.
 - Reverse Relay Output: Select if the relay is normally open or normally close.

7.3.12 FAIL SAFE DEVICES

The Fail Safe function defines extreme conditions that activate dedicated failsafe relays. These relays activate external devices used to deal with the condition.

➡ Define up to four relays as fail safe relays.

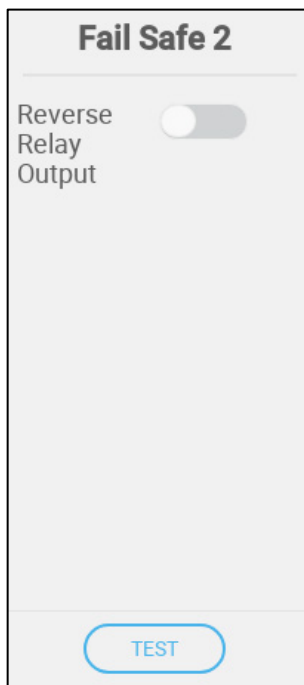

- Define:
 - Reverse Relay Output: Define the relay mode as Closed.

7.4 Mapping the Weighing Devices

- Defining the Silos
- Defining BinTrac Silos
- Defining the Bird Scales
- Defining the RSU

7.4.1 DEFINING THE SILOS

- Mapping the Silo Scales
- Configuring the Silo Scale
- Testing the Silo

7.4.1.1 Mapping the Silo Scales

Trio can support up to three silo scales.

➔ This function requires a scale card.

1. On the Devices & Sensors screen, click Silo. The Scale icon turns brown.

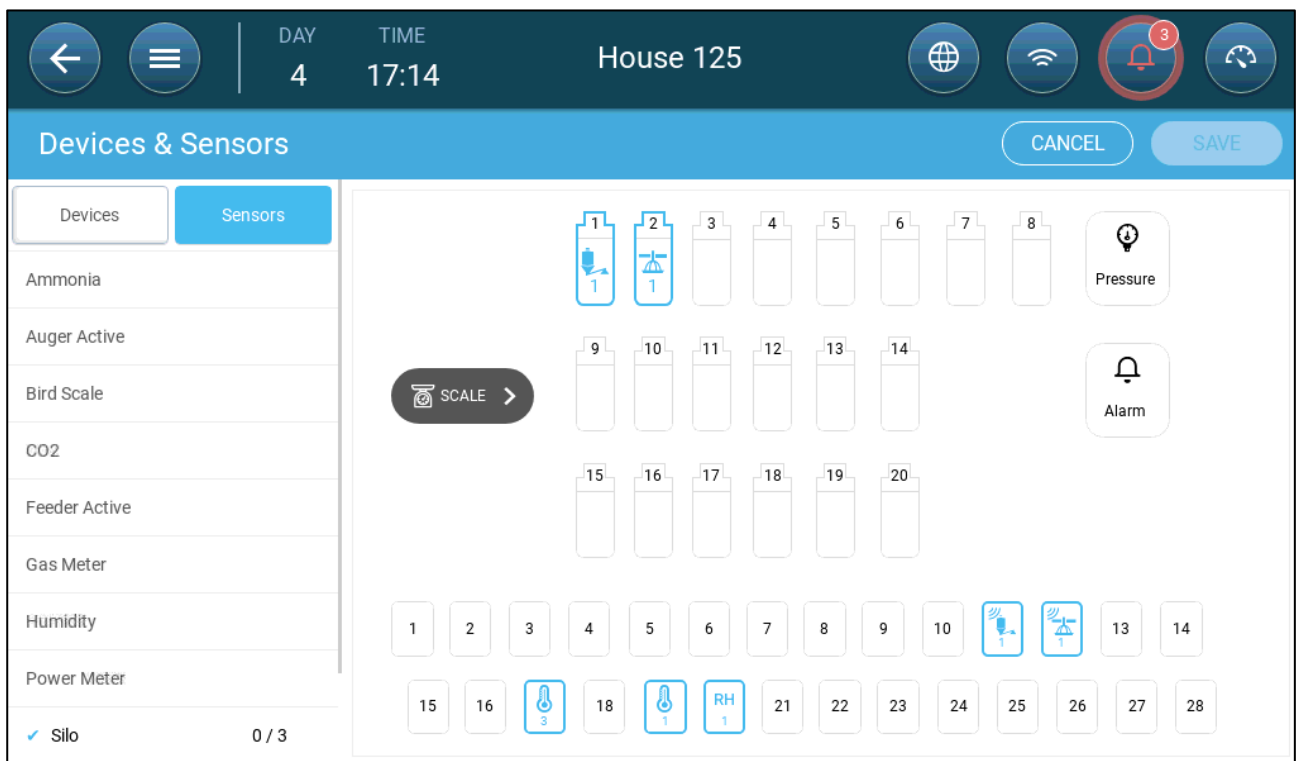

2. Click the Scale icon.

3. Select up to three channels and click Save.

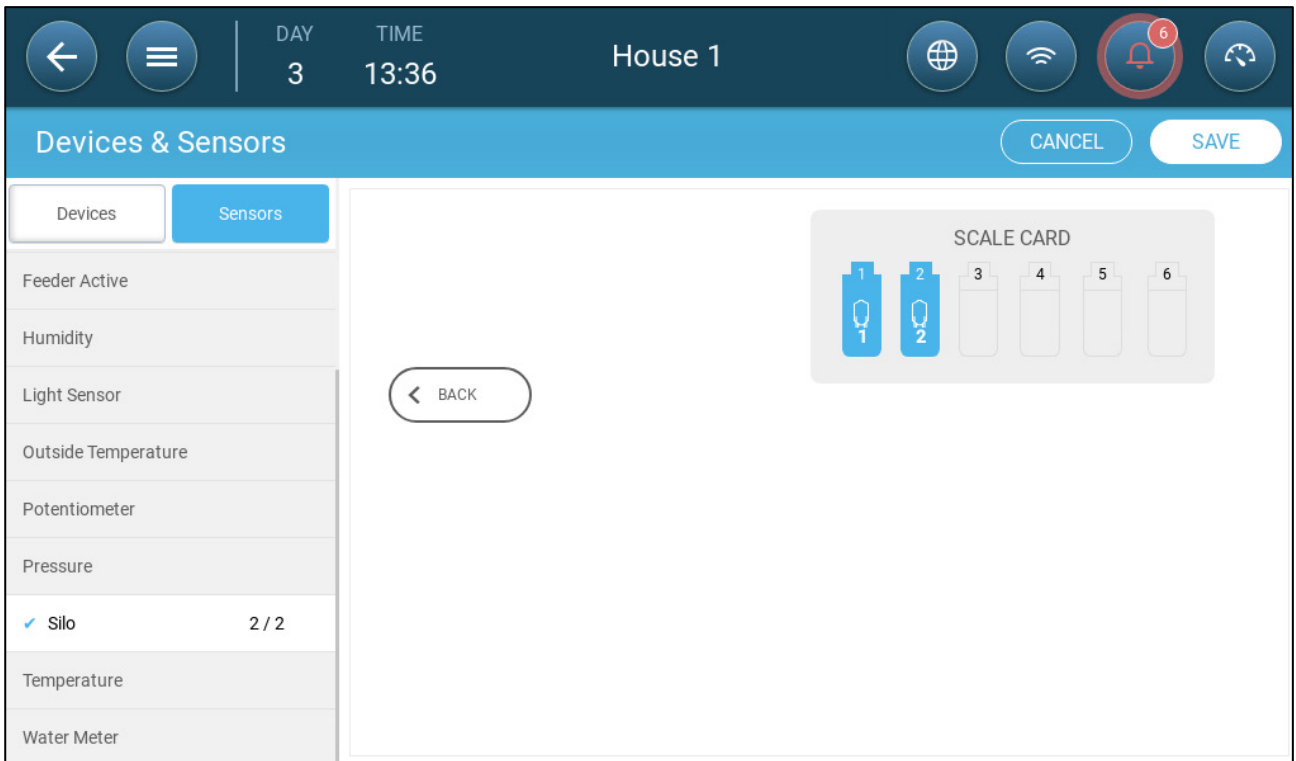

4. Click on each channel.

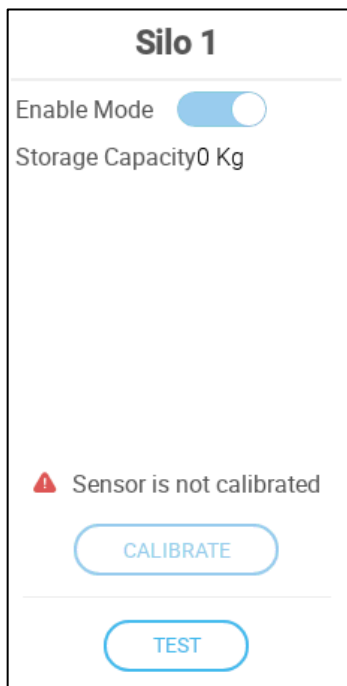

5. Define:

- Enable Mode: Enable/disable the channel.
- Storage Capacity: Define the quantity of feed that each silo can contain.
- Calibrate: Refer to the next section.

7.4.1.2 Configuring the Silo Scale

The following procedure details how to “zero out” the Trio silo scales. Zeroing out is a way to ensure that the unit’s A2D number is accurate (shown in the Silo Icon; 430 in the picture below). To summarize the procedure:

- The user enters the correct amount of feed in the silo while calibrating the silo scale. In the Silo management screen, the user enters “0” (zero). Trio then defines the current A2D signal to be the A2D signal for an empty bin.

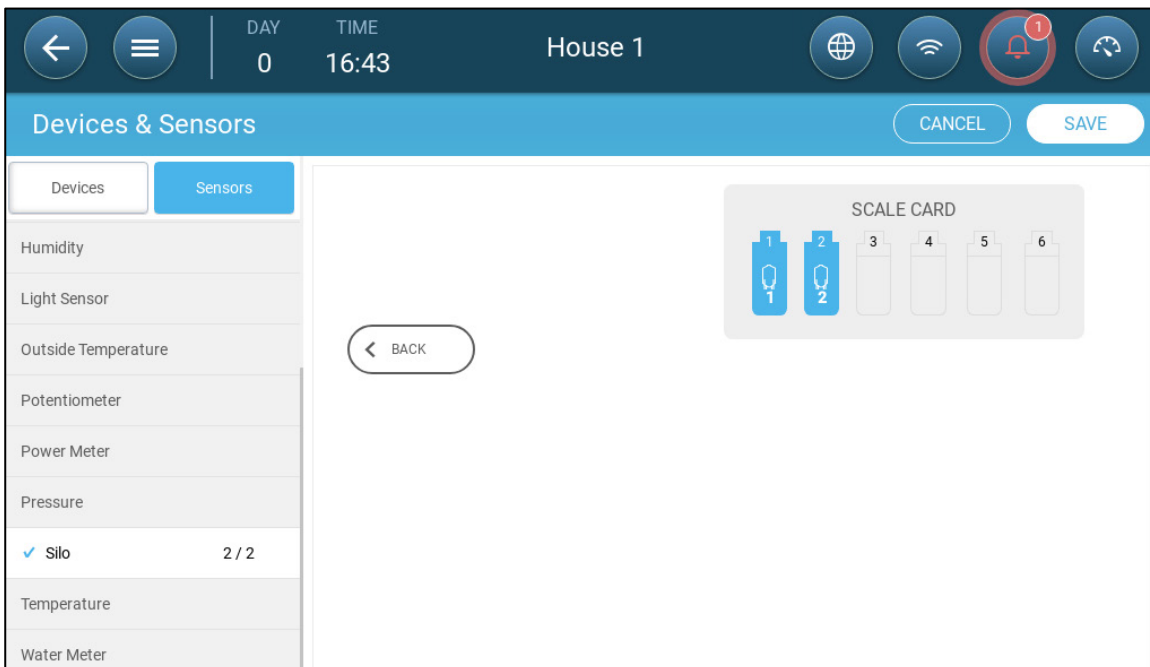
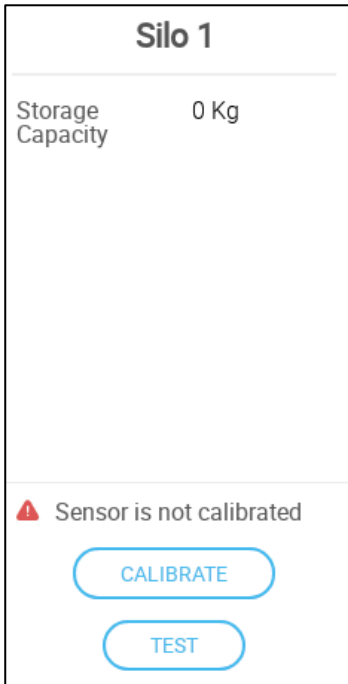

1. Define each silo’s storage capacity.
2. Click on the silo icon and click **Calibrate**. The following screen appears:

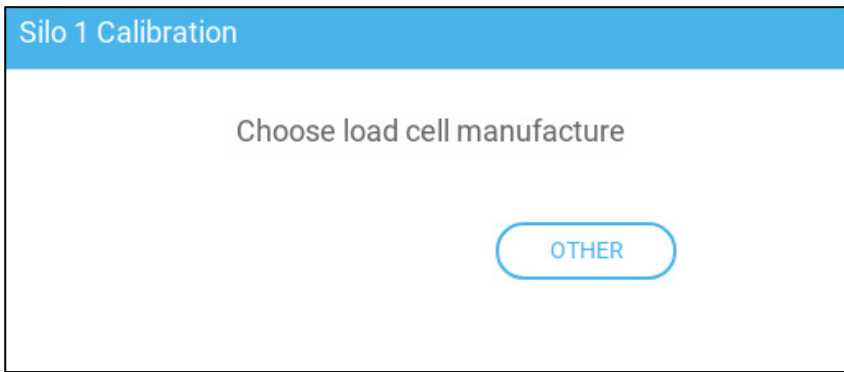

3. Click **Other**. The following screen appears:

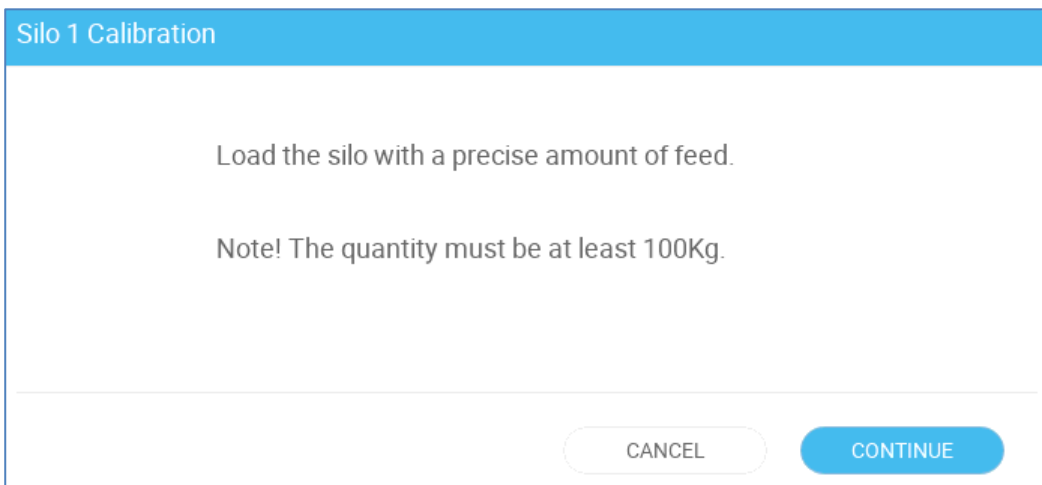

4. Fill up the silo with a known amount of feed. **Munters recommends either a truck filling or a minimum of 500 kilograms.**

5. Enter the amount of feed in the silo and press **Continue**.

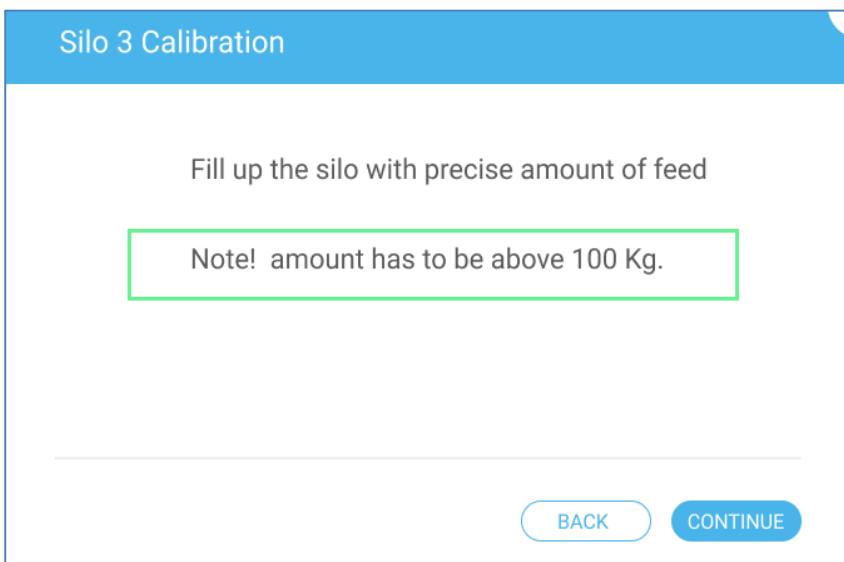

The following screen should appear.

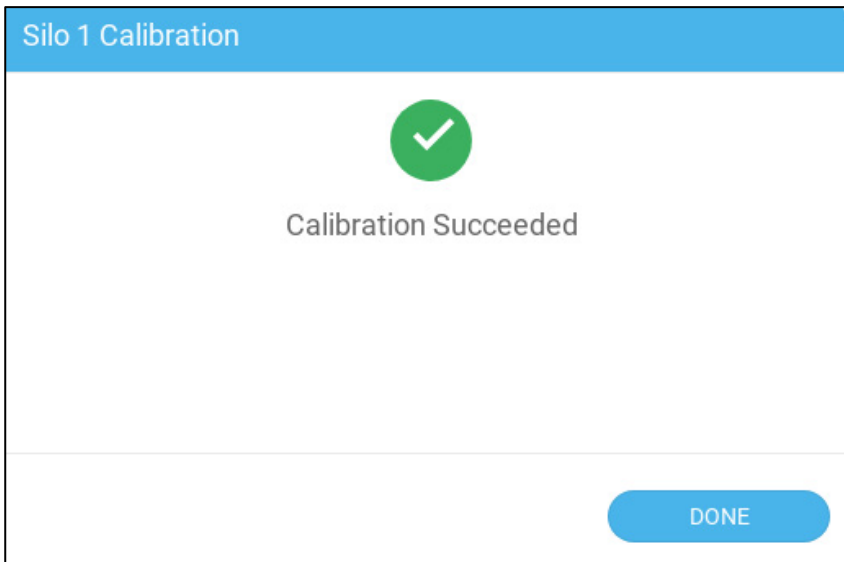

6. Go to Flock > Silo Management.

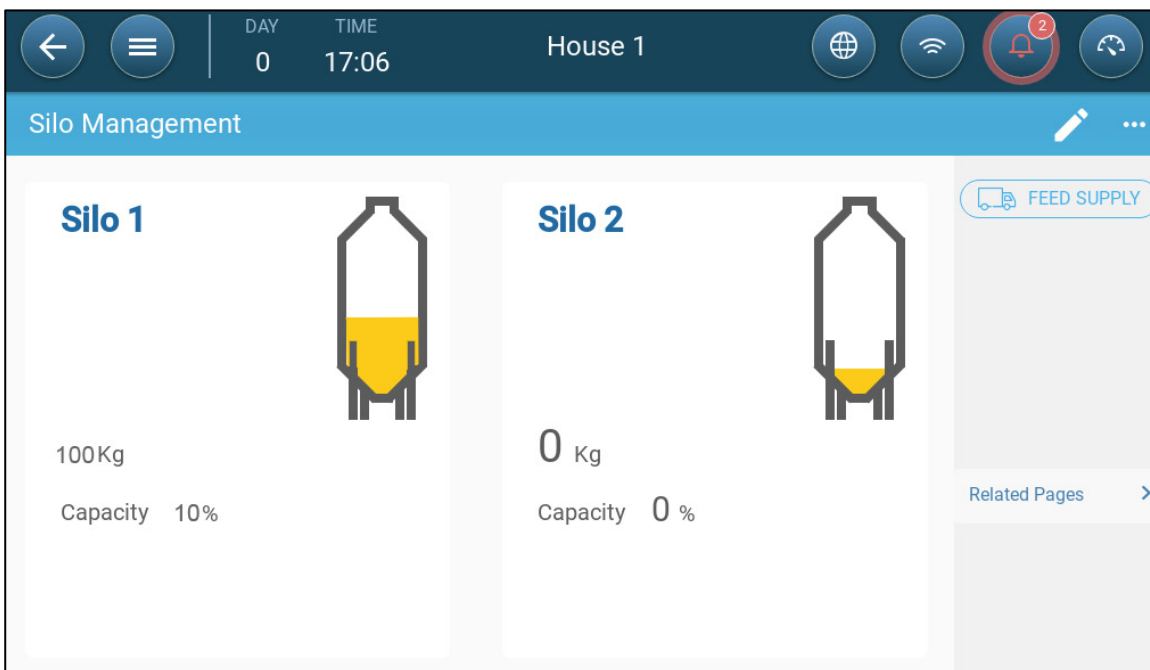

7. Click  and change the feed weight to 0.

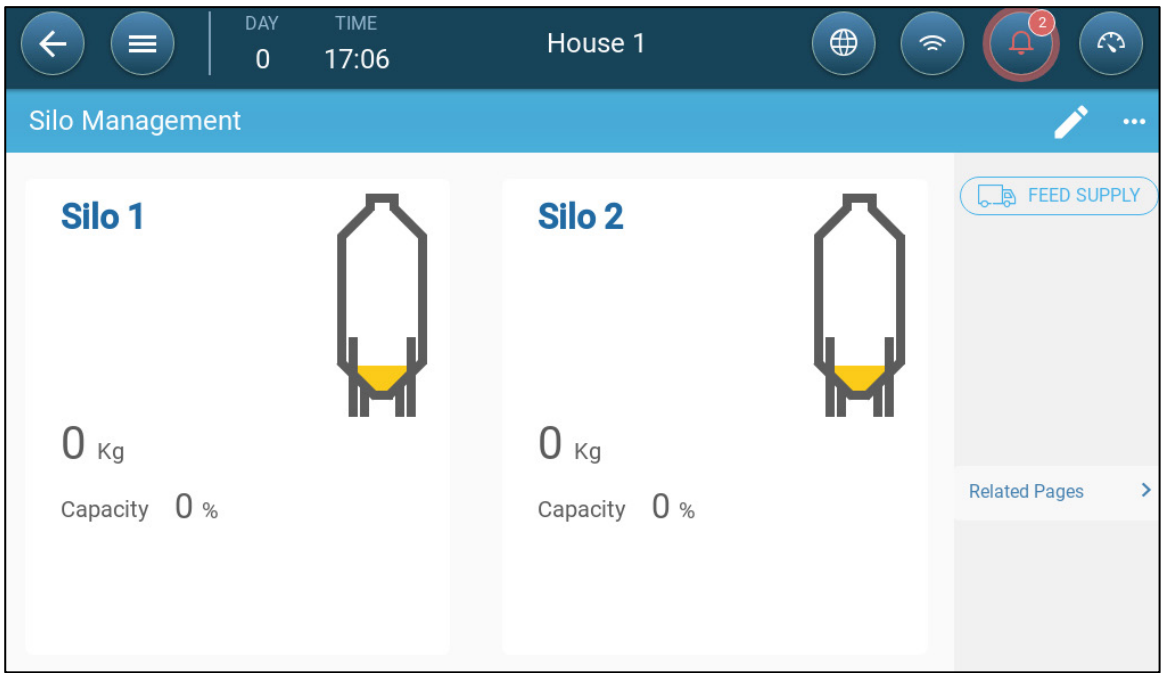

8. Click **Save**.

The Trio now displays an accurate A2D number on the silo icon screen.

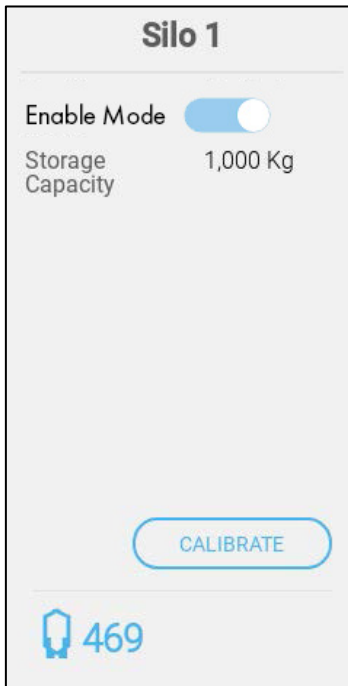

7.4.1.3 Testing the Silo

1. After calibrating the silo, go to the Silo relay.



2. Click Test.

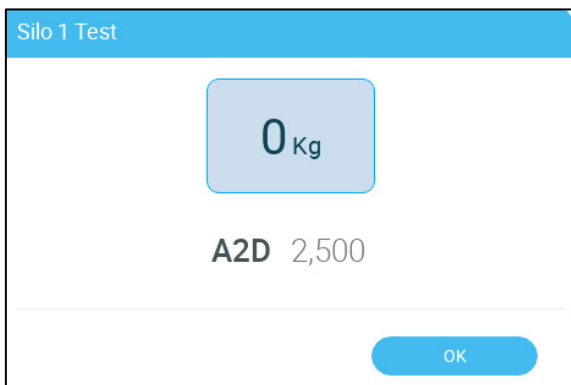

3. Place a known weight in the silo.

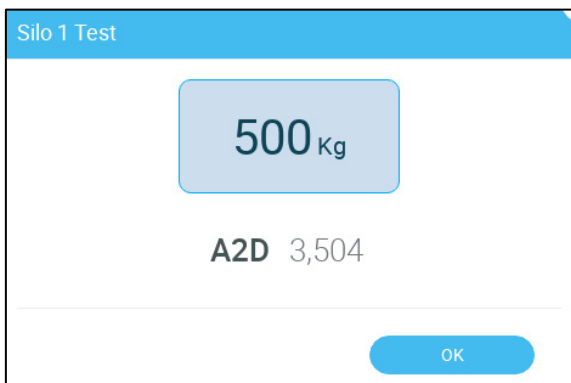

The weight should appear on the screen and the A2D level should rise.

7.4.2 DEFINING BINTRAC SILOS

TRIO can support up to three BinTrac silo scales.

➔ This function requires a scale card.

1. On the Devices & Sensors screen, click Silo. The Scale icon turns brown. Click the icon.

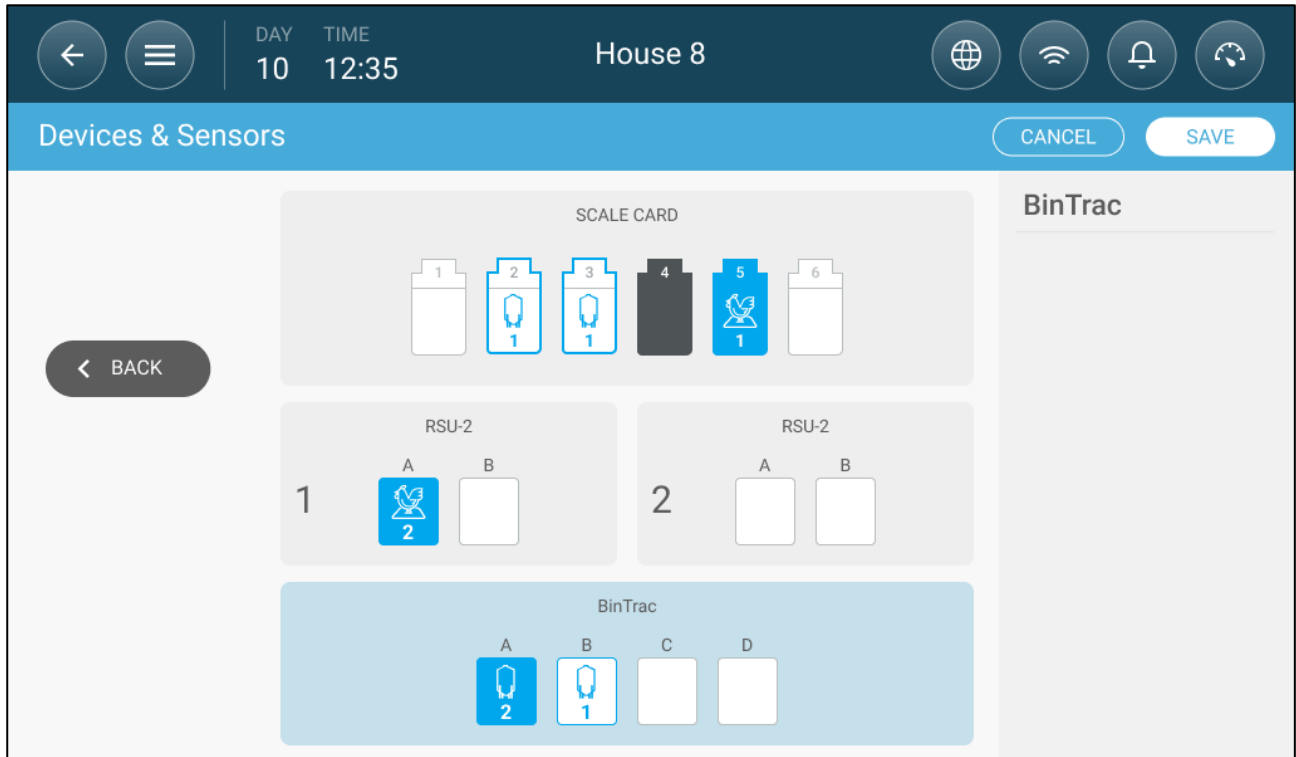

2. Define the ports as BinTrac. No parameter definitions required.

7.4.3 DEFINING THE BIRD SCALES

- Mapping the Bird Scales
 - Calibrating the Bird Scales
 - Testing the Bird Scale
- Trio can support up to four bird scales.

7.4.3.1 Mapping the Bird Scales

➡ Install a scale card.

1. On the Devices & Sensors screen, click **Bird Scale**. The Scale icon turns brown.

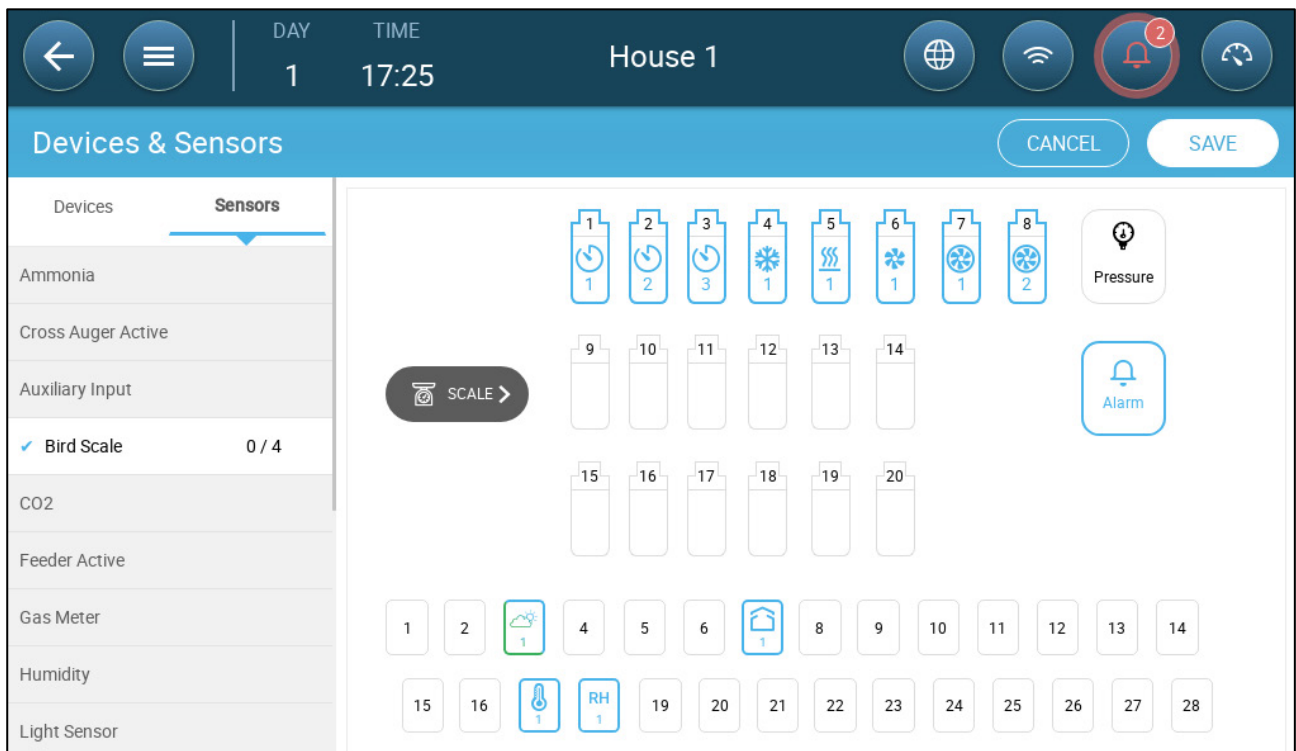

2. Click the Scale icon.

3. Define up to four channels as scales and click **Save**.

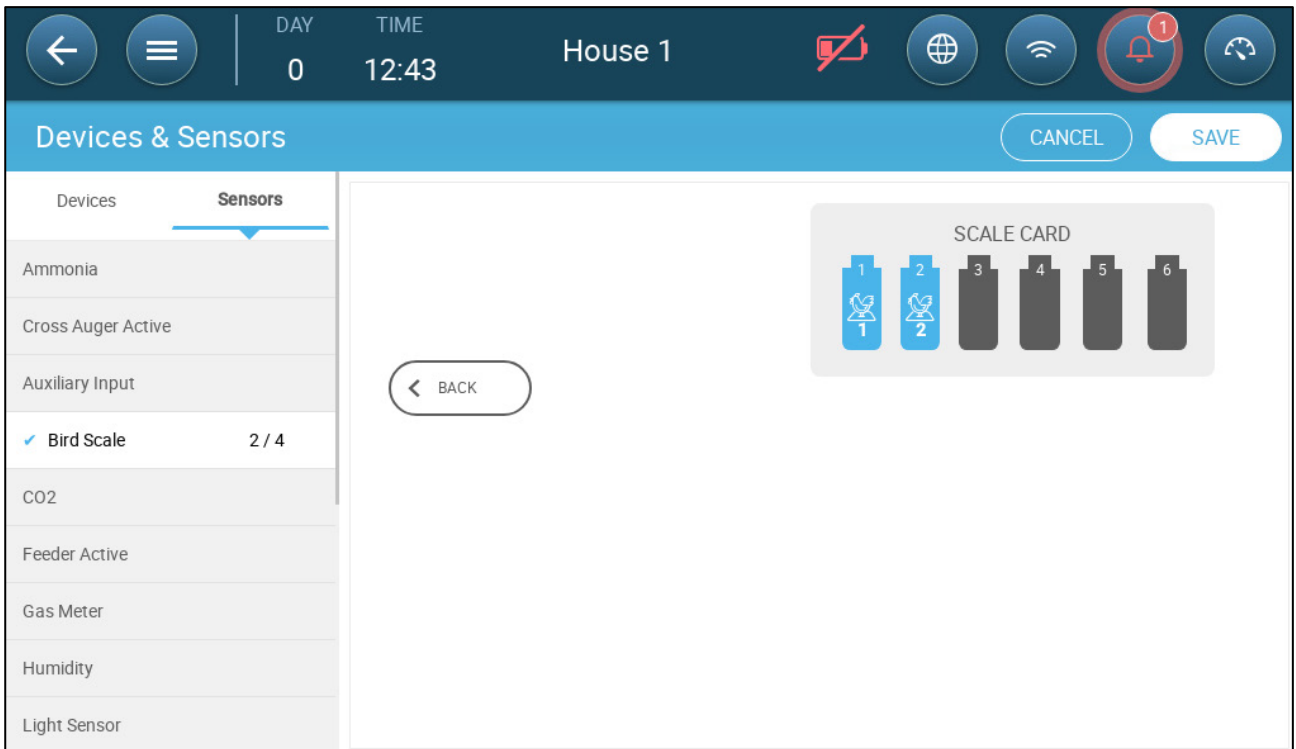

4. Verify that each channel is enabled.

7.4.3.2 Calibrating the Bird Scales

1. Click on a bird scale icon and click **Calibrate**. The following screen appears:

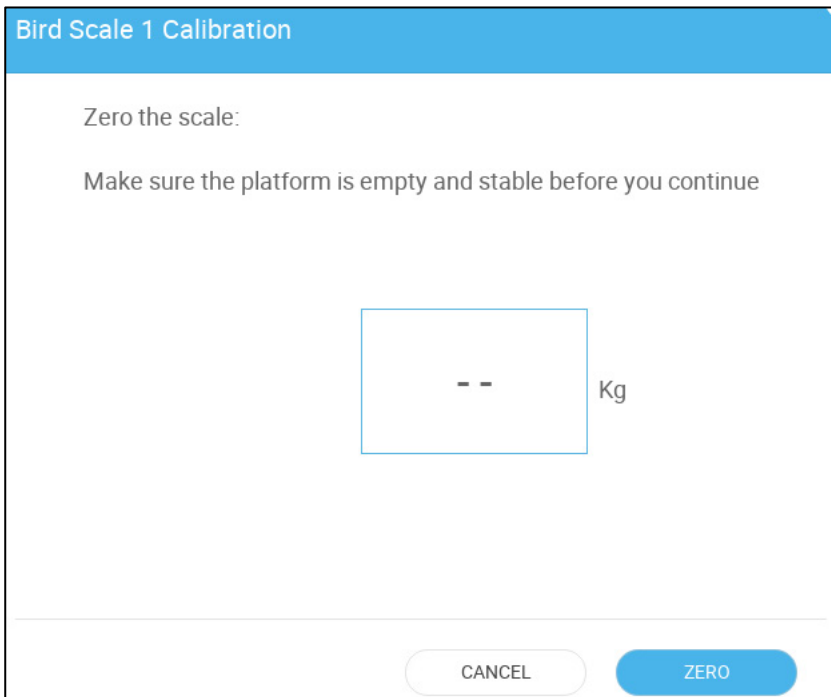

2. Remove everything from the scale and press **Zero**. In the following screen enter the weight being used to calibrate the scale; minimum is 1.0 kilogram. Click **Next**.

CAUTION The scale must be free of any objects before pressing **Next**!

Bird Scale 1 Calibration

Enter the weight being used to calibrate the scale

Caution: Do not place the weight on the scale yet!

Range 1.000 - 50.000

1	2	3
4	5	6
7	8	9
-	0	.
Enter		⌫

- 1.5 Kg +

CANCEL NEXT

3. Place a known weight on the scale (1.5 kilograms in the below example) and press **Next**.

Bird Scale 1 Calibration

Load 1.5 Kg on platform

- The load should be placed close to the center of the platform.

CANCEL NEXT

The following screen should appear:

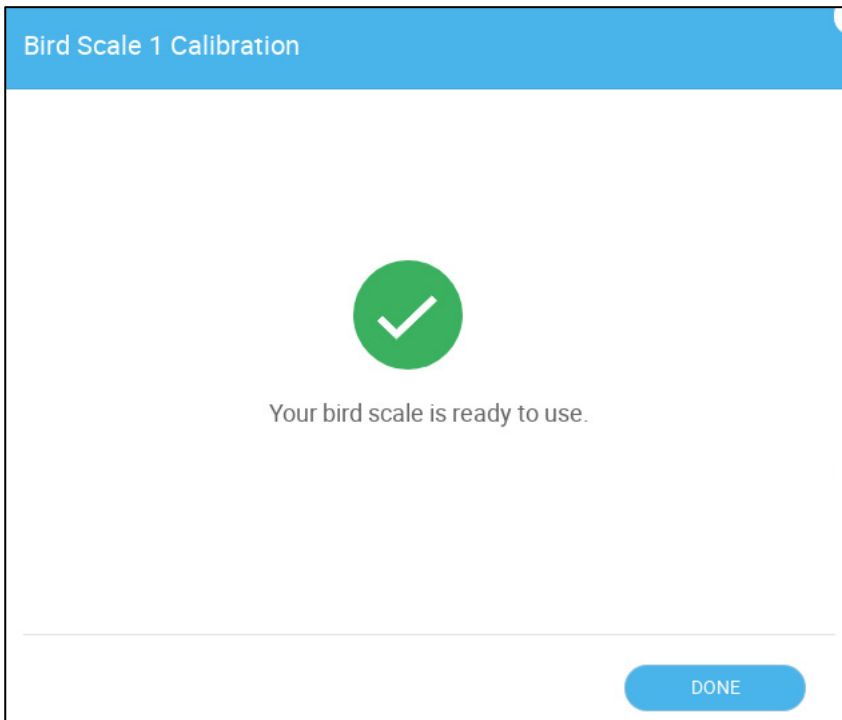

7.4.3.3 Testing the Bird Scale



1. Click Test.

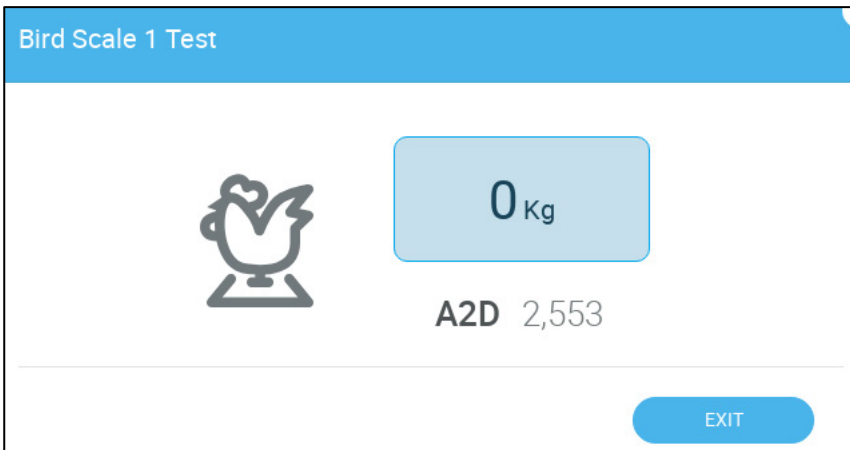

2. Place a known weight on the bird scale.

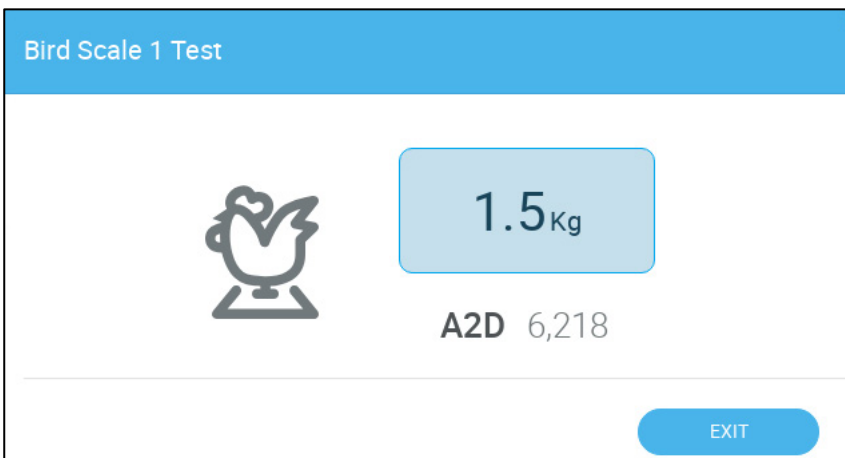

The result should be fairly close to the true weight.

7.4.4 DEFINING THE RSU

The following section details how to define up to two RSU units connected to the Trio (optional). For detailed information on using the RSU, refer to the product manual.

➡ Wire the RSU to the Trio as shown in Figure 43, page 47.

1. Reset the Trio, as shown in General Settings > About.
2. Go to Device & Sensors > Installation > Scale.

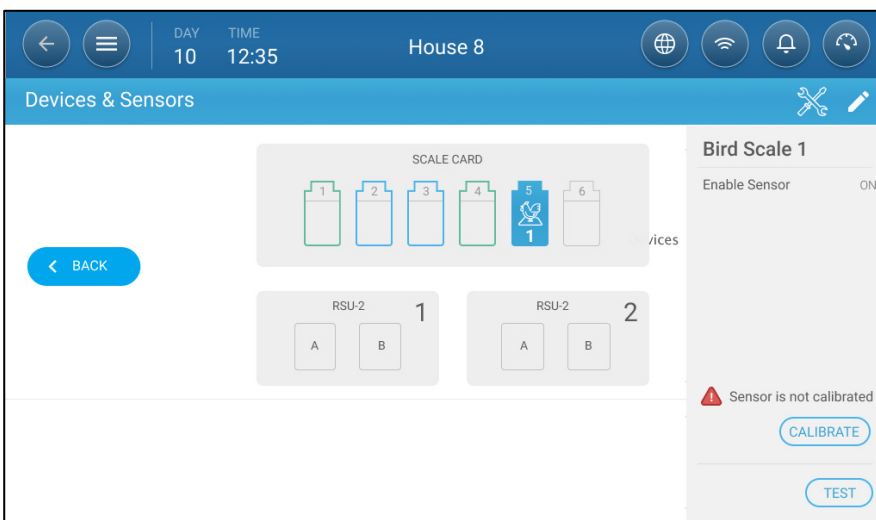

3. Click the RSU icon.
4. Click Calibrate.

Follow the instructions given in Configuring the Silo Scale, page 100.

7.5 Trio RPS

The following section details how to configure the RPS device.

- Defining the Sensor
- Static Pressure Calibration

7.5.1 DEFINING THE SENSOR

1. Go to System > Devices & Sensors.

2. Click . The Devices & Sensor screen appears.

3. Click .

4. Click Pressure.

5. Define an analog input port as the pressure sensor. In the following screen, ports 5 and 19 are defined as the pressure sensor.

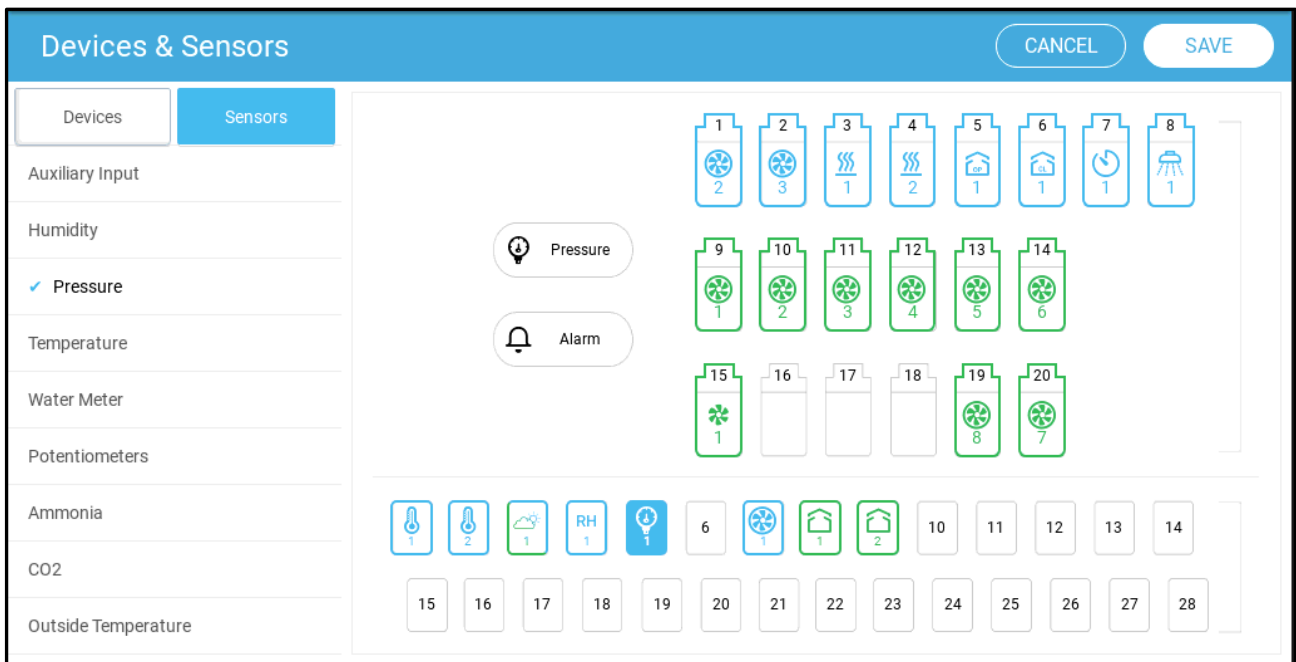

6. Go to Climate > Static Pressure and define the parameters.

7.5.2 STATIC PRESSURE CALIBRATION

CAUTION The Static Pressure sensor is factory calibrated. Only calibrate the sensor if you have reason to believe that they are producing inaccurate results.

The Static Pressure should be 0 when there is no ventilation and the house is closed. When the controller A/D counts is 100, this means that there is zero (0) static pressure.

NOTE: Run the controller for a few hours so that the temperature in the box becomes stable and only then calibrate.

CAUTION DO NOT blow the air into the hose to see if the pressure changes! The sensor is sensitive and blowing air can cause irreparable damage.

To calibrate the Static Pressure Sensor:

1. Disconnect the air hoses.
2. Go to *System > Device & Sensors > Pressure*.

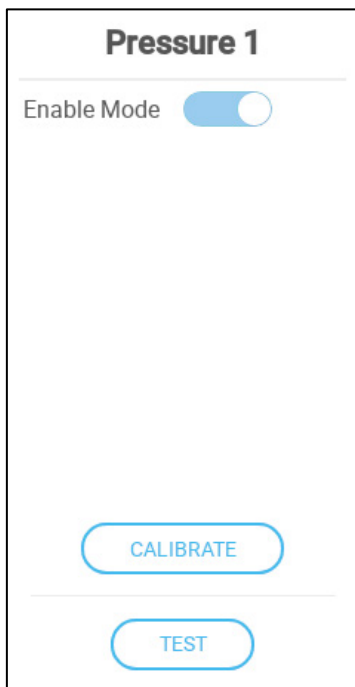

3. Click **Calibrate**.

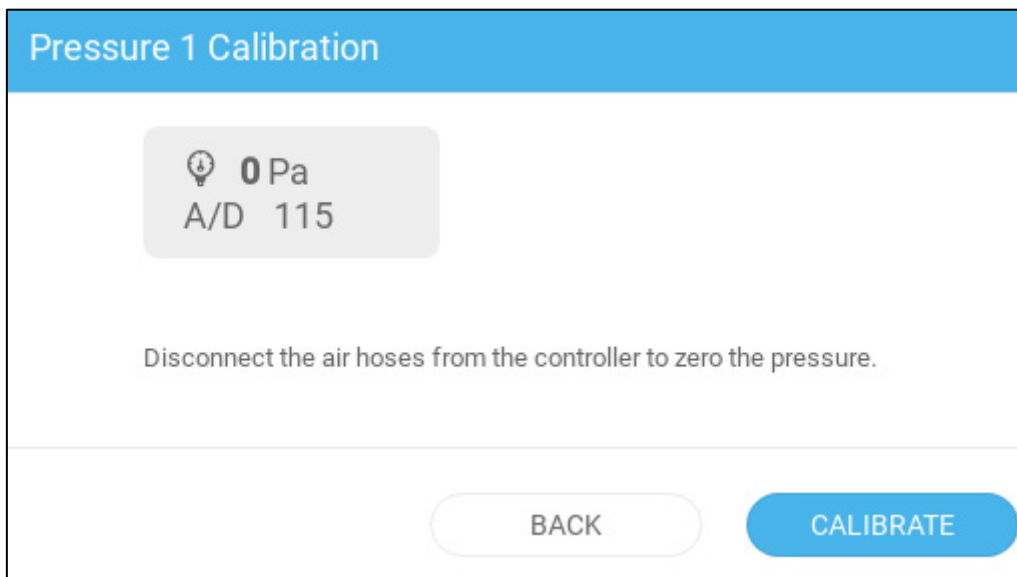

4. If the A/D count is 100 +/- 30 (70 to 130), click **Calibrate**.
5. If the A/D count is less than 70 or greater than 130:
 - a. Check for blocked air hoses or wind interference.
 - b. Open the Trio. On the Main Board, find the Static Pressure Sensor.

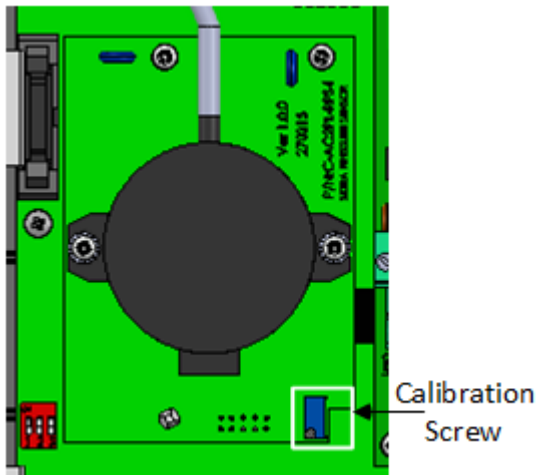

- c. Adjust the zero pressure reading to approximately 100 by turning the calibration screw.
- d. When the A/D count is within the permitted range, press **Calibrate**.

7.6 Testing Devices

After mapping a device, Trio provides a testing function that enables checking the device's performance.

- Fans: Click Test to test the fan's response.

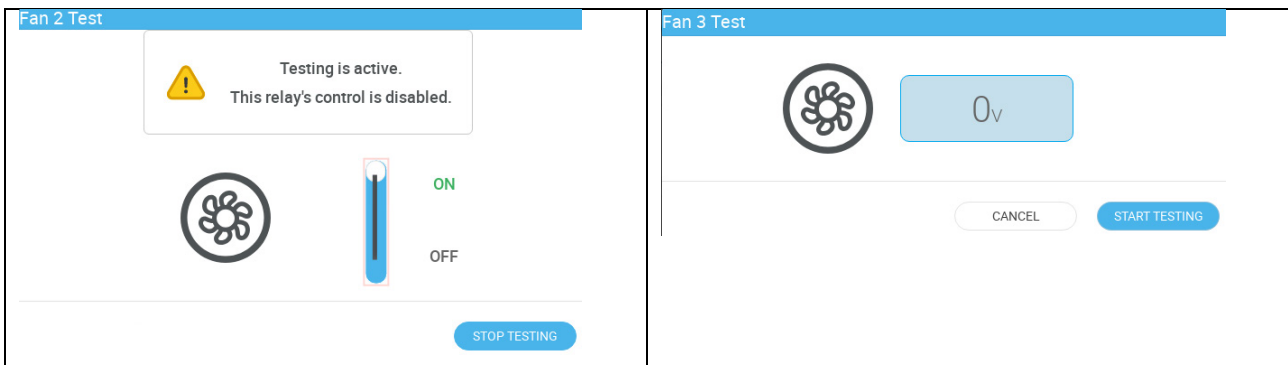

- Relay devices: Click Test > On to ensure that the device turns on.

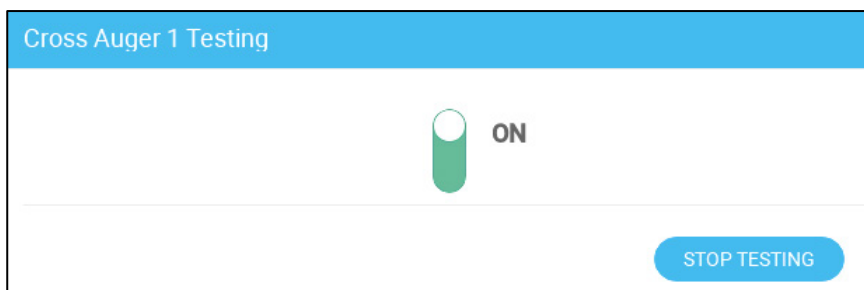

- Analog output devices: Click Test and move the voltage scale to ensure that the device operates at the proper minimum and maximum voltage levels.

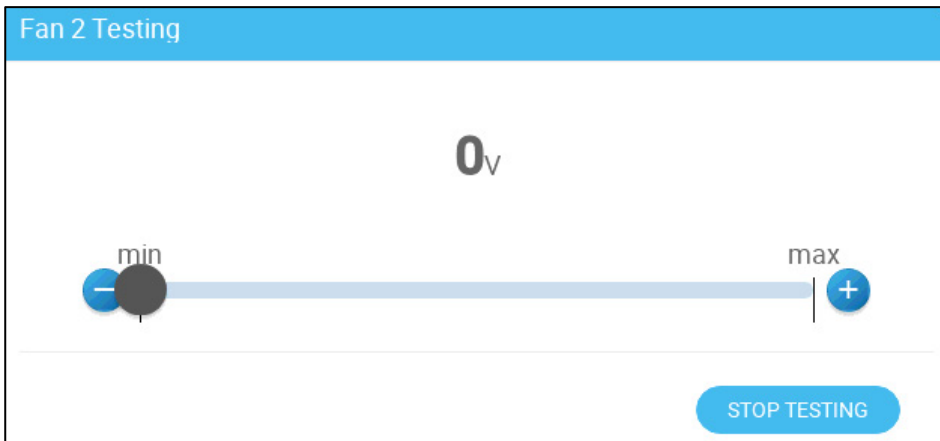

- Analog input devices: Click Test to view the current input results and A2D value. The test function also displays an error message when the input signal is weak or non-existent.

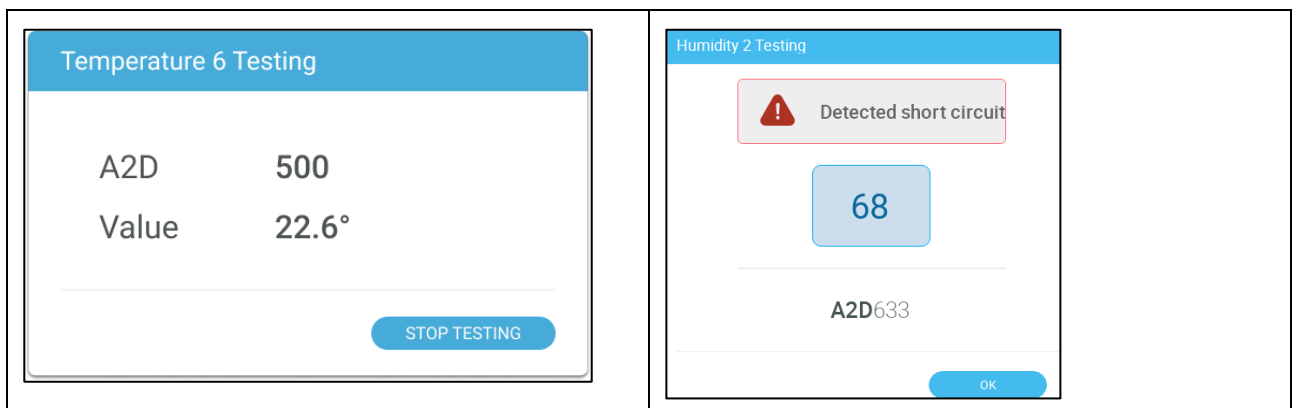

- Acceptable ranges:
 - RTS-2: 200 – 600.
- Digital input devices: Click Test to view the current circuit status (signal close or signal open).

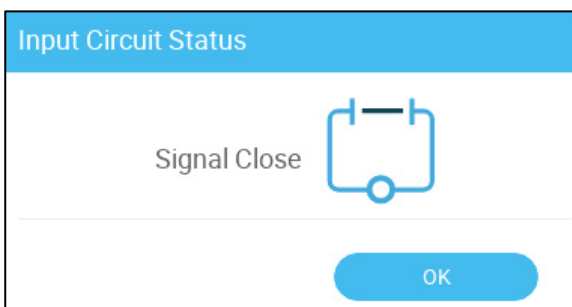

8 Appendix A: External Devices (Previous Versions)

The following section details the relays and analog/digital ports found in previous software versions.

Table 5: Trio 20 Poultry STD - Version 5

Device type	Maximum Number of Devices	Number of Relay Devices	Number of Analog Devices
Cooling	2	2	N/A
Heaters	6	6	6
Inlets	2	2	2
Outlets	1	N/A	1
Tunnel Doors/Curtains	2	2	2
Fans Exhaust/Tunnel	20	20	8
Stir Fan	2	1	1
Lights	4	4	4
Timer	5	5	N/A
Auger	2	2	N/A
Feeder	4	4	N/A
Lighting	4	4	N/A
As Relay	30	30	N/A
As Analog Out	8	NA	8
Alarm	1	1	N/A

Device type	Analog Sensors	Digital Sensors
Temperature Sensors	12	N/A
Humidity Sensors	2	N/A
Outside Humidity Sensor	1	N/A
CO2 Sensors	1	N/A
Ammonia Sensors	1	N/A
Pressure Sensors	2	N/A
Potentiometers	4	N/A
Bird Weighing	4	N/A
Silo Weighing	2	N/A
Lux Meter (light intensity)	1	N/A
Water Meters	N/A	4
Gas Meters	N/A	3
Aux. Input	N/A	4
Auger Sensor	N/A	2
Feeder Line Sensor	N/A	4

Table 6: Trio 20 Poultry STD - Version 4

Name	Output			Measurements	
	Total	Relay	0-10V	Analog	Digital
Cooling	2	2			
Heaters	6	6	6		
Inlets	2	2	2		
Outlets	1	NA	1		
Tunnel Doors/Curtains	2	2	2		
Fans Exhaust/Tunnel	20	20	8		
Stir Fan	1	1	1		
Timer	5	5			
Auger	2	2			
Feeder	4	4			
Lighting	4	4	4		
As Relay	30	30	NA		
As Analog Output	8	NA	8		
Alarm	1	1			
Temperature Sensors				12	
Humidity Sensors IN				1	
CO2 Sensors				1	
Ammonia Sensors				1	

	Output			Measurements	
Pressure Sensors				1	
Potentiometers				4	
Power Meter				2	
Gas Meter				2	
Lux Meter				1	
Bird Weighing				2	
Silo Weighing				2	
Water Meters					1
Aux. Input					4
Auger Sensor					2
Feeder Line Sensor					4

Table 7: Trio 20 Poultry STD - Version 3

	Output			Measurements	
Name	Total	Relay	0-10V	Analog	Digital
Cooling	2	2			
Heaters	4	4	4		
Inlets	2	2	2		
Outlets	1	NA	1		
Tunnel Doors/Curtains	2	2	2		
Fans Exhaust/Tunnel	12	12	8		
Stir Fan	1	1	1		
Timer	5	5			
Auger	2	2			
Feeder	4	4			
Lighting	4	4	4		
As Relay	20	20	NA		
As Analog Output	8	NA	8		
Alarm	1	1			
Temperature Sensors				12	
Humidity Sensors IN				1	
CO2 Sensors				1	
Ammonia Sensors				1	
Pressure Sensors				1	
Potentiometers				4	
Power Meter				X	
Gas Meter				X	
Lux Meter				1	
Bird Weighing				2	
Silo Weighing				2	

	Output			Measurements	
Water Meters					1
Aux. Input					4
Auger Sensor					2
Feeder Line Sensor					4

9 Appendix B: Service Manual

- Maintenance
- Trouble Shooting
- Spare Parts

9.1 Maintenance

Perform the following steps to maintain your unit.

- Checking the Battery Level: Check the battery once a year. The output must be 2.7 volts (minimum). Authorized personnel only must replace the battery if the output is below the minimum required level or every five years.
- Visually inspect your unit once a year. Make sure that there are no signs of corrosion or residue on the PCBs. If these issues appear, it means that:
 - the Trio is installed in an environment with high humidity, ammonia content, or some other destructive agent.
 - There is a lack of (silicon) sealing or that the sealing has degraded.
- Make sure that the silicon seal around the PGs installed in the knockouts is not cracked.
- Check that the gasket is not cracked.

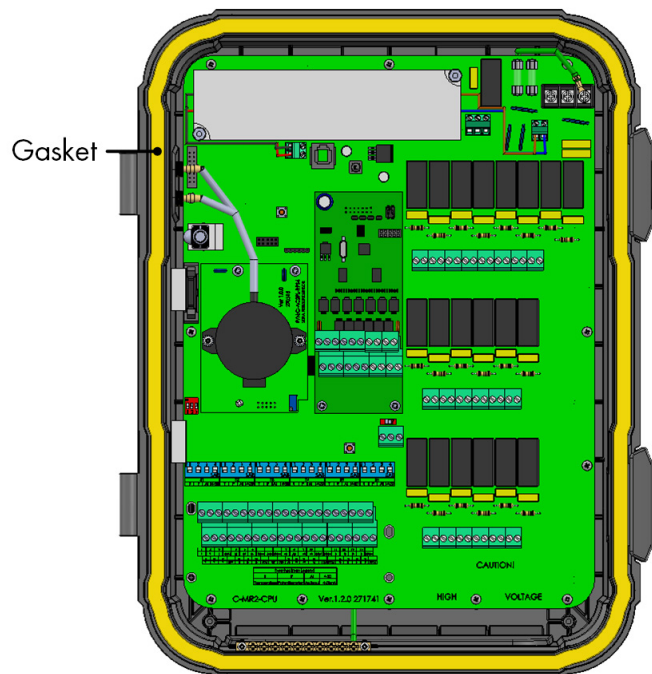

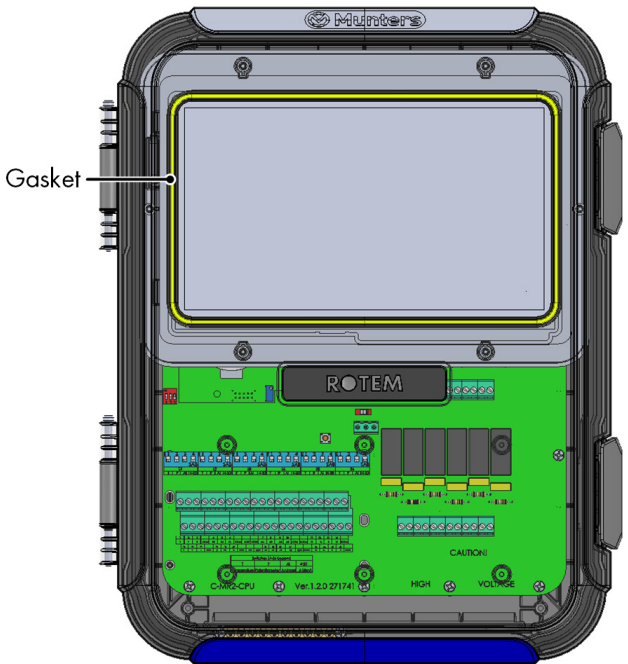
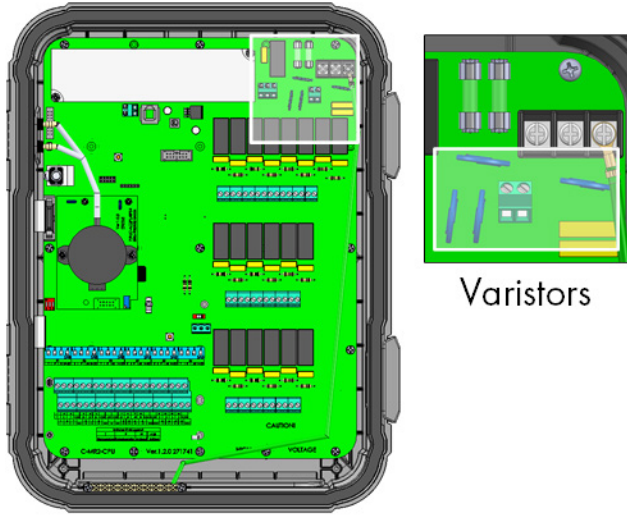
<ul style="list-style-type: none"> • Check that the gasket around the touch screen is not cracked. 	 <p>A top-down view of the back of a Munters ROTEM unit. The touch screen is at the top, surrounded by a yellow gasket. Below it is the green PCB with various components. A label 'Gasket' points to the yellow seal around the screen.</p>
<ul style="list-style-type: none"> • Look for any signs of burns or browning around the varistors. 	 <p>A top-down view of the back of a Munters ROTEM unit. An inset image on the right shows a close-up of the PCB with three blue varistors. A label 'Varistors' points to this inset.</p>
<ul style="list-style-type: none"> • Inspect the shield wiring and main grounding cable; ensure that they are properly connected to the proper ports. 	

9.2 Trouble Shooting

- Internet
- Electronic Components

9.2.1 INTERNET

The following section describes how to trouble shoot internet problems. In the event that there is no internet connection:

1. Go to System > General Settings > Network Screen. Verify that there is an IP address.
2. Check the cable connections between the switch and the Trio.
3. Verify that the unit is powered.

NOTE If there is no internet connection, the Main Menu Internet icon is marked.



9.2.2 ELECTRONIC COMPONENTS

Problem: The touch screen doesn't turn on up after applying 115/230VAC.

Solution: Open the Trio door and:

1. Check main 115/230VAC 3A fuse F2.
 - If required, replace fuse.
2. Check the 12V terminal voltage (COM & 12V).
 - If there is no voltage, there is a problem with the Switched Power Supply. Replace the power supply.
3. Verify that the 5V and 3.3V indicative LEDs of the I/O power board are lit.
4. Verify that the flat cable connecting the I/O board and the display board is in place.
5. Verify that the Green Status LED is flashing.
6. On the Trio display board, verify that the:
 - RED Status LED is flashing
 - Display's flat cable is firmly hooked up to its connector.

Problem: The screen doesn't reflect changes made in the analog inputs.

Solution:

1. Verify that the position of Dip Switch (S1-S6) corresponds with the relevant analog input.
2. Verify that the analog input terminals' mapping corresponds to the actual wiring.
3. Check that the terminal wire connection of Analog Input of interest coincides with the analog input chosen on the touch screen.

Problem: The screen doesn't reflect the changes in digital inputs.

Solution: Verify that the digital input terminals' mapping corresponds to the actual wiring.

Problem: The Alarm Relay doesn't operate.

Solution: Check fuse F4.

- By default, alarm relay contacts "NO-COM" should be closed.

Problem: The analog output voltage doesn't correspond to the voltage defined on the corresponding analog output terminal.

Solution: Check the load value. The maximum analog output load is 15 mA.

Problem: An analog output terminal has no output voltage.

Solution: Verify that the analog output terminals' mapping corresponds to the actual wiring.

Problem: The display screen appears but does not respond to any touch.

Solution: Check the USB cable between the touch screen card and the Trio display card.

Problem: There is no 3.3V output for to power the potentiometer(s).

Solution: There is a PPTC fuse F1 on the 3.3V line. Disconnect the potentiometers and using a DVM, check the resistance on the terminal between the 12V output and common ground (COM). The reading should indicate an open circuit.

- If not, the line is damaged.

Problem: The end user doesn't see changes in the data tables.

Solution:

1. Check the Internet cable, going from RJ-45 connector (marked as Ethernet-2). Verify that the connector's LEDs are flashing.
2. Check the Internet cable, going from the power card to the Trio display's card RJ-45 connector (marked as Ethernet-1). Verify that the connector's LEDs are flashing.

9.3 Spare Parts

- Preliminary Information
- Trio Minimal Spare Parts
- Trio 20 Door Card Spare Parts
- Trio 20 Main Container Spare Parts
- Additional Options
- Cards

9.3.1 PRELIMINARY INFORMATION

	Trio 20
Container	A
Door Cards	B
Main Container Cards	C
Cables and Harnesses	D
MPN	Munters Part Number
DPN	Distributor Part Number

9.3.2 TRIO MINIMAL SPARE PARTS

Munters Israel recommends that managers of farms equipped with Trio Controllers keep (as a minimum stock) the following spare parts on hand. Doing so simplifies maintenance and repairs of the Trio units.

9.3.2.1 Global Customers

P/N	Description
940-99-00002	TRIO-20 LCD KIT (DISPLAY + LVDS CARD + USB CABLE) (SP-250061)
940-99-00003	TRIO-20 CPU (TRIO 20-MAIN)
940-99-00004	TRIO 20 DISPLAY CARD (TRIO-DISPLAY)
940-99-00008	TRIO 20-POU-SOM VARISCITE CARD WITH HEATSINK AND FAN
940-99-00034	TRIO 20-POU-DISPLAY CARD AND SOM VARISCITE CARD WITH HEATSINK AND FAN
940-99-00040	TRIO 20-PIG-EN-SOM VARISCITE CARD WITH HEATSINK AND FAN
940-99-00041	TRIO 20-PIG-EN-DISPLAY CARD AND SOM VARISCITE CARD WITH HEATSINK AND FAN

9.3.2.2 Chinese Customers

P/N	Description
940-99-00002	TRIO-20 LCD KIT (DISPLAY + LVDS CARD + USB CABLE) (SP-250061)
940-99-00003	TRIO-20 CPU (TRIO 20-MAIN)
940-99-00004	TRIO 20 DISPLAY CARD (TRIO-DISPLAY)
940-99-00032	TRIO 20-POU-CN-DISPLAY CARD AND SOM VARISCITE CARD WITH HEATSINK AND FAN
940-99-00042	TRIO 20-PIG-CN-SOM VARISCITE CARD WITH HEATSINK AND FAN
940-99-00043	TRIO 20-PIG-CN-DISPLAY CARD AND SOM VARISCITE CARD WITH HEATSINK AND FAN
940-99-00044	TRIO 20-POU-CN-SOM VARISCITE CARD WITH HEATSINK AND FAN

9.3.3 TRIO 20 CONTAINER SPARE PARTS



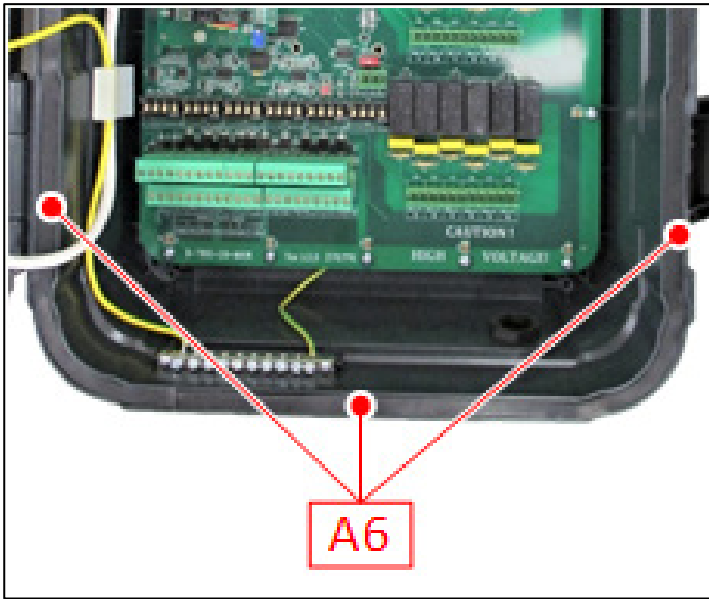

ID No.	Description	Order Catalog Number	Note
A1.1	Trio-20 FRONT DOOR TOUCH PLASTIC PART	MPN: 940-99-00005 DPN:	
A1.2	Trio-20 PLASTIC BOX BASE (SP - 207124)	MPN: 940-99-00112 DPN:	
A1.3	Trio HINGE PLASTIC PIN V1.0.0 (SP-207128)	MPN: 940-99-00019 DPN:	
A2.1	Trio-20 PANEL PLASTIC PART BLUE LOGO MUNTERS + PART BLUE	MPN: 940-99-00001 DPN:	OR
A2.2	Trio PANEL PLASTIC PART RED RAL 3020 NO LOGO (SP-207138)	MPN: 940-99-00045 DPN:	
A3.1	ONE / ONE PRO - LATCH GENERAL LOCK PLASTIC PART + LOCK FOR LATCH	MPN: 900-99-00217 DPN:	
A3.2	GENERAL PLASTIC LATCH	MPN: 900-99-00216 DPN:	
A4	Trio-20 LCD HOLDER V1.0.0 (SP-207125)	MPN: 940-99-00024 DPN:	
A5	P4 SCREEN GASKET SILICONE 35 SHORE 75CM (EXTRUSION PROCESS) (SP-204079)	MPN: 940-99-00020 DPN:	
A6	MID-RANGE MAIN GASKET V1.0.0 (SP-207122)	MPN: 940-99-00021 DPN:	

9.3.4 TRIO 20 DOOR CARD SPARE PARTS

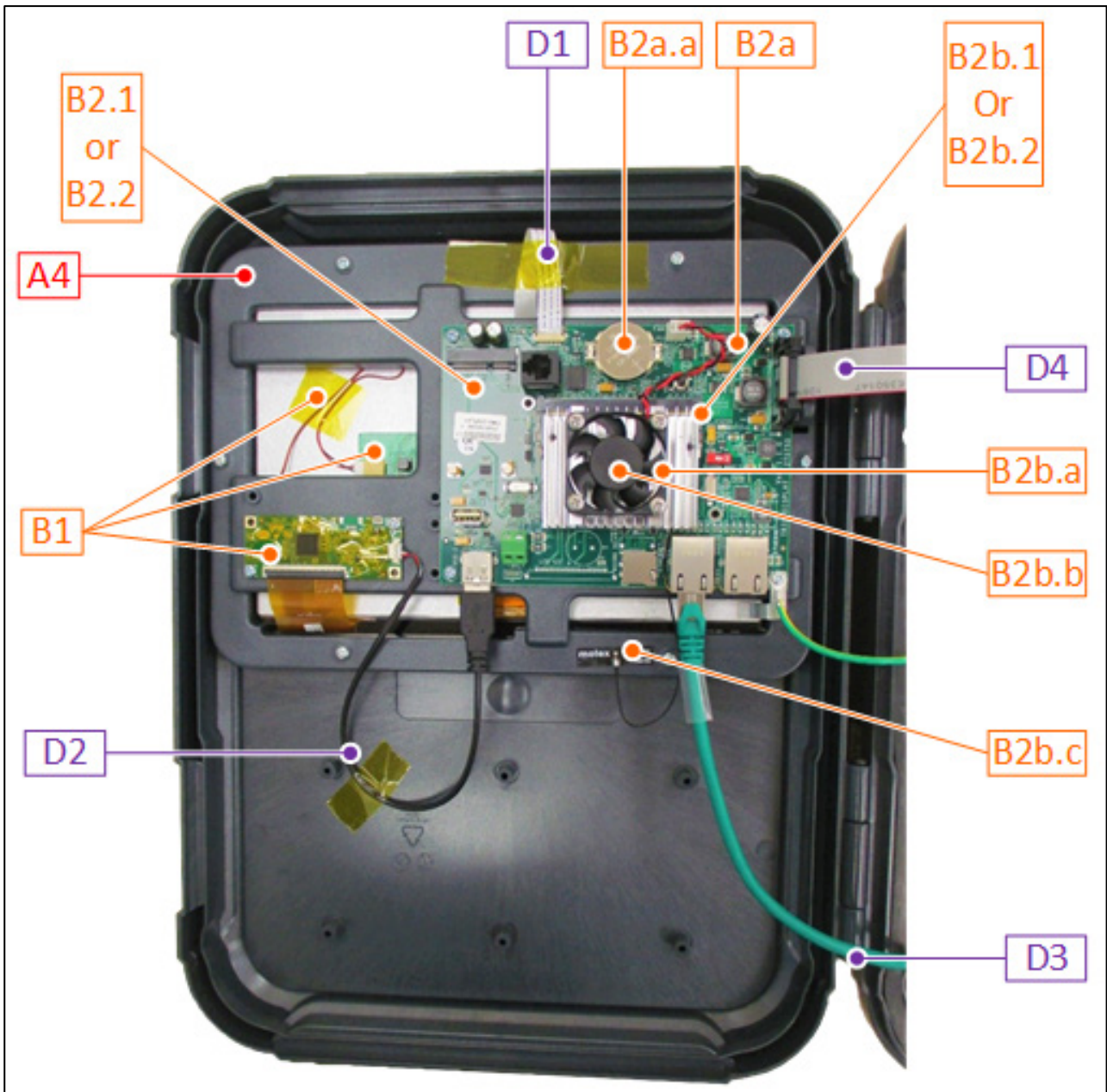

ID No.	Description	Order Catalog Number	Note
B1	Trio-20 LCD KIT (DISPLAY + LVDS CARD), [+ USB CABLE *]	MPN: 940-99-00002	
		DPN:	
B2.1	Trio 20 -POU- DISPLAY CARD AND SOM VARISCITE CARD WITH HEATSINK AND FAN	MPN: 940-99-00034	OR
		DPN:	
B2.2	Trio 20 -POU-CN- DISPLAY CARD AND SOM VARISCITE CARD WITH HEATSINK AND FAN	MPN: 940-99-00032	CHINA ONLY
		DPN:	
B2a	Trio 20 DISPLAY CARD (Trio-DISPLAY)	MPN: 940-99-00004	
		DPN:	
B2a.a	BAT COIN 3V FOR SOCKET(SP-450009)	MPN: 999-99-00386	
		DPN:	
B2b.1	Trio 20 -POU- SOM VARISCITE CARD WITH HEATSINK AND FAN	MPN: 940-99-00008	OR
		DPN:	
B2b.2	Trio 20 -POU-CN- SOM VARISCITE CARD WITH HEATSINK AND FAN	MPN: 940-99-00044	CHINA ONLY
		DPN:	
B2b.a	Trio 20 HEATSINK AND FAN FOR SOM CARD	MPN: 940-99-00026	
		DPN:	
B2b.b	FAN FOR Trio SOM CARD (SP-204152)	MPN: 940-99-00025	
		DPN:	
B2b.c	Trio 20 ANTENNA WIFI MOLEX 15cm CABLE U.FL/I-PEX MHF 2.4GHz 2.8dBi 50ohm (SP-491009)	MPN: 940-99-00035	
		DPN:	

ID No.	Description	Order Catalog Number
D1	VIDEO FLAT CABLE 0.02" (0.50 mm) Type 1,152.4 mm	MPN: 940-99-00012
		DPN:
D2	USB CABLE FOR Vitek\Ampire DISPLAY (SP-140672)	MPN: 940-99-00027
		DPN:
D3	NETWORK CABLE RJ485 (8 WIRES, 0.5 METERS)	MPN: 940-99-00011
		DPN:
D4	FLAT FF14P 25CM F"D>_V1.0.0 (SP-141161)	MPN: 999-99-00457
		DPN:

ID No.	Description	Order Catalog Number	Note
C1	Trio-20 MAIN CARD (Trio-20 MAIN)	MPN: 940-99-00003	
		DPN:	
C1.1	SWPS LPV-60-12 Mean Well 100-240V 12V 60W (SP-370193)	MPN: 900-99-00264	
		DPN:	
C2	STATIC PRESSURE SET - AC3G / SE / PL / Trio - POU (WITH EXTERNAL TUBE)	MPN: 901-99-00025	
		DPN:	
C3.1	Trio 20 SCALE CARD 2SCL (Trio-RSC-2)	MPN: 940-99-00013	OR
		DPN:	
C3.2	Trio 20 SCALE CARD 2SCL (Trio-RSC-6)	MPN: 940-99-00014	
		DPN:	



ID No.	Description	Order Catalog Number
C4	BAT COIN 3V FOR SOCKET(SP-450009)	MPN: 999-99-00386 DPN:



9.3.6 ADDITIONAL OPTIONS

ID No.	Description	Order Cat. No.	Remarks
ADO 1	TEMPERATURE SENSOR BLACK-RTS-2-POU	MPN: 918-01-00001	
		DPN:	
ADO 2	HUMIDITY SENSOR-RHS-POU-ROT-SE-10PL	MPN: 917-02-00003	
		DPN:	
ADO 3	STATIC PRESSURE SET - AC3G/SE/PL/Trio - POU	MPN: 901-99-00025	
		DPN:	
ADO 3.a	TUBES AND FILTERS FOR RPS (NO RPS CARD)	MPN: 999-99-00503	
		DPN:	
ADO 4.1	Trio 20 SCALE CARD 2SCL WITH 230V POWER SUPPLY	MPN: 940-99-00015	OR
		DPN:	
ADO 4.2	Trio 20 SCALE CARD 6SCL WITH 230V POWER SUPPLY	MPN: 940-99-00016	OR
		DPN:	
ADO 4.3	Trio 20 SCALE CARD 2SCL WITH 115V POWER SUPPLY	MPN: 940-99-00017	OR
		DPN:	
ADO 4.4	Trio 20 SCALE CARD 6SCL WITH 115V POWER SUPPLY	MPN: 940-99-00018	
		DPN:	
ADO 5.1	CO2-POU-EN-MUR	MPN: 919-01-10002	OR
		DPN:	
ADO 5.2	CO2-POU-LYR-EN-MUR	MPN: 919-01-10003	OR
		DPN:	
ADO 5.3	CO2-POU-EN-NRO	MPN: 919-01-20002	
		DPN:	
ADO 6	AMMONIA-POU-MUN	MPN: 929-01-00002	
		DPN:	
ADO 7	LIGHT SENSOR-RLS-1-POU	MPN: 928-01-00001	
		DPN:	



9.3.7 CARDS

- Door Cards
- Main Container Cards

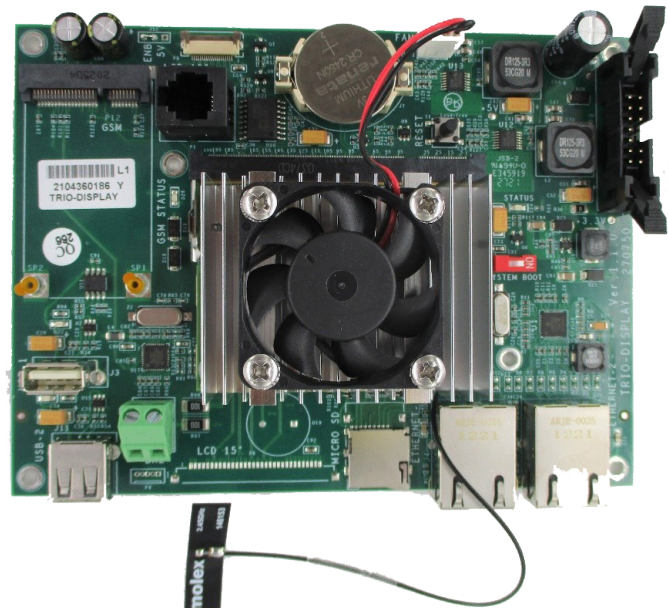

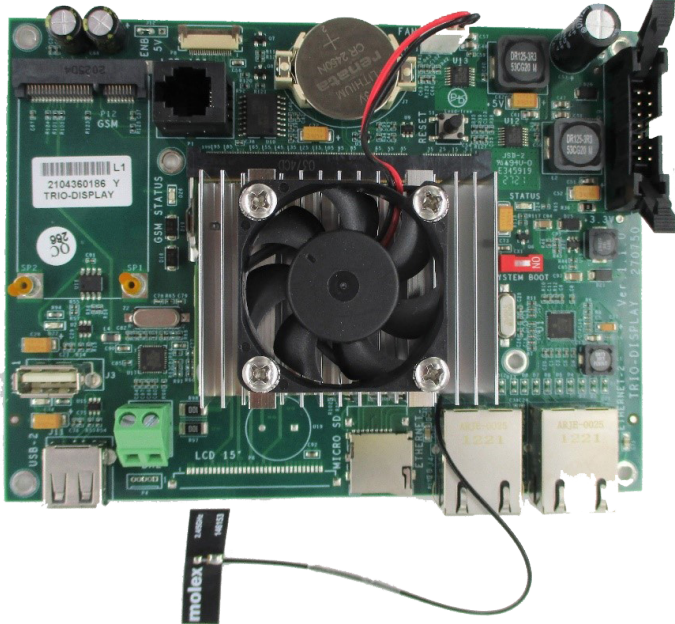
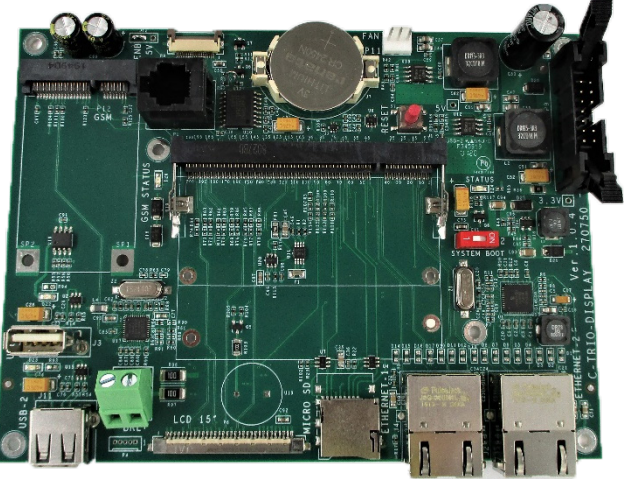
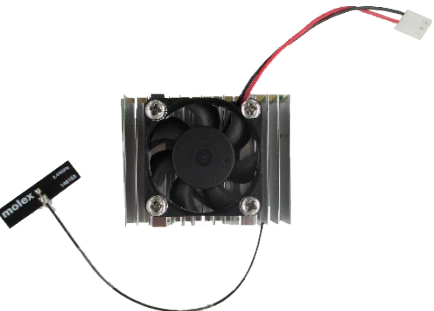
9.3.7.1 Door Cards

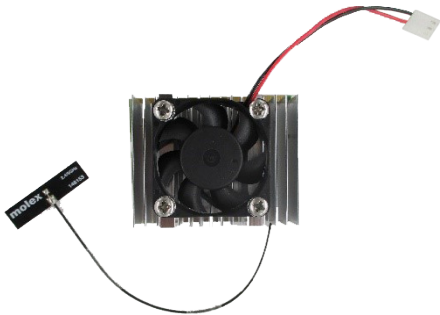
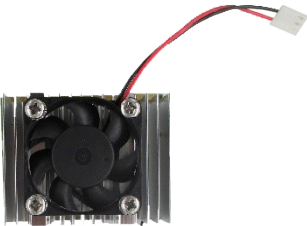
Card	Description	Munters Ordering Number
	<p>250061: LCD TFT 10.1' VT101C-KC17- B07A Vitek</p> <p>Or</p> <p>AM- 1024600O2TMQW- TA0H Ampire</p> <p>Or</p> <p>TWS2101RBTV20C APEX</p>	<p>940-99-00002</p>
	<p>140672: USB CABLE FOR Vitek\Ampire DISPLAY</p>	<p>940-99-00027</p>
	<p>Trio 20 -POU- DISPLAY CARD AND SOM VARISCITE CARD WITH HEATSINK AND FAN</p>	<p>940-99-00034</p>

Card	Description	Munters Ordering Number
	<p>Trio 20 -POU-CN- DISPLAY CARD AND SOM VARISCITE CARD WITH HEATSINK AND FAN</p> <p><u>Note: China Only</u></p>	<p>940-99-00032</p>
	<p>R-Trio-DISPLAY: MUNTERS ROTEM MIDDLE RANGE 2 PC</p>	<p>940-99-00004</p>
	<p>Trio 20 -POU- SOM VARISCITE CARD WITH HEATSINK AND FAN</p>	<p>940-99-00008</p>

Card	Description	Munters Ordering Number
	<p>Trio 20 -POU-CN-SOM VARISCITE CARD WITH HEATSINK AND FAN</p> <p><u>Note: China Only</u></p>	940-99-00044
	Trio 20 HEATSINK AND FAN FOR SOM CARD	940-99-00026
	204152: FAN FOR SOM CARD HEATSINK	940-99-00025
	491009: ANTENNA WI-FI MOLEX 1461530150 15cm CABLE, U.FL/I-PEX MHF	940-99-00035

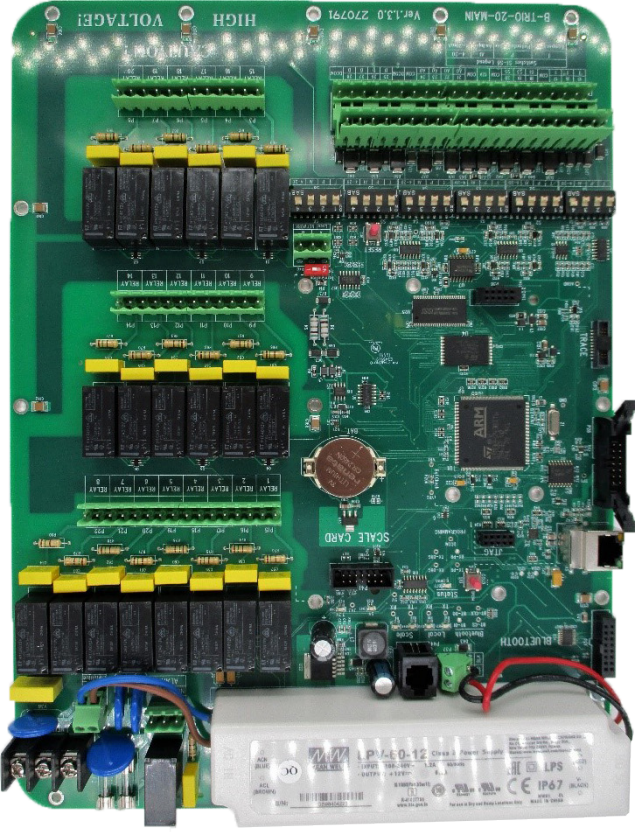
9.3.7.2 Main Container Cards

Card	Description	Munters Ordering Number
	<p>R-Trio-20-MAIN: MUNTERS ROTEM MIDDLE RANGE 2 CPU</p>	<p>940-99-00003</p>
	<p>370193: SWPS LPV-60-12 Mean Well 100-240V 12V 60W</p>	<p>900-99-00264</p>
	<p>STATIC PRESSURE SET - AC3G/SE/PL/Trio - POU</p>	<p>901-99-00025</p>

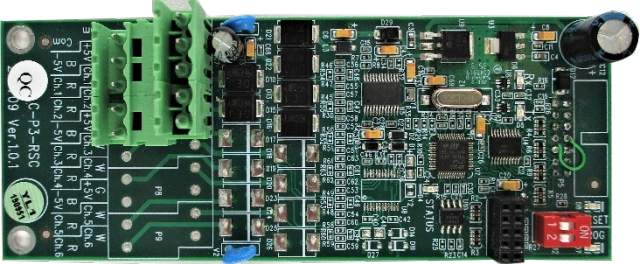
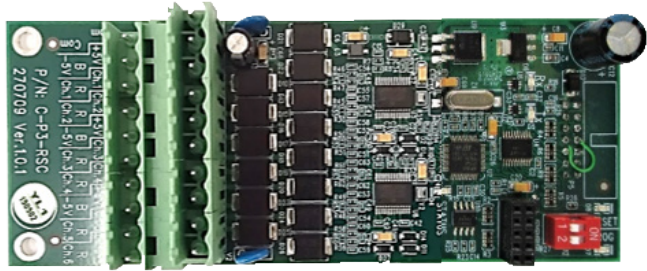
Card	Description	Munters Ordering Number
	<p>TUBES AND FILTERS FOR RPS (NO RPS CARD)</p>	<p>999-99-00503</p>
	<p>R-Trio-RSC-2: Trio 20 SCALE CARD 2CH</p>	<p>940-99-00013</p>
	<p>R-Trio-RSC-6: Trio 20 SCALE CARD 6CH</p>	<p>940-99-00014</p>

10 Appendix C: TRIO Expansion

- Introduction
- Expansion 10
- Expansion 20
- Mapping Devices in Expansion
- Expansion Specifications
- Expansion Spare Parts

10.1 Introduction

- Observe all the safety rules given in Precautions, page 10.
- Install the unit according to the instructions given in Unit Installation, page 20.

10.2 Expansion 10

- Expansion Layout
- TRIO to TRIO 10 Expansion Wiring
- High Voltage Relays
- Power

10.2.1 EXPANSION LAYOUT

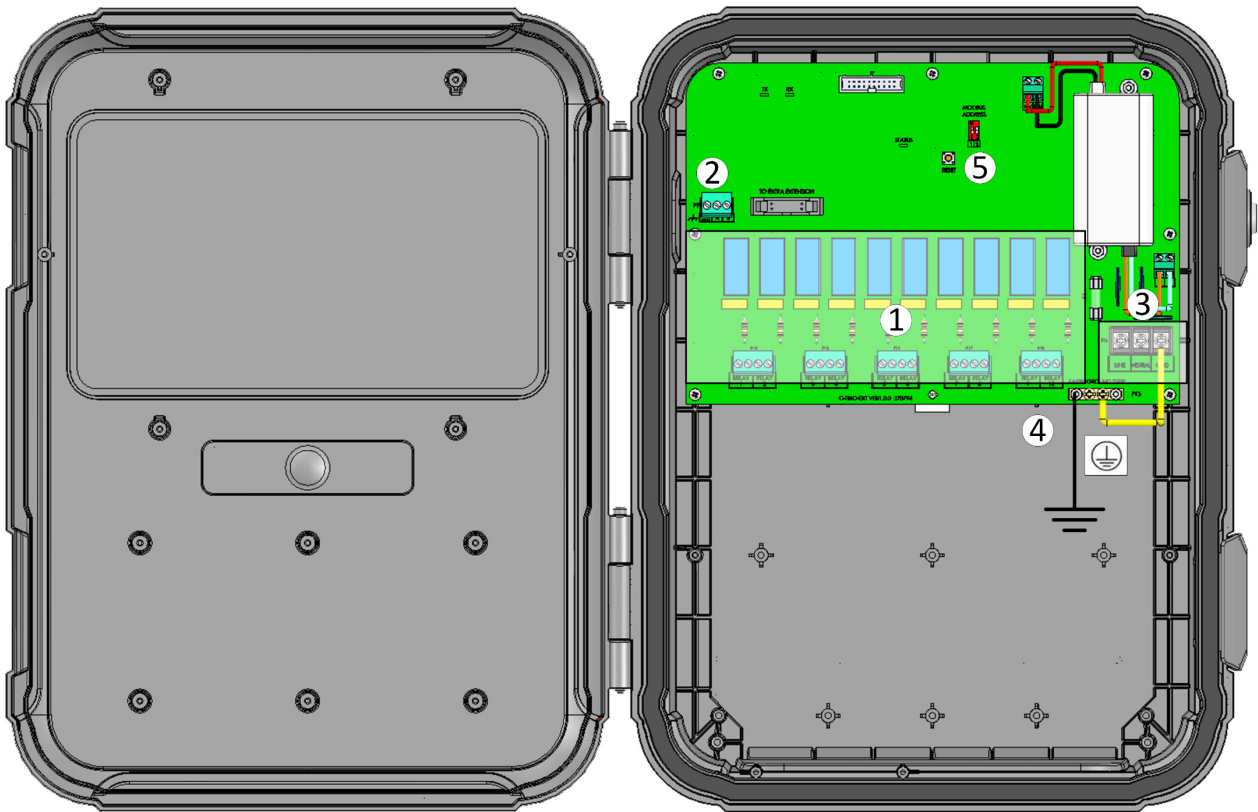

Figure 49: Board layout

1	10 relays
2	RS-485 ports
3	Power ports
4	Ground strip
5	Address dipswitch (refer to Address, page 145)

10.2.2 TRIO TO TRIO 10 EXPANSION WIRING

Connecting the Trio to its Expansion Unit consists of three steps:

- Wiring
- Address
- Restart

10.2.2.1 Wiring

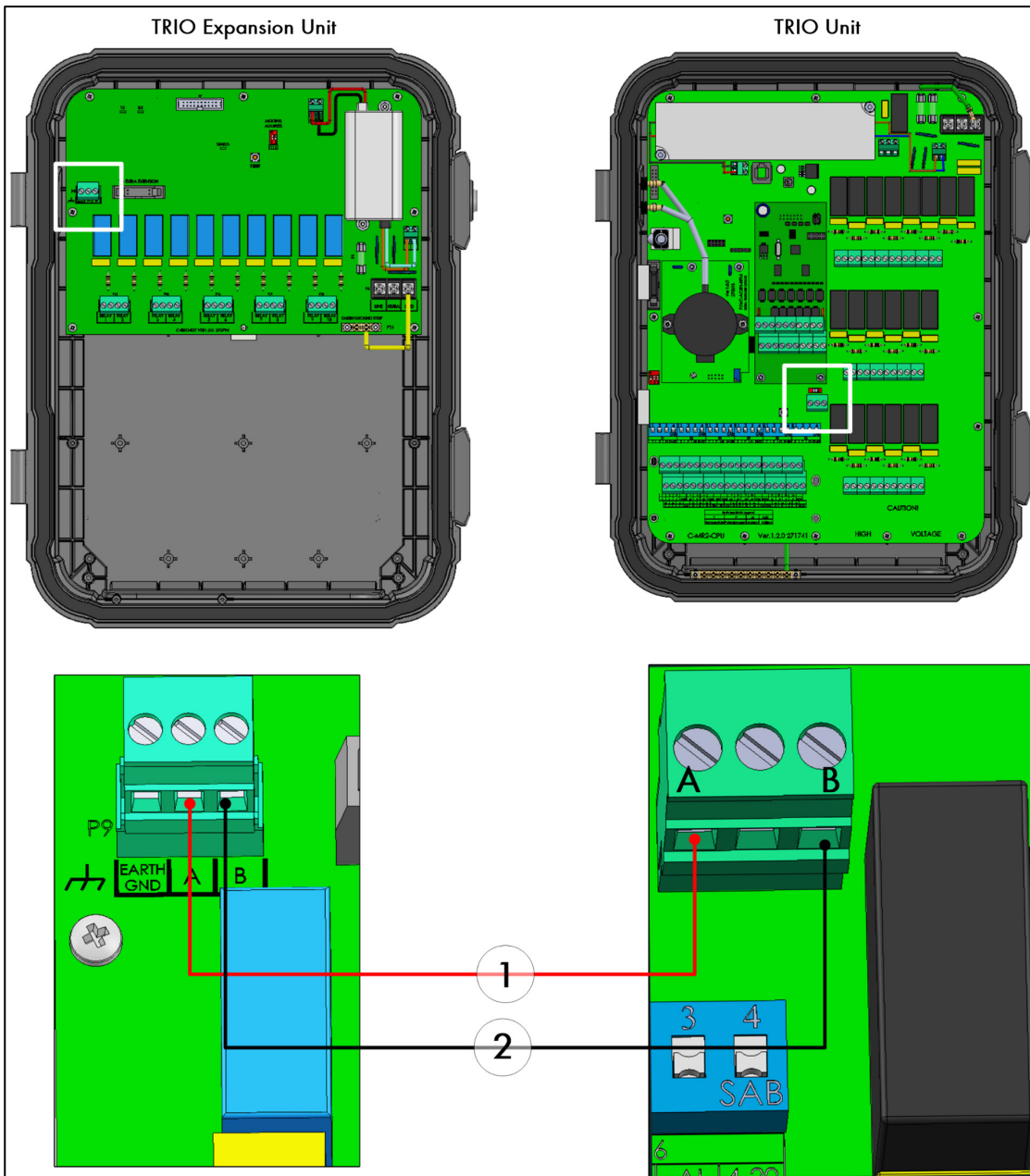

Figure 50: Wiring diagram

- The cable between the controller and the expansion unit should be a 4 wire twisted shielded cable (22 or 24 AWG).
- 1 – red wire
- 2 – black wire

10.2.2.2 Address

The Trio can support one expansion unit. Verify that both dipswitches in the Modbus Address are set to ON.

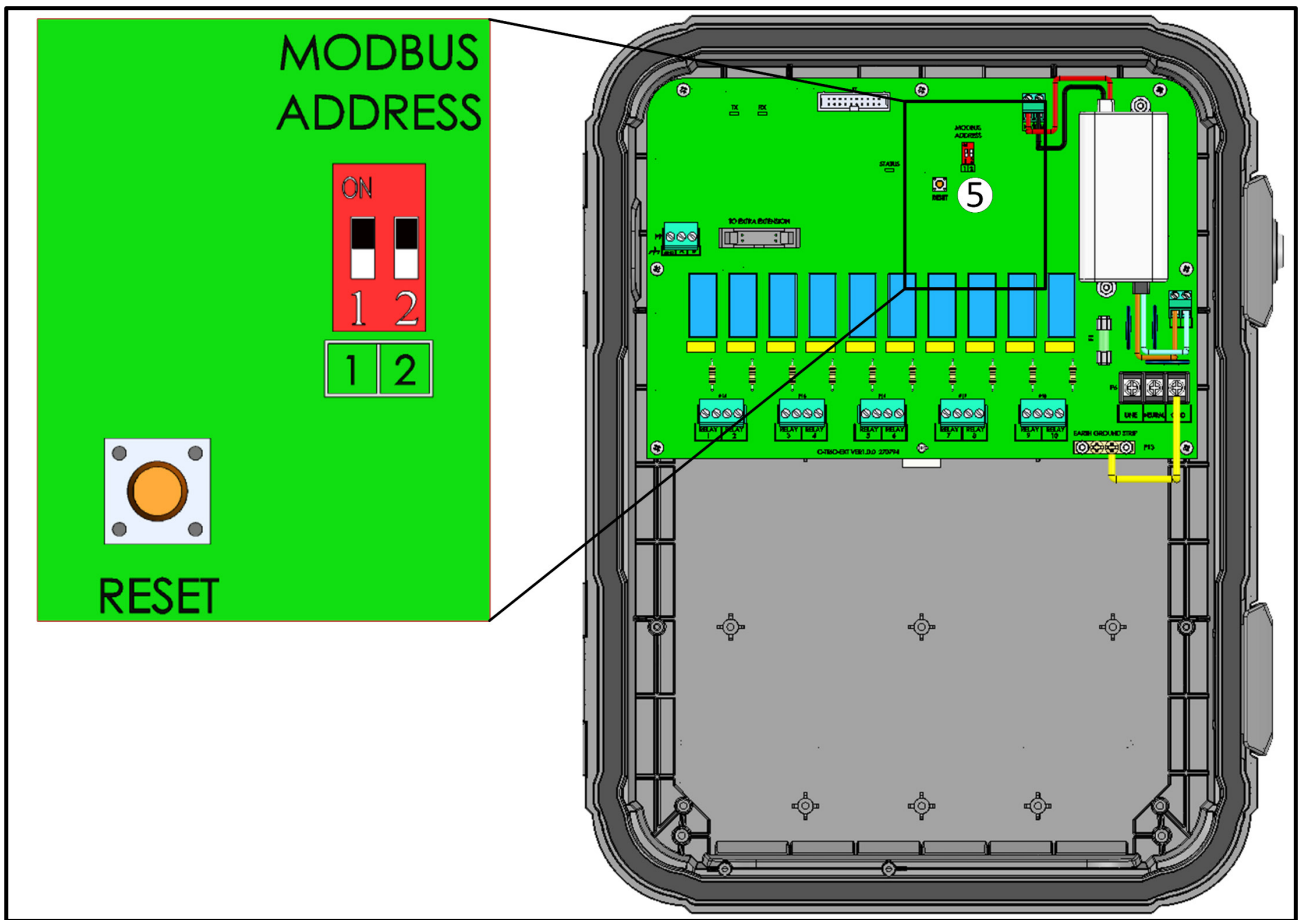

Figure 51: Expansion Address

10.2.2.3 Restart

After connecting the units and verifying the Modbus address, reset the factory settings.

1. Go to System > General Settings > .

2. Click .

3. Follow the on-line instructions. You have the option of backing up the settings. Refer to the User Manual for more information.

10.2.3 HIGH VOLTAGE RELAYS

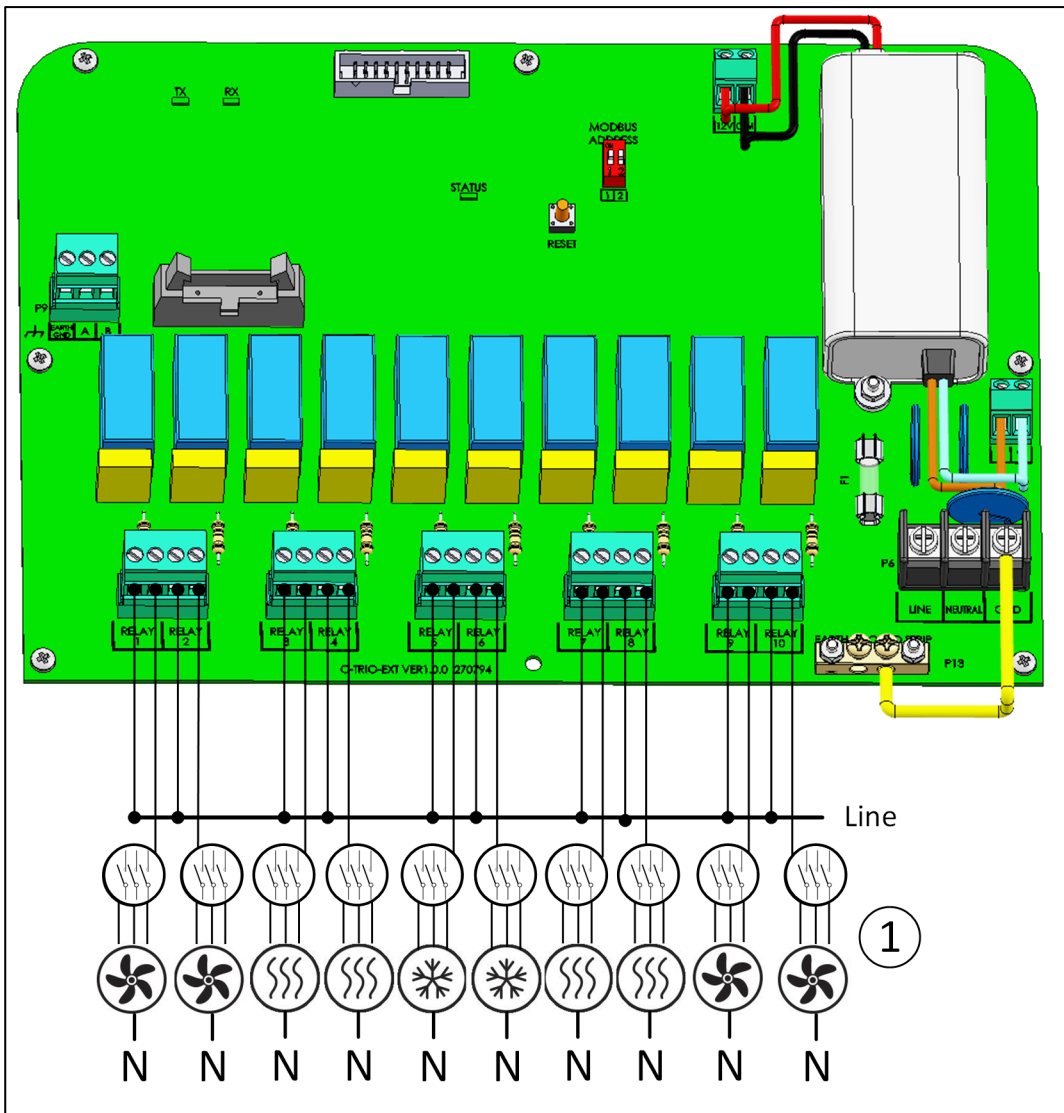

Figure 52: High voltage devices (examples)

1	Example of devices
---	--------------------

NOTE The relays control motors and heating devices via contactors, not directly.

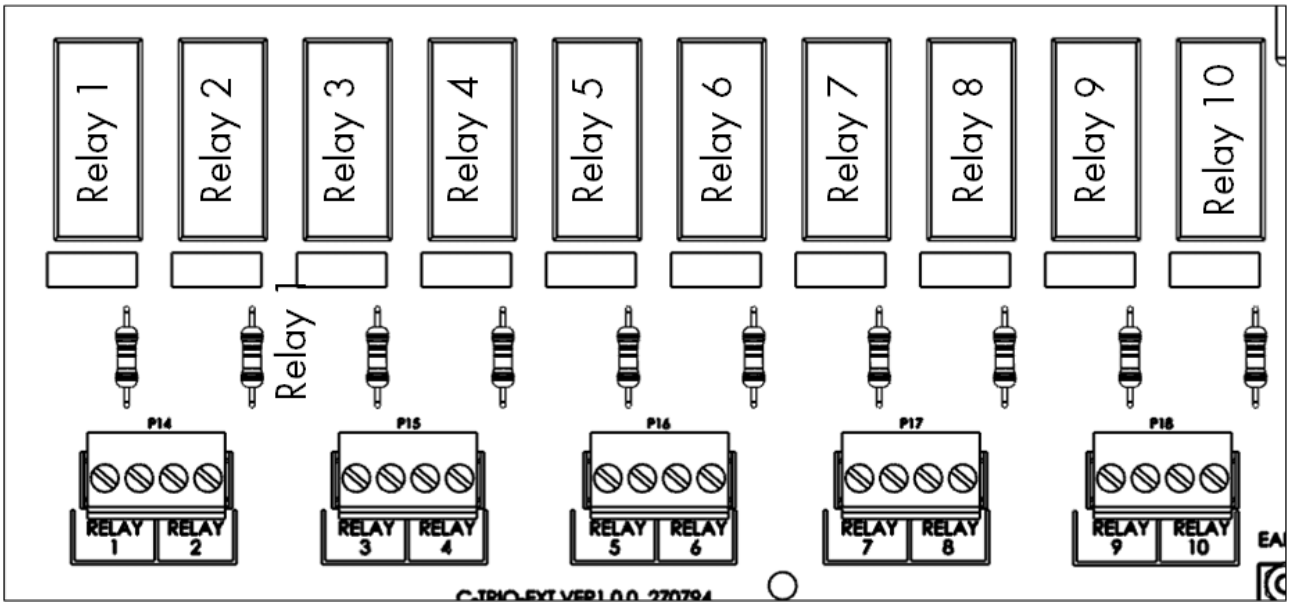

Figure 53: Relay and port numbering

10.2.4 POWER

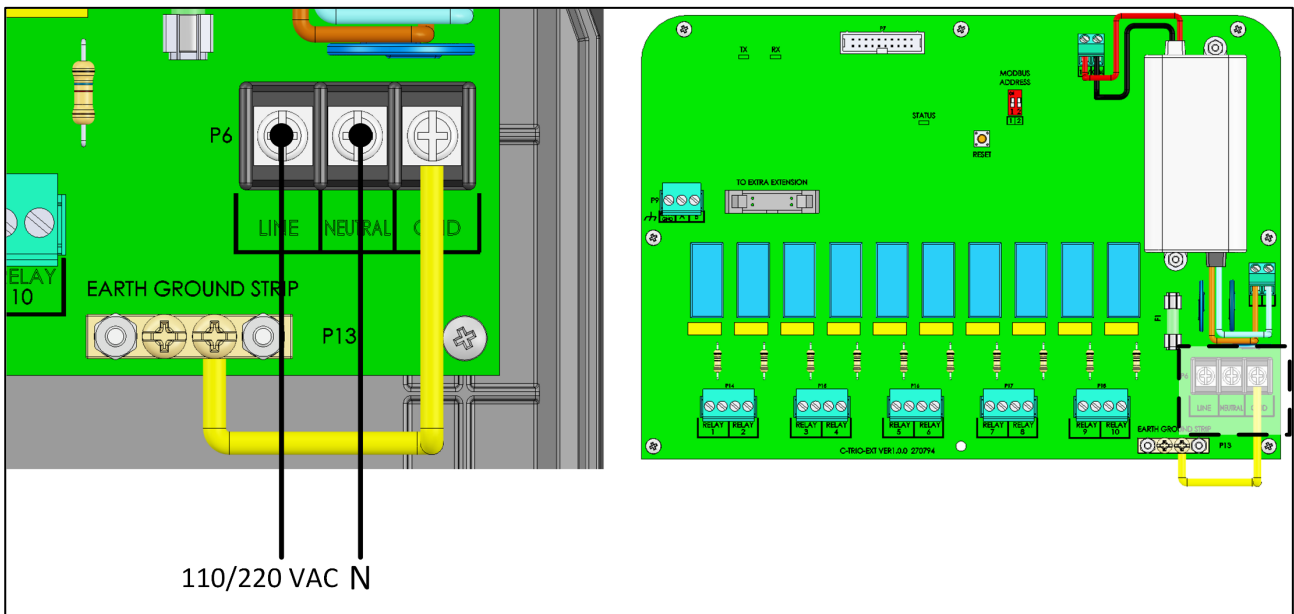

Figure 54: Power ports

10.3 Expansion 20

- Expansion Layout
- Expansion Wiring Diagrams
- High Voltage Relays
- Power

10.3.1 EXPANSION LAYOUT

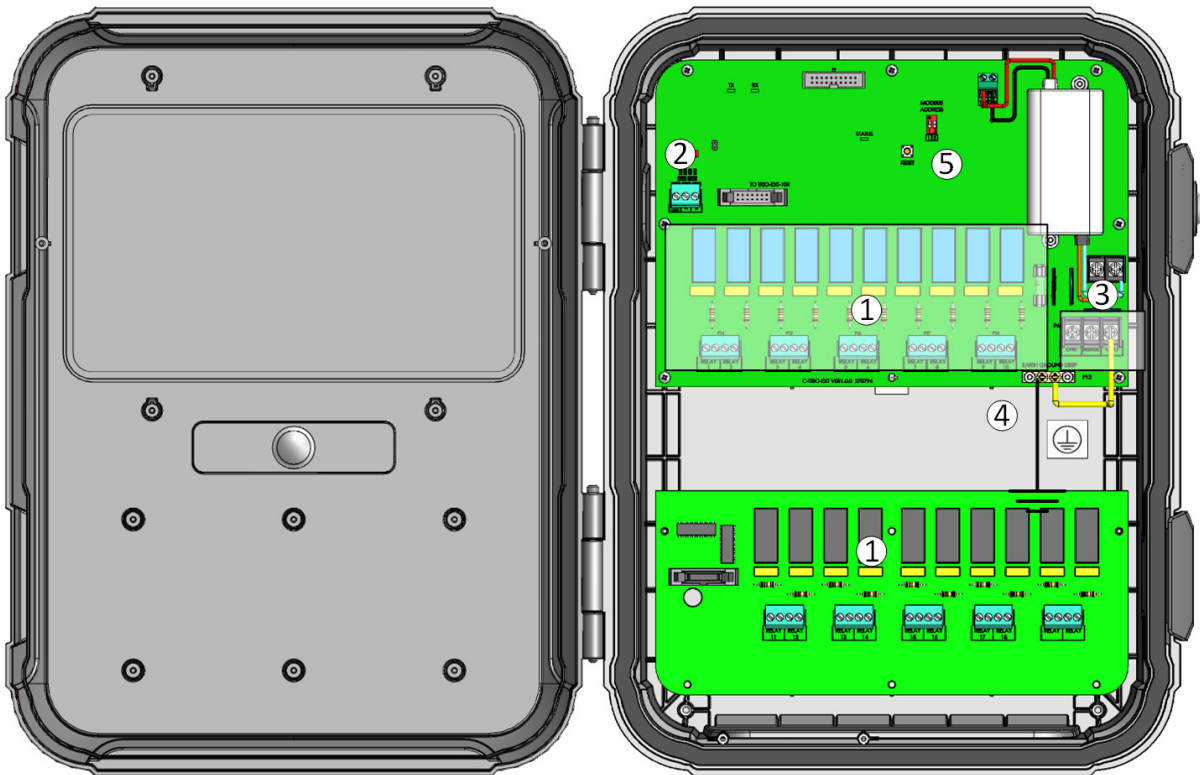

Figure 55: Board layout

1	20 relays
2	RS-485 ports
3	Power ports
4	Ground strip
5	Address dipswitch (refer to Address, page 145)

10.3.2 EXPANSION WIRING DIAGRAMS

Connecting the Trio to its Expansion Unit consists of three steps:

- Wiring
- Address
- Restart

10.3.2.1 Wiring

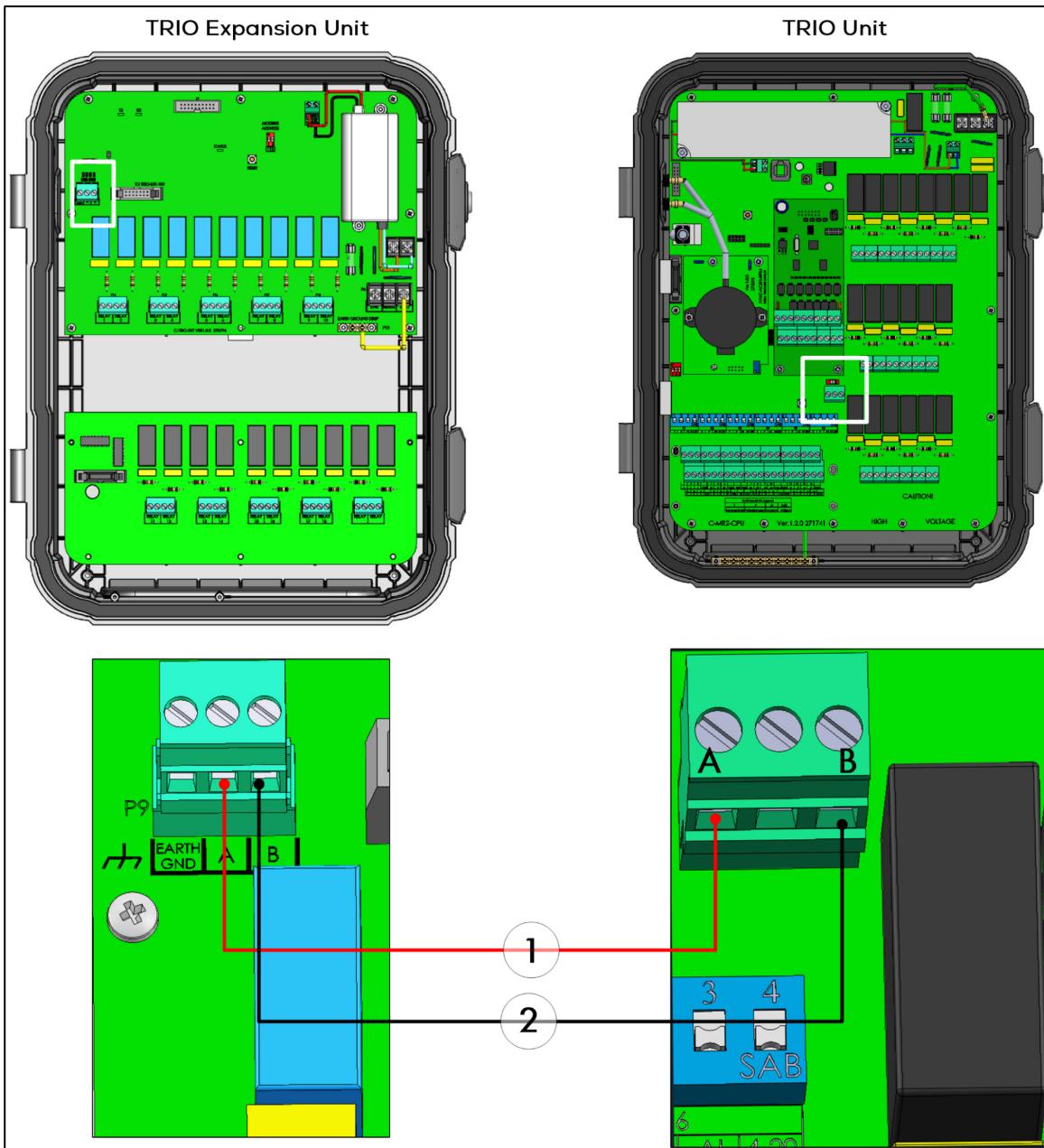

Figure 56: Wiring diagram

- The cable between the controller and the expansion unit should be a 4 wire twisted shielded cable (22 or 24 AWG).
- 1 – red wire
- 2 – black wire

10.3.2.2 Address

The Trio can support one expansion unit. Verify that both dipswitches in the Modbus Address are set to ON.

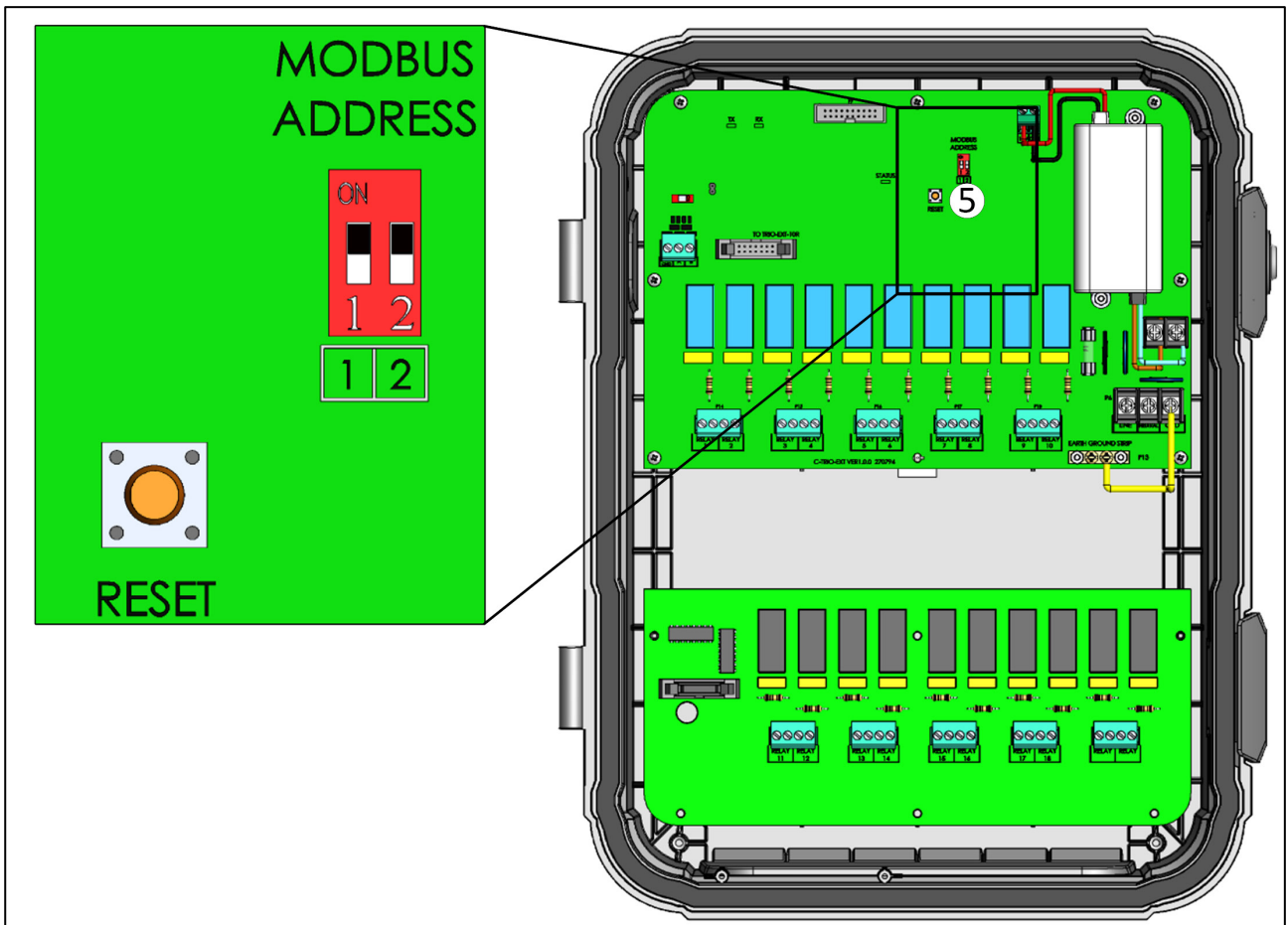

Figure 57: Expansion Address

10.3.2.3 Restart

After connecting the units and verifying the Modbus address, reset the factory settings.

1. Go to System > General Settings > .

2. Click .

3. Follow the on-line instructions. You have the option of backing up the settings. Refer to the User Manual for more information.

10.3.3 HIGH VOLTAGE RELAYS

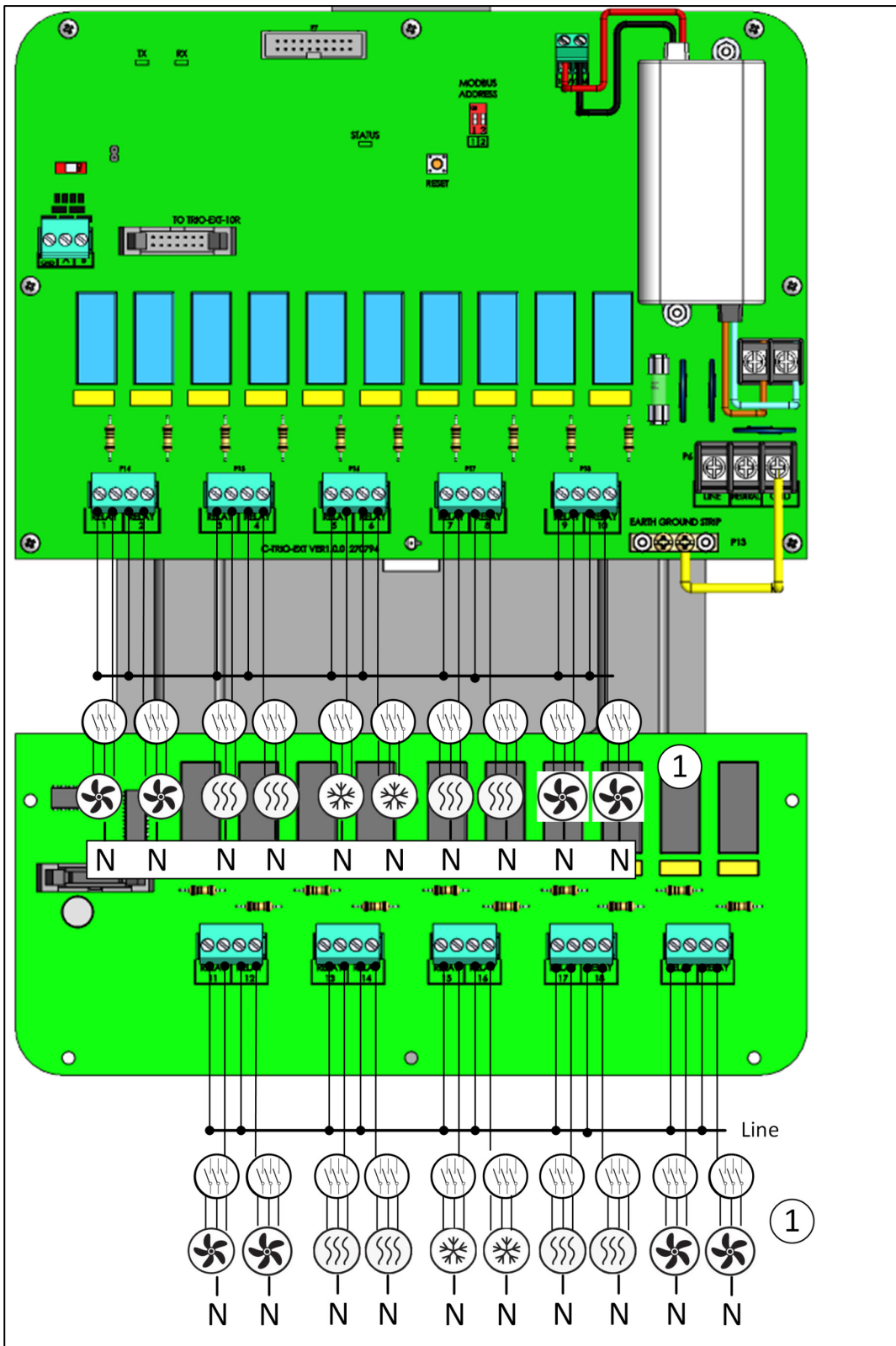
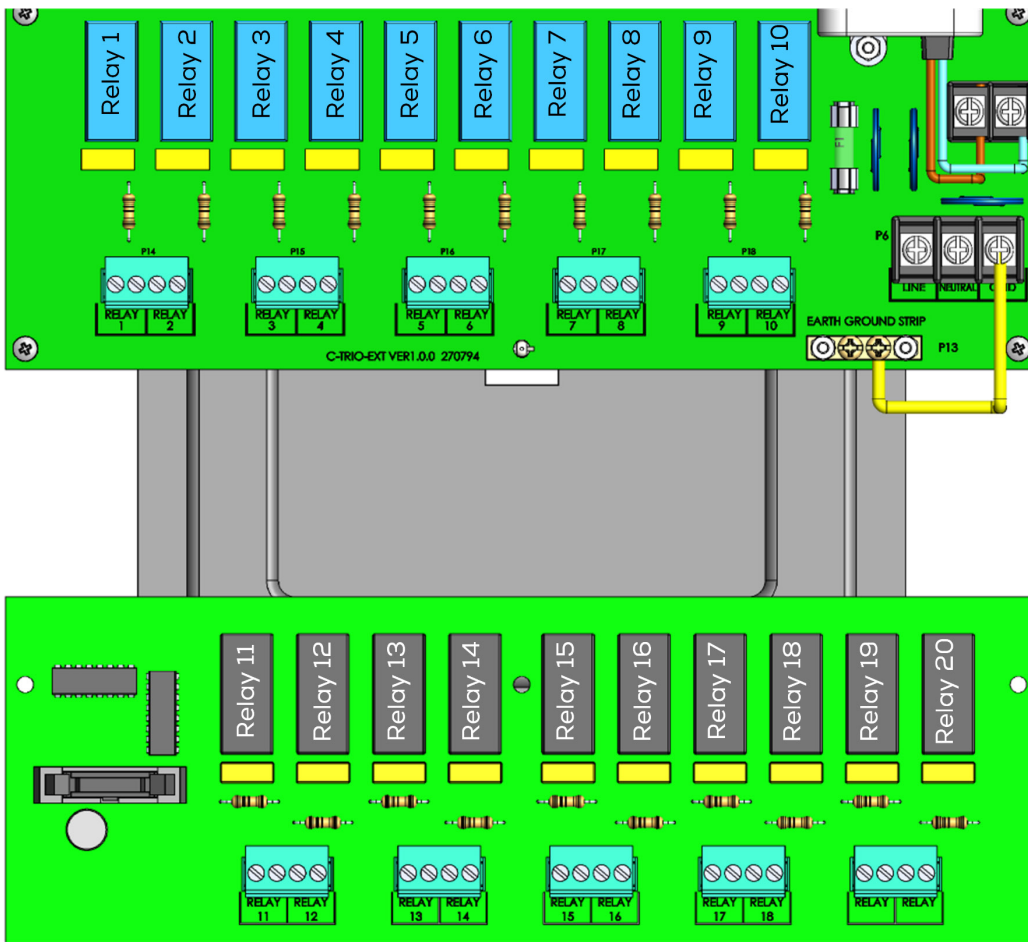

Figure 58: High voltage devices (examples)

1	Example of devices
---	--------------------

NOTE The relays control motors and heating devices via contactors, not directly.



Relay 1

Figure 59: Relay and port numbering

10.3.4 POWER

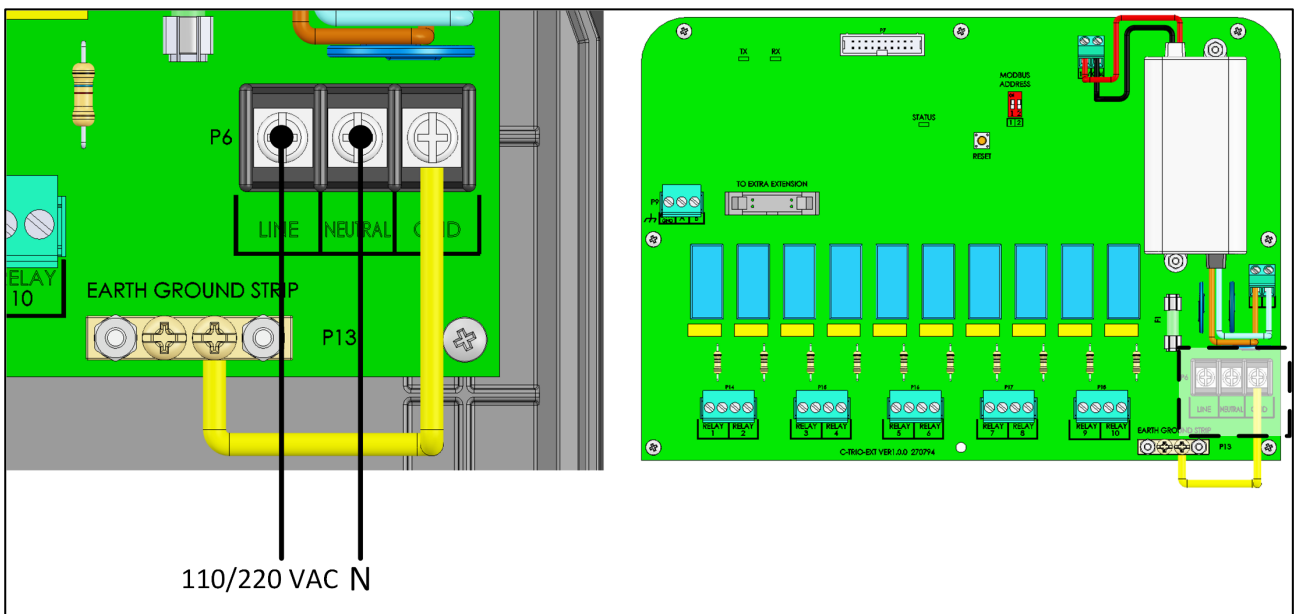

Figure 60: Power ports

10.4 Mapping Devices in Expansion

- Install and wire the Expansion unit to the TRIO and to the external devices before beginning.

- After wiring the Expansion unit to TRIO, go to System > General Settings > Info 

Reset Factory Settings

and click **Reset Factory Settings**. Follow the online instructions. TRIO will not recognize the Expansion until this step is performed.

After wiring devices to the TRIO Expansion Unit, each device must be mapped and then defined. Mapping and defining devices enables the system software to control each device's functionality.

CAUTION Mapping *MUST* match the physical wiring! An error message appears if the physical device is not wired to the relay or port as defined on the mapping screen.

To map the devices:

1. Go to System > Device and Sensors.

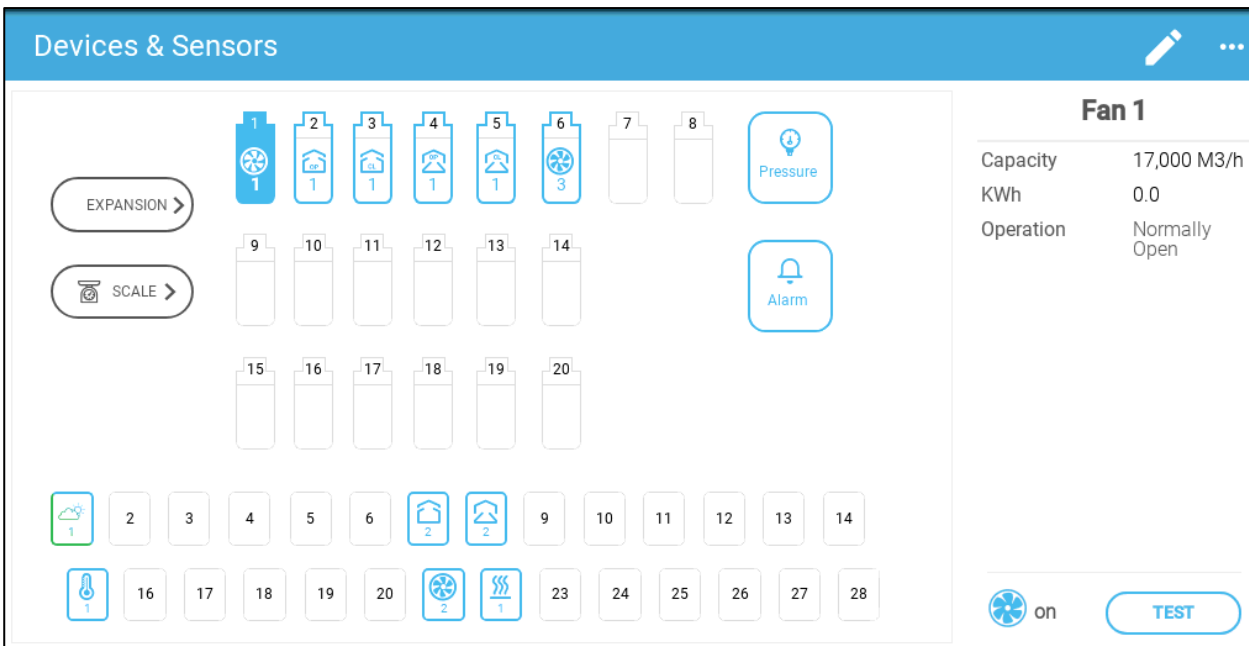

The screenshot shows the 'Devices & Sensors' configuration screen. It features a grid of 28 numbered slots. The first eight slots are grouped under an 'EXPANSION' button, and the next six slots are under a 'SCALE' button. Slot 1 is highlighted with a blue border and contains a fan icon. To the right of the grid, there are 'Pressure' and 'Alarm' status indicators. On the far right, a panel for 'Fan 1' displays its specifications: Capacity (17,000 M3/h), KWh (0.0), and Operation (Normally Open). At the bottom right, there is a fan icon with the text 'on' and a 'TEST' button.

2. Click Expansion.

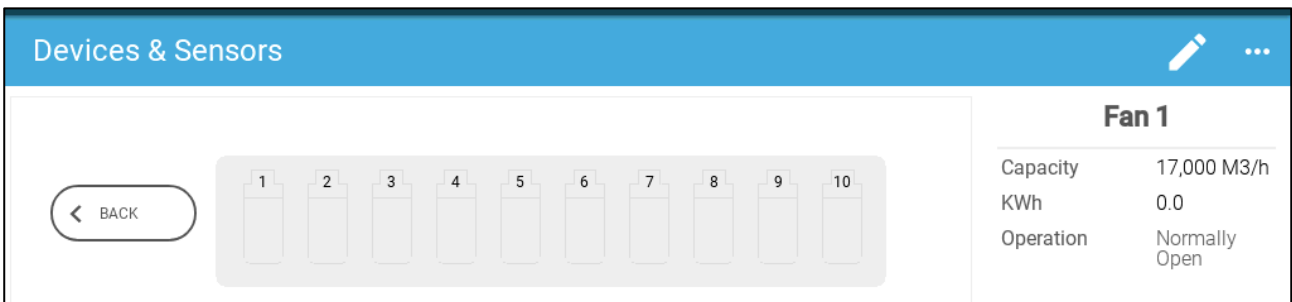





This screenshot shows the same 'Devices & Sensors' screen after the 'EXPANSION' button has been clicked. The 'EXPANSION' button is now highlighted, and the grid of 28 slots is dimmed. A 'BACK' button is visible on the left side of the grid. The 'Fan 1' details panel on the right remains unchanged, showing Capacity (17,000 M3/h), KWh (0.0), and Operation (Normally Open).

3. Map the devices as detailed in the TRIO manual. (refer to Using the Mapping Screen, page 70) for more information.

10.5 Expansion Specifications





- Expansion 10 Specifications
- Expansion 20 Specifications
- Expansion Specification Details

10.5.1 EXPANSION 10 SPECIFICATIONS

Parameter	Specifications
Input Power Voltage	115/230 VAC, 50/60 Hz
Input AC Power	0.2A
Maximum number of relays operating simultaneously	10
<i>Note: Running relays at the above current levels provides between 50,000 – 100,000 switching operations.</i>	
Communication	RS-485: 115 Kbps, 8 bit, even parity
Operating Temperature Range	-10° to +50° C (+14° to +125° F)
Storage Temperature Range	-20° to +80° C (-4° to +176° F)
Environmental Specifications	<ul style="list-style-type: none"> • Altitude: -400 m to 2000 m • Relative Humidity: 20% - 90% • Main supply voltage fluctuation up to +10 - 20% • Overvoltage category II
Enclosure	Water and dust tight Indoor use only
Dimensions (H/W/D)	403 x 324 x 141 mm/16 x 13 x 5.6 inches
Fuses	Fuse F2 on PS card: 3.15A, 250V
Certification	   

10.5.2 EXPANSION 20 SPECIFICATIONS

Parameter	Specifications
Input Power Voltage	115/230 VAC, 50/60 Hz
Input AC Power	500 mA
Maximum number of relays operating simultaneously	15
<i>Note: Running relays at the above current levels provides between 50,000 – 100,000 switching operations.</i>	
Communication	RS-485: 115 Kbps, 8 bit, even parity
Operating Temperature Range	-10° to +50° C (+14° to +125° F)

Parameter	Specifications
Storage Temperature Range	-20° to +80° C (-4° to +176° F)
Environmental Specifications	<ul style="list-style-type: none"> • Altitude: -400 m to 2000 m • Relative Humidity: 20% - 90% • Main supply voltage fluctuation up to +10 - 20% • Overvoltage category II • PD: 2
Enclosure	<ul style="list-style-type: none"> • IP: 52 • Indoor use only
Dimensions (H/W/D)	403 x 324 x 141 mm/16 x 13 x 5.6 inches
Fuses	Fuse F2 on PS card: 3.15A, 250V
Certification	   

10.5.3 EXPANSION SPECIFICATION DETAILS

- **Disconnection device/overcurrent protection:** In the building installation, use a certified 2-pole circuit breaker rated 10A, certified in accordance with the IEC standard 60947-2 (in the US and Canada use a Listed Branch Circuit protective circuit breaker). This step is required to provide overcurrent protection and mains disconnection. The circuit breaker must be easily accessible and marked as the controller disconnect device.
- **Main Supply Voltage:** Permanently connect the controller to the mains in accordance with the relevant national code. Provide fixed wiring inside a flexible conduit. Relays must be suitably protected against overcurrent, using a circuit breaker rated at 10A.
- **Keep the units closed and locked.** Only authorized personnel should open and close the units.

10.6 Expansion Spare Parts

- Preliminary Information
- Trio Expansion 10 Spare Parts
- Trio Expansion 20 Spare Parts
- Additional OptionsCards

10.6.1 PRELIMINARY INFORMATION

	TRIO EXP 10	TRIO EXP 20
Container	A	C
Main Container Cards	B	D
Cables and Harnesses	N/A	E
MPN	Munters Part Number	
DPN	Distributor Part Number	

10.6.2 TRIO EXPANSION 10 SPARE PARTS

- Trio Expansion 10 Container Spare Parts
- Trio 20 Main Container Spare Parts

10.6.2.1 Trio Expansion 10 Container Spare Parts



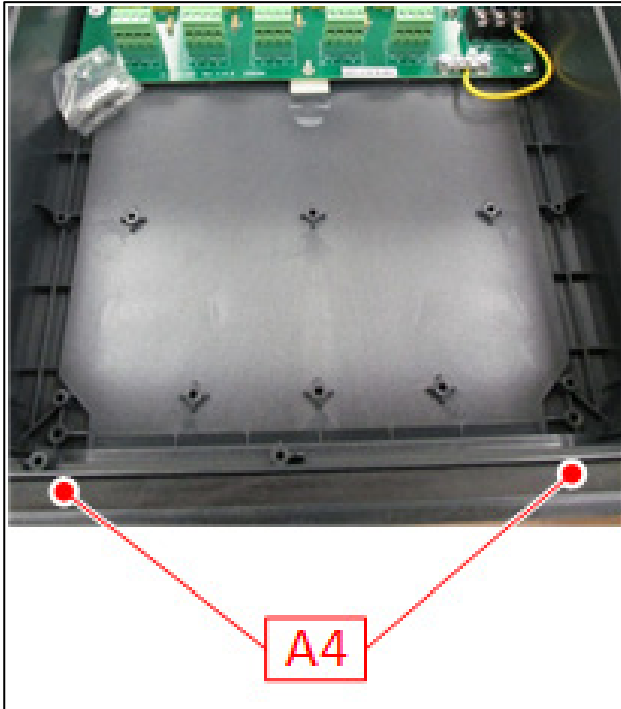

ID No.	Description	Order Catalog Number	Note
A1.1	TRIO FRONT DOOR EXP PLASTIC PART V1.0.0 (SP: 207129)	MPN: 940-99-00028 DPN:	
A1.2	TRIO-20 PLASTIC BOX BASE (SP: 207124)	MPN: 940-99-00112 DPN:	
A1.3	TRIO HINGE PLASTIC PIN V1.0.0 (SP-207128)	MPN: 940-99-00019 DPN:	
A2.1	TRIO-20 PANEL PLASTIC PART BLUE LOGO MUNTERS + PART BLUE	MPN: 940-99-00001 DPN:	OR
A2.2	TRIO PANEL PLASTIC PART RED RAL 3020 NO LOGO (SP-207138)	MPN: 940-99-00045 DPN:	
A3.1	GENERAL PLASTIC LATCH	MPN: 900-99-00216 DPN:	
A3.2	ONE/ONE PRO LATCH GENERAL LOCK PLASTIC PART + LOCK FOR LATCH	MPN: 900-99-00217 DPN:	
A4	MID-RANGE MAIN GASKET V1.0.0 (SP-207122)	MPN: 940-99-00021 DPN:	

10.6.2.2 Trio Expansion 10 Main Container Spare Parts

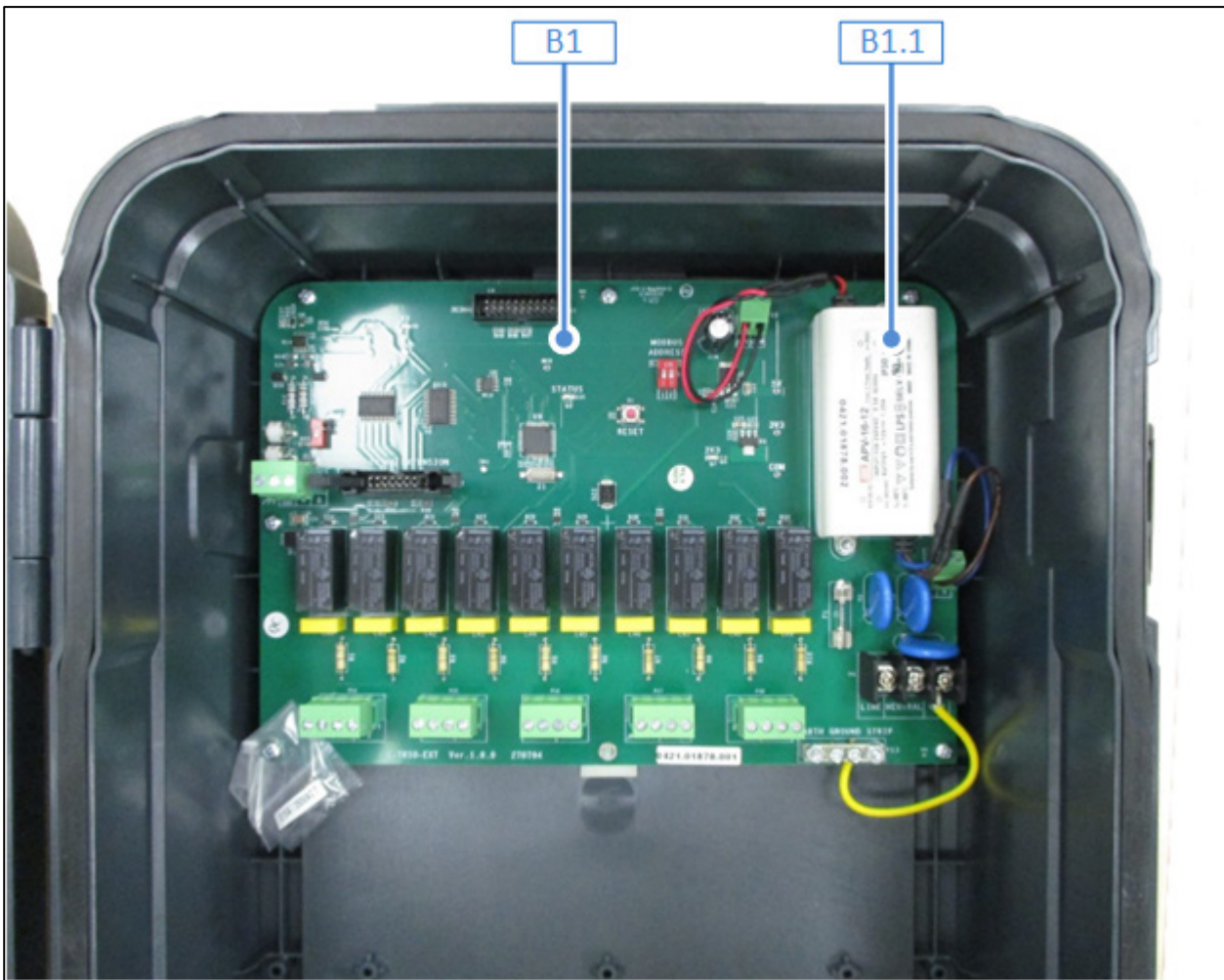

ID No.	Description	Order Catalog Number
B1	TRIO-EXP 10 CARD (SP: R-TRIO-EXP10)	MPN: 940-99-00029
		DPN:
B1.1	SWPS APV-16-12 Mean Well 115V/230V 12V 16W (SP: 370153)	MPN: 999-99-00338
		DPN:

10.6.3 TRIO EXPANSION 20 SPARE PARTS

- Trio Expansion 20 Container Spare Parts
- Trio Expansion 20 Main Container Spare Parts

10.6.3.1 Trio Expansion 20 Container Spare Parts

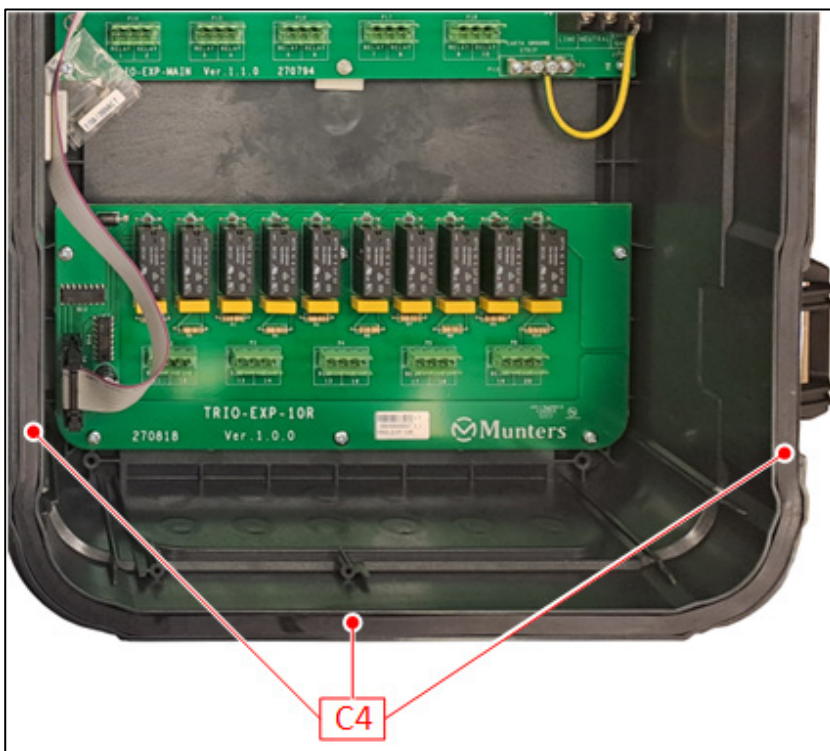

ID No.	Description	Order Catalog Number	Note
C1.1	TRIO FRONT DOOR EXP PLASTIC PART V1.0.0 (SP: 207129)	MPN: 940-99-00028	
		DPN:	
C1.2	TRIO-20 PLASTIC BOX BASE (SP: 207124)	MPN: 940-99-00112	
		DPN:	
C1.3	TRIO HINGE PLASTIC PIN V1.0.0 (SP-207128)	MPN: 940-99-00019	
		DPN:	
C2.1	TRIO-20 PANEL PLASTIC PART BLUE LOGO MUNTERS + PART BLUE	MPN: 940-99-00001	OR
		DPN:	
C2.2	TRIO PANEL PLASTIC PART RED RAL 3020 NO LOGO (SP-207138)	MPN: 940-99-00045	
		DPN:	
C3.1	GENERAL PLASTIC LATCH	MPN: 900-99-00216	
		DPN:	
C3.2	ONE/ONE PRO LATCH GENERAL LOCK PLASTIC PART + LOCK FOR LATCH	MPN: 900-99-00217	
		DPN:	
C4	MID-RANGE MAIN GASKET V1.0.0 (SP-207122)	MPN: 940-99-00021	
		DPN:	

10.6.3.2 Trio Expansion 20 Main Container Spare Parts

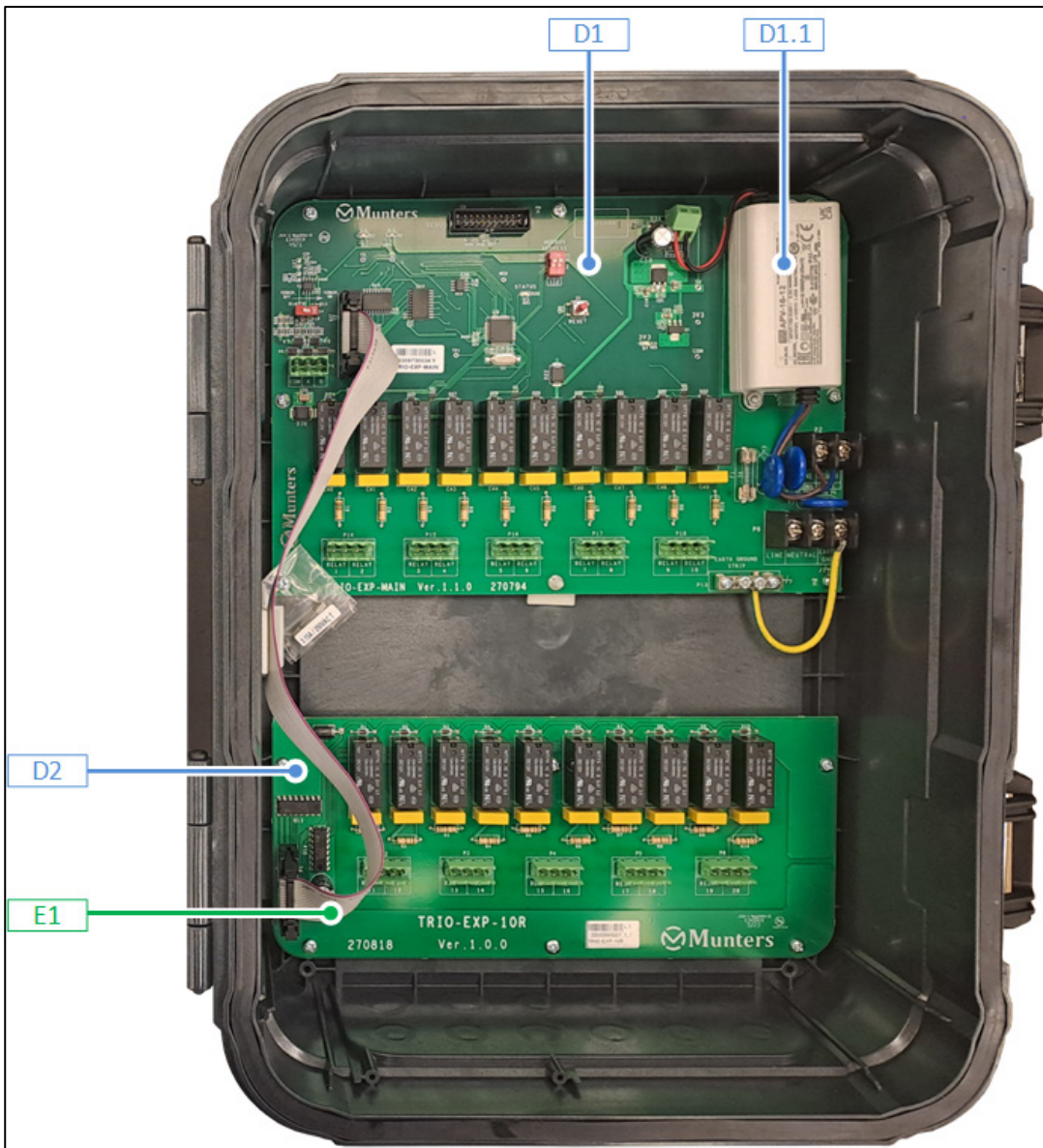



ID No.	Description	Order Catalog Number
D1	TRIO-EXP 10 CARD (SP: R-TRIO-EXP10)	MPN: 940-99-00029 DPN:
D1.1	SWPS APV-16-12 Mean Well 115V/230V 12V 16W (SP: 370153)	MPN: 999-99-00338 DPN:
D2	TRIO EXP 10 RELAY ADDIT CARD (TRIO-EXP-10R)	MPN: 940-99-00159 DPN:

ID No.	Description	Order Catalog Number
E1	FLAT FF14P 34cm (TRIO EXP)<F"D_F"D> (SP-141201)	MPN: 940-99-00168 • DPN:

10.6.4 ADDITIONAL OPTIONS

ID No.	Description	Order Catalog Number
ADO 1	Trio Expansion: 10 Relays To 20 Relays Upgrade Kit	MPN: 940-99-00169
		DPN:

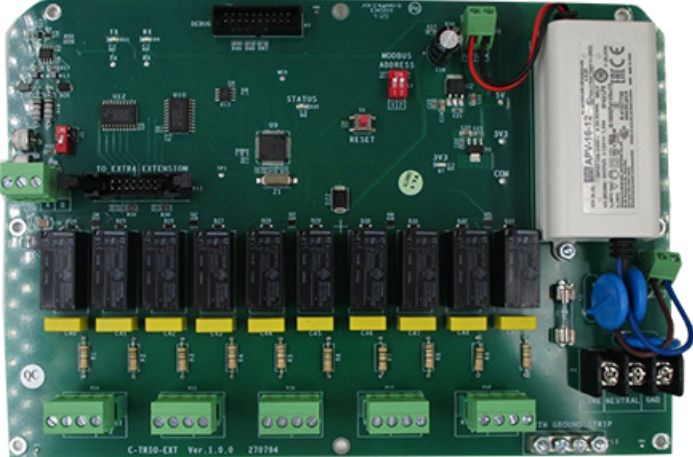
10.6.5 CARDS

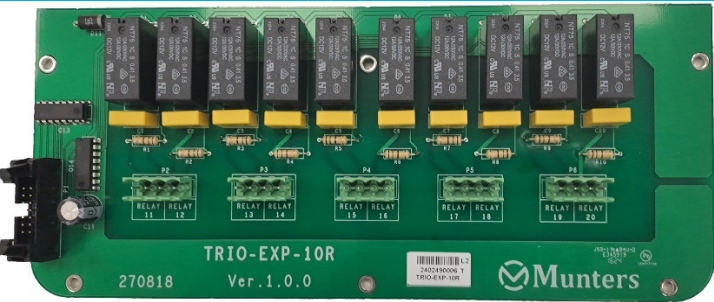
Card	Description	Munters Ordering Number
 <p>A green printed circuit board (PCB) for a Trio expansion. It features a central microcontroller, a status LED, a reset button, and a terminal block for power. The board is populated with various electronic components and has a 'TO EXTENSION' connector on the left side.</p>	R-TRIO-EXP10: TRIO EXP 10 CARD	940-99-00029
 <p>A white Mean Well APV-16-12 switching power supply. It has a blue AC input cable and a red/black DC output cable. The label provides technical specifications: 115V/230V input, 12V output, and 16W power.</p>	370153: SWPS APV-16-12 Mean Well 115V/230V 12V 16W	999-99-00338
 <p>A green PCB for a Trio expansion with 10 relays. It features 10 relay modules, each with a terminal block labeled 'RELAY RELAY'. The board is labeled 'TRIO-EXP-10R Ver. 1.0.0' and includes the Munters logo.</p>	R-TRIO-EXP- 10R: CARD EXP RLY ADDIT 10 TRIO	940-99-00159

11 Appendix D: Trio Cell Modem Installation

This document details how to install and configure a cell modem in a Trio unit lacking this device.

- Prerequisites
- Installation

11.1 Prerequisites

- Supported Devices
- Required Software
- Internet Access

11.1.1 SUPPORTED DEVICES

Trio Display Card Version 1.1.0 or above supports the modem.

- Order: 940-99-00049 Trio GLOBAL LTE CELL MODEM & EXTERNAL ANTENNA.
- For Trio Display Board versions 1.0 or lower, contact Customer Success.



Figure 61: SIM 940-99-00049 Front and Back

11.1.2 REQUIRED SOFTWARE

Trio cell modem requires the following software installations:

- Image Version 1.5. Consult with a Munters technician on how to install the image.
- Software Version 5.0 or higher. Upgrade this software via the Trio Software Upgrade screen.

11.1.3 INTERNET ACCESS

Trio has a priority system for internet access:

1. LAN connection
2. WIFI
3. Cell modem

If a LAN connection is available, Trio automatically connects to the web via the LAN only, even if the unit supports WIFI or a cell modem connection. If there is no LAN, Trio uses WIFI. Trio will only use the cell modem when the first two options are not available.

11.2 Installation

- Physical Installation
- Configuration

11.2.1 PHYSICAL INSTALLATION

- Modem and SIM Card
- Drilling

11.2.1.1 Modem and SIM Card

1. Locate the designated spot for the modem.

2. Insert the modem into the connector and secure it using the two screws supplied.

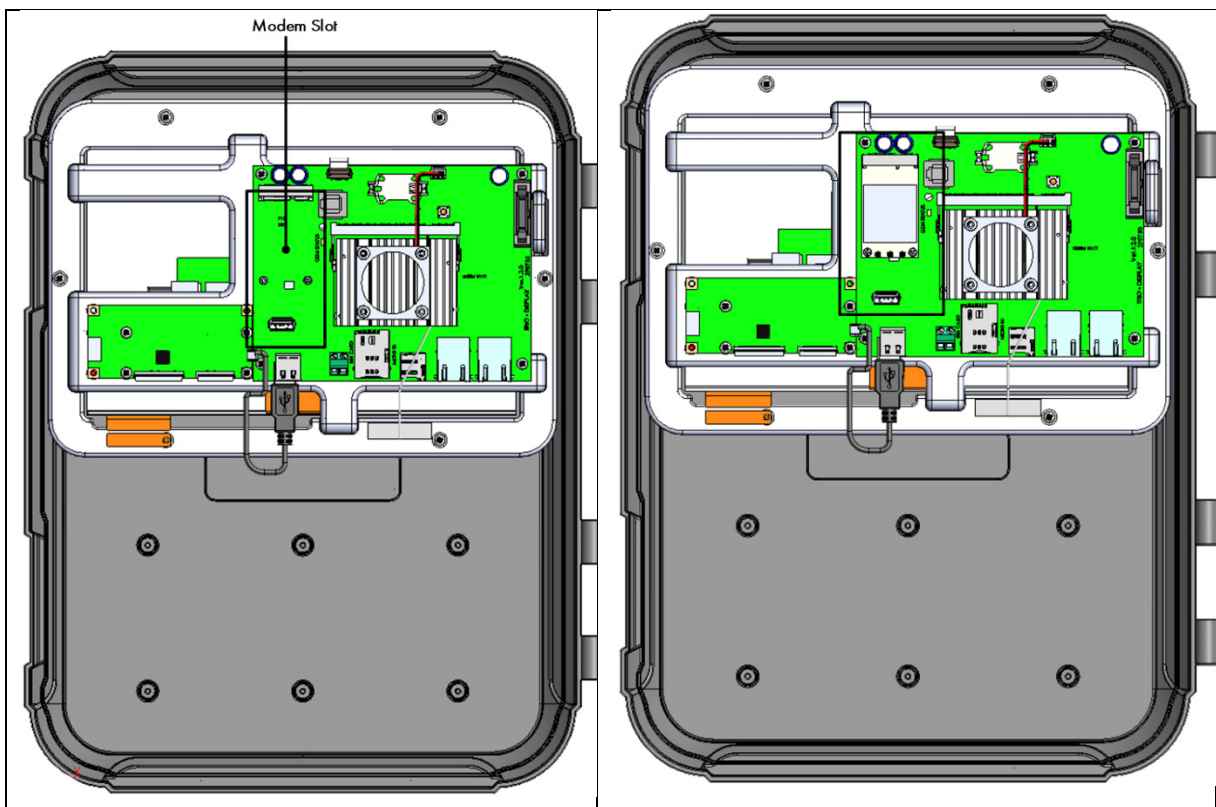

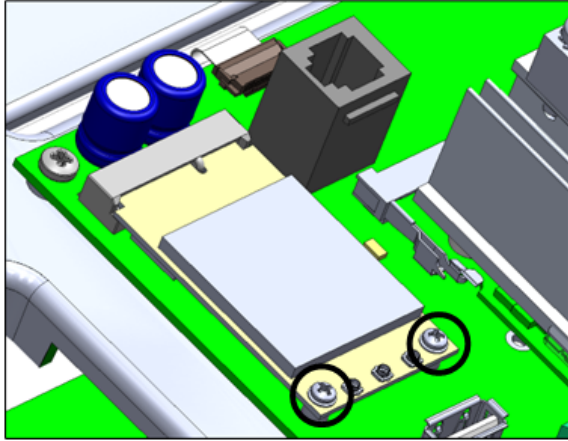

3. Insert the SIM card into the SIM port.

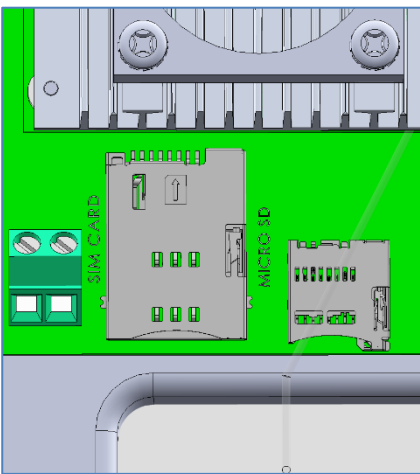

4. Gently press the cable connector onto the modem.

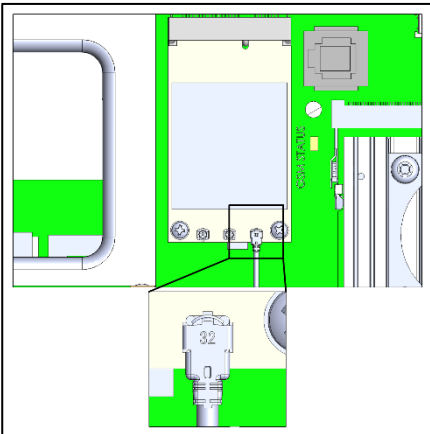

5. Thread the modem cable to the connector as shown below.

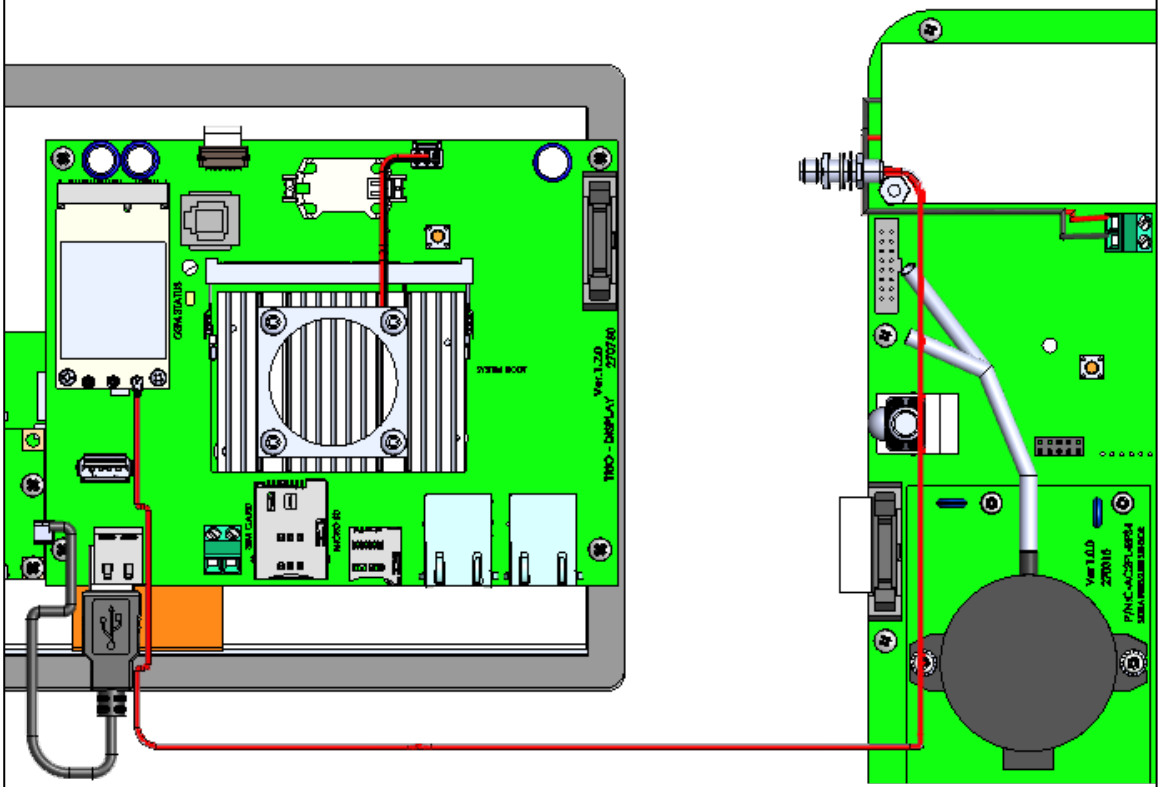
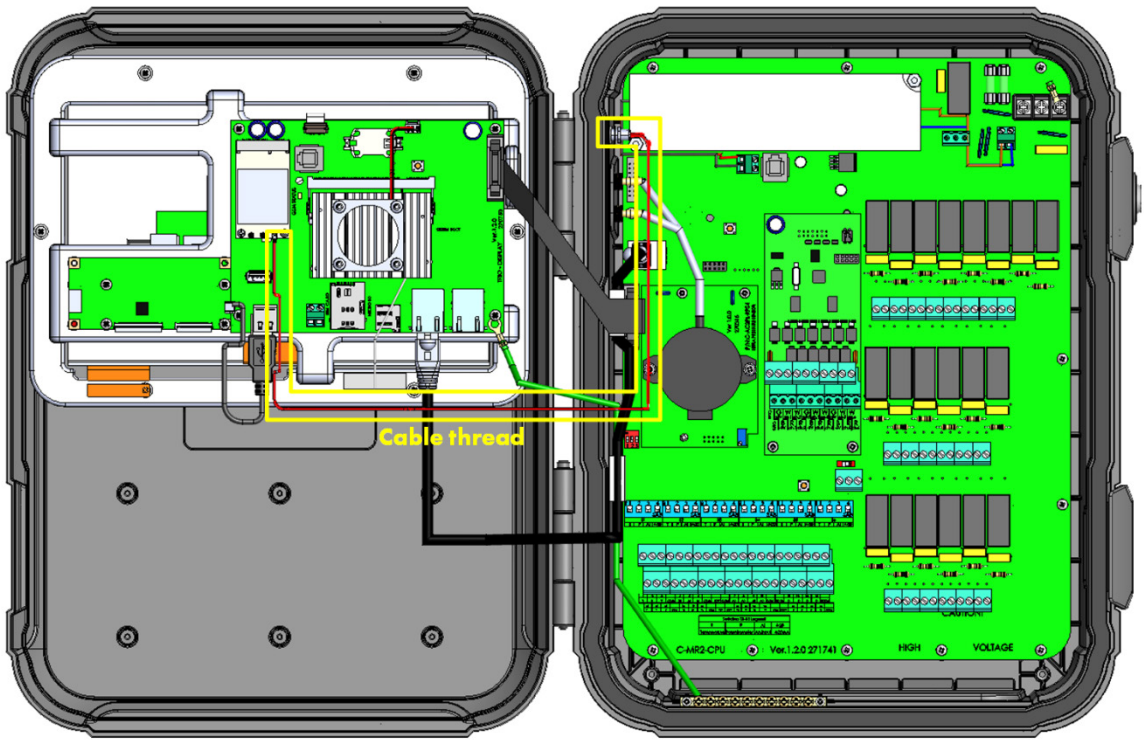

6. Remove the plug in the spot designated for the SMA connector.

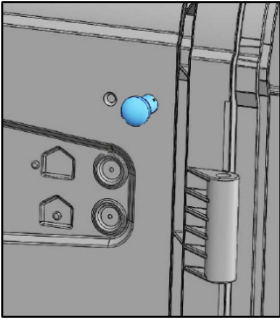

7. Remove the sealing cap and attach the antenna. (For older units, refer to the next section.)

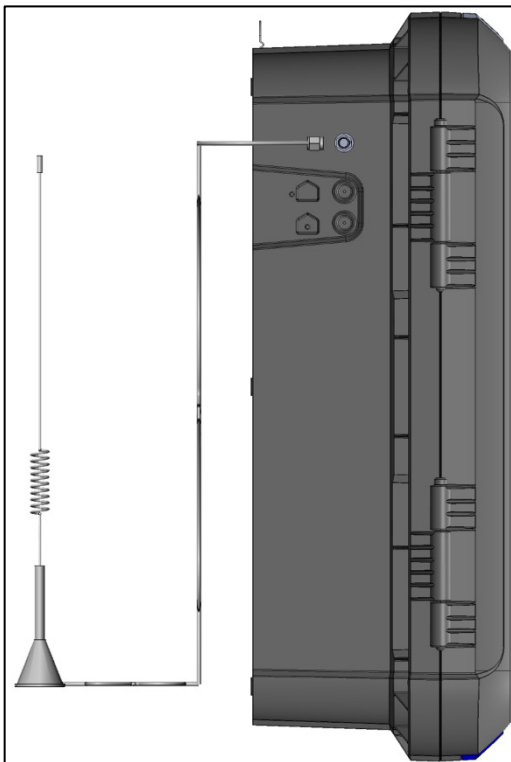

8. Secure the antenna using the brace provided.

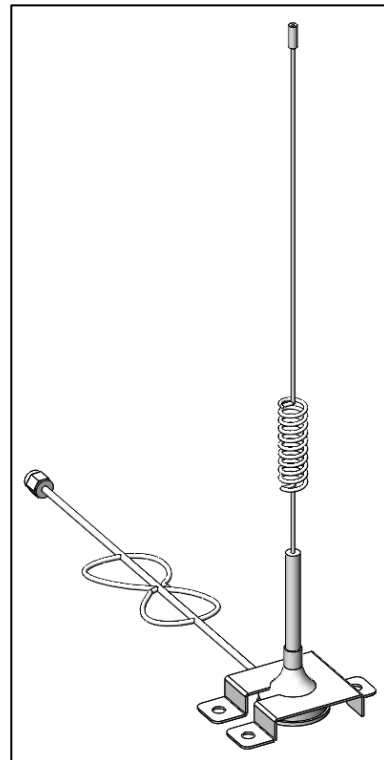

11.2.1.2 Drilling

In the event that the Trio unit was shipped before 08/2022, a hole must be drilled for the SMA connector.

1. Drill a 6.5-millimeter hole in the spot shown below.

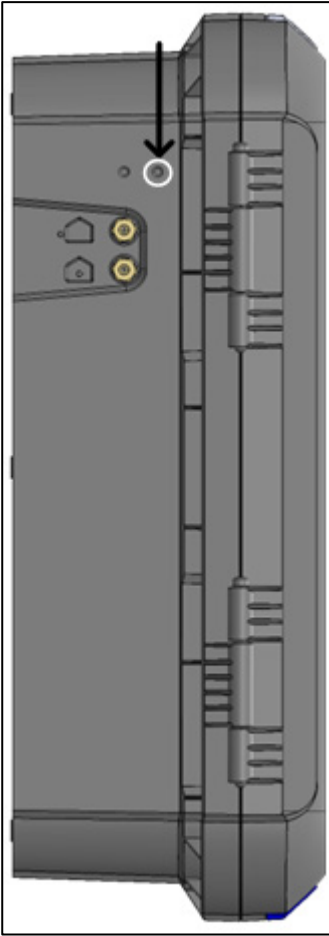

2. Insert and secure the SMA connector.

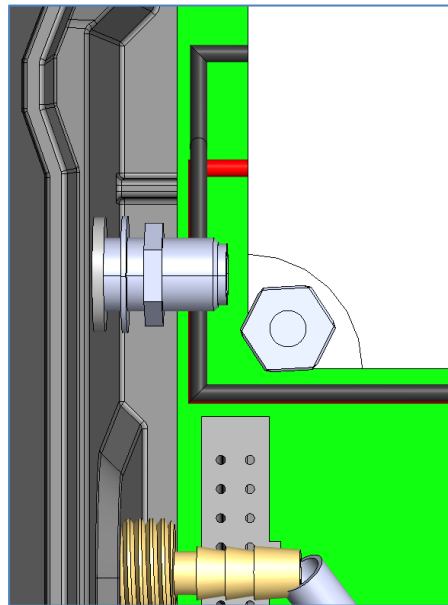
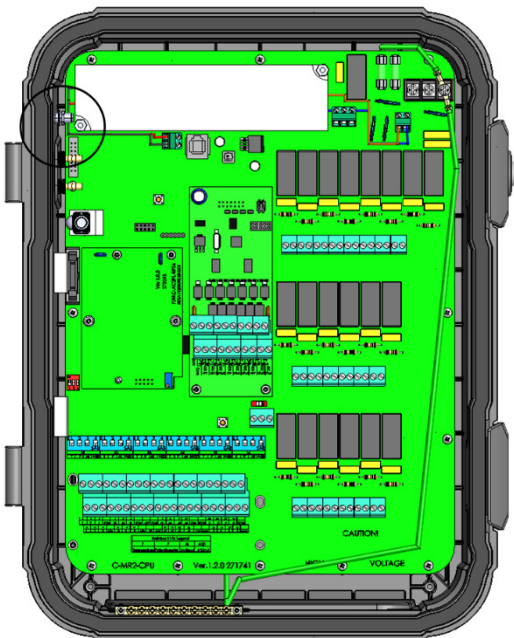

3. Thread the modem cable to the connector as shown below.

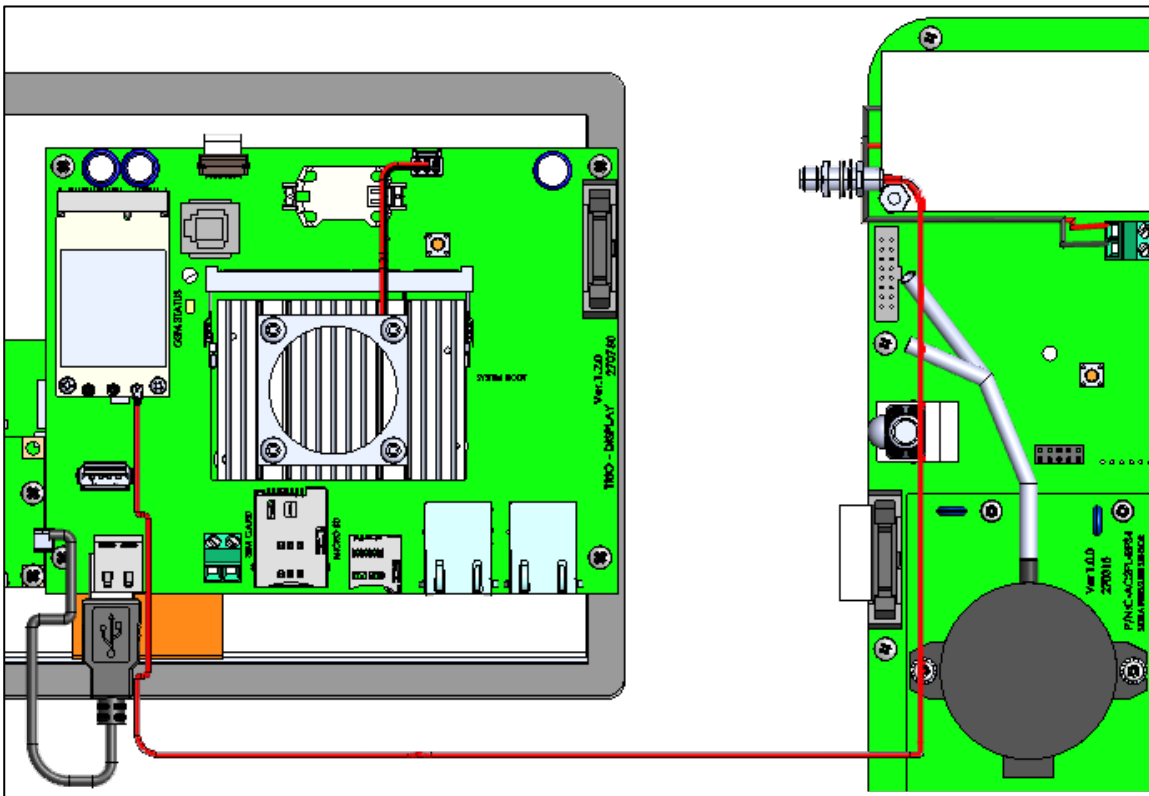
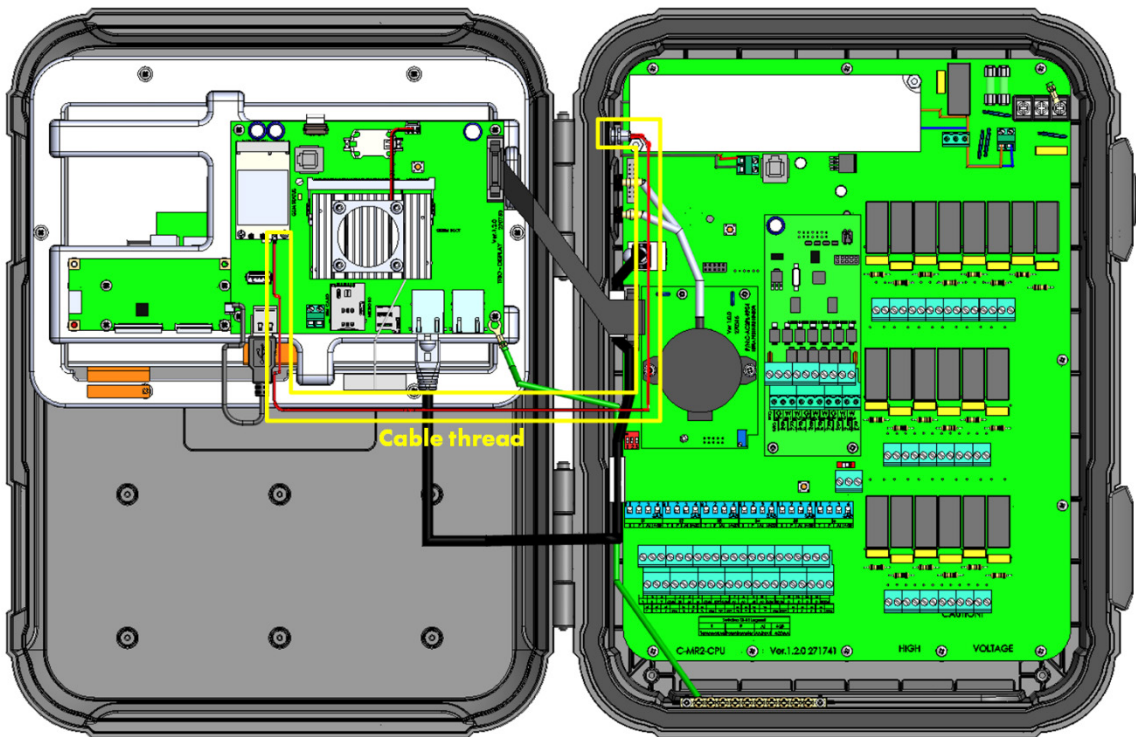

11.2.2 CONFIGURATION

NOTE The cellular Modem function appears only if a modem is installed with a working SIM card.

To configure the cell modem:

1. Go to System > General Settings > Network.

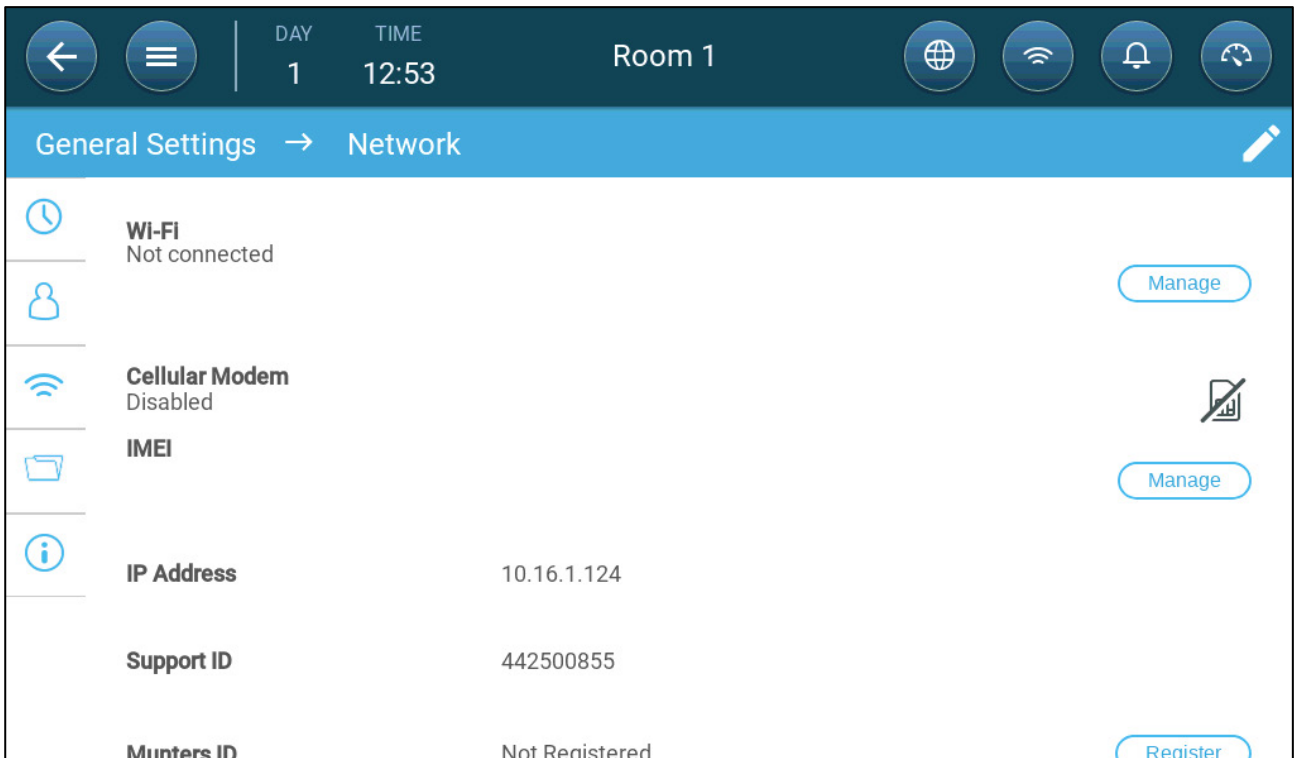

2. Under Cellular Modem, click **Manage**.

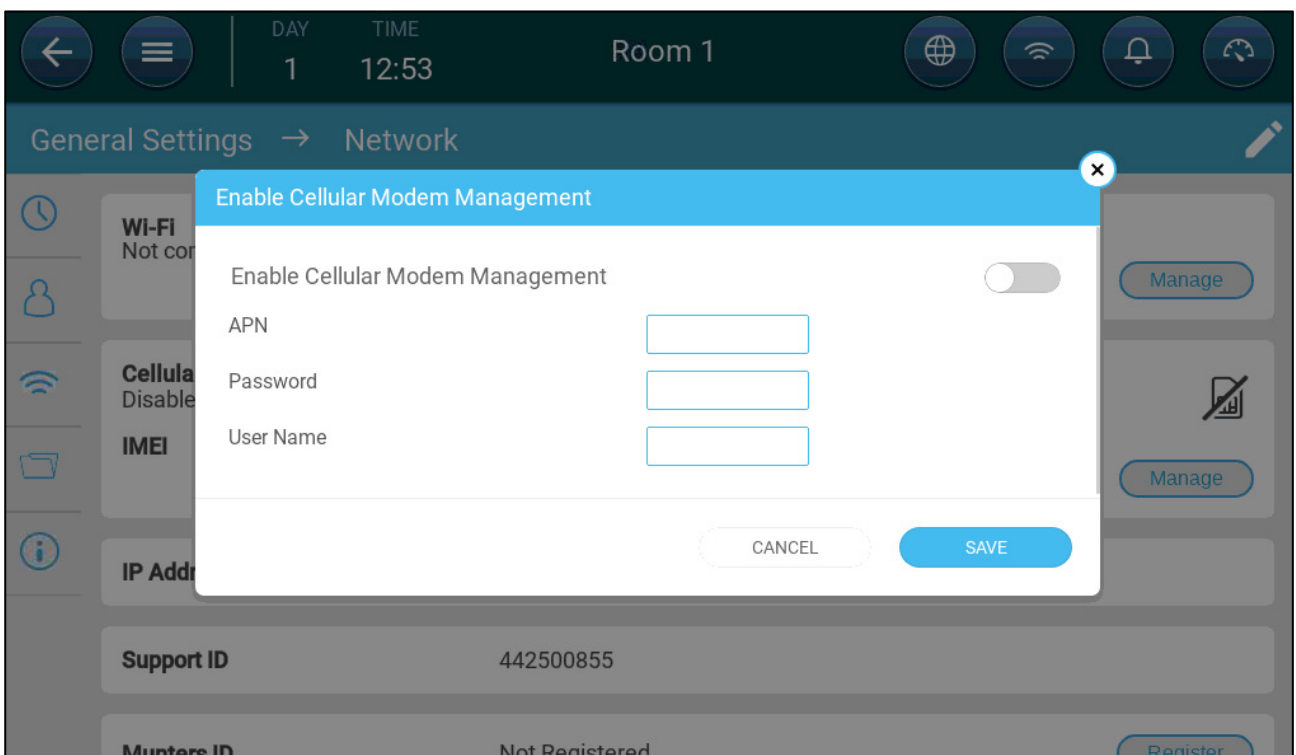

3. Under Cellular Modem, click **Manage**.

4. Final steps:

- a. Enable the modem.
- b. Using data provided by your service provider, enter the data in the fields.
- c. Click **Save**.

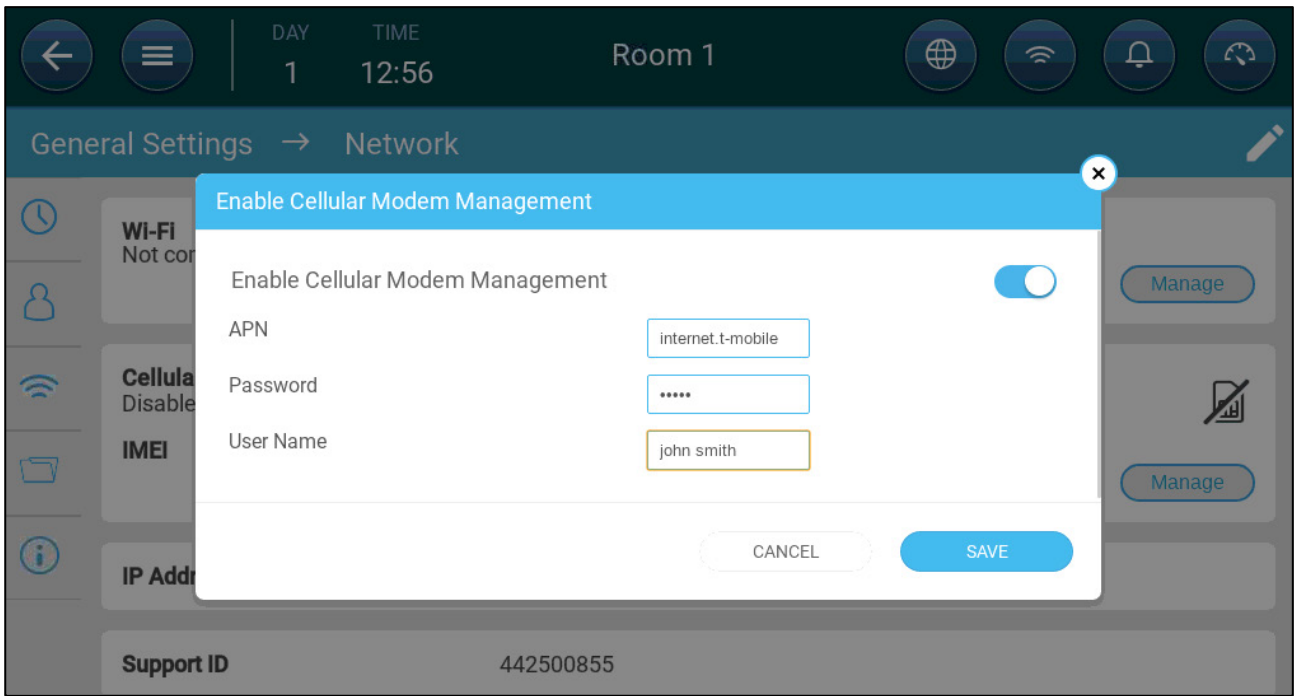

(example only!)

12 Appendix E: Panel Mount Installation

The following section details the Trio Panel Mount and Trio Expansion Panel Mount installation.

- Trio Panel Mount Installation
- Trio Expansion Panel Mount Installation

12.1 Trio Panel Mount Installation

The Trio Panel Mount consists of two elements, connected by flat ribbons and internet cable:

- Front panel (CPU panel)
- Rear panel (relay / card panel)

- Precautions
- Panels
- Panel Dimensions
- Mounting the Panels
- Panel Cables
- Powering and Alarms
- Grounding

12.1.1 PRECAUTIONS

Ensure the following:

- The setup meets electrical, mechanical and fire enclosure requirements.
- Clearance and creepage distances are maintained.
- Grounding meets industry standards.
- Ambient temperatures do not go above product requirements (50° C).
- If this unit is installed in an electrical closet, ensure that no contactors are in that closet. Placing this unit in proximity to contactors results in severe signal interference.

12.1.2 PANELS



Figure 62: Trio CPU Panel, Front View

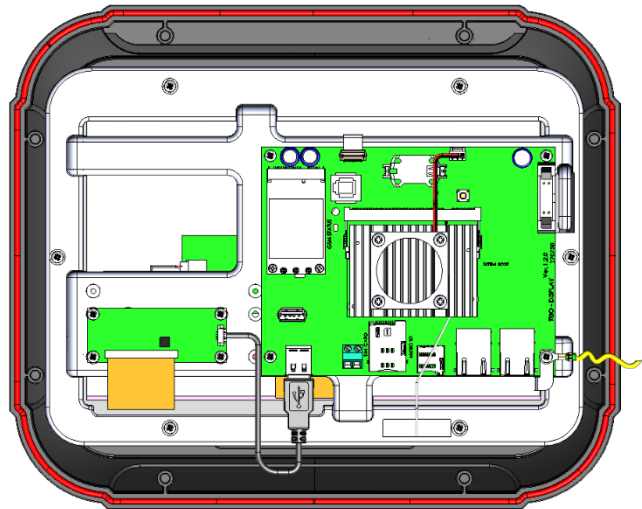

Figure 63: Trio CPU Panel, Rear View

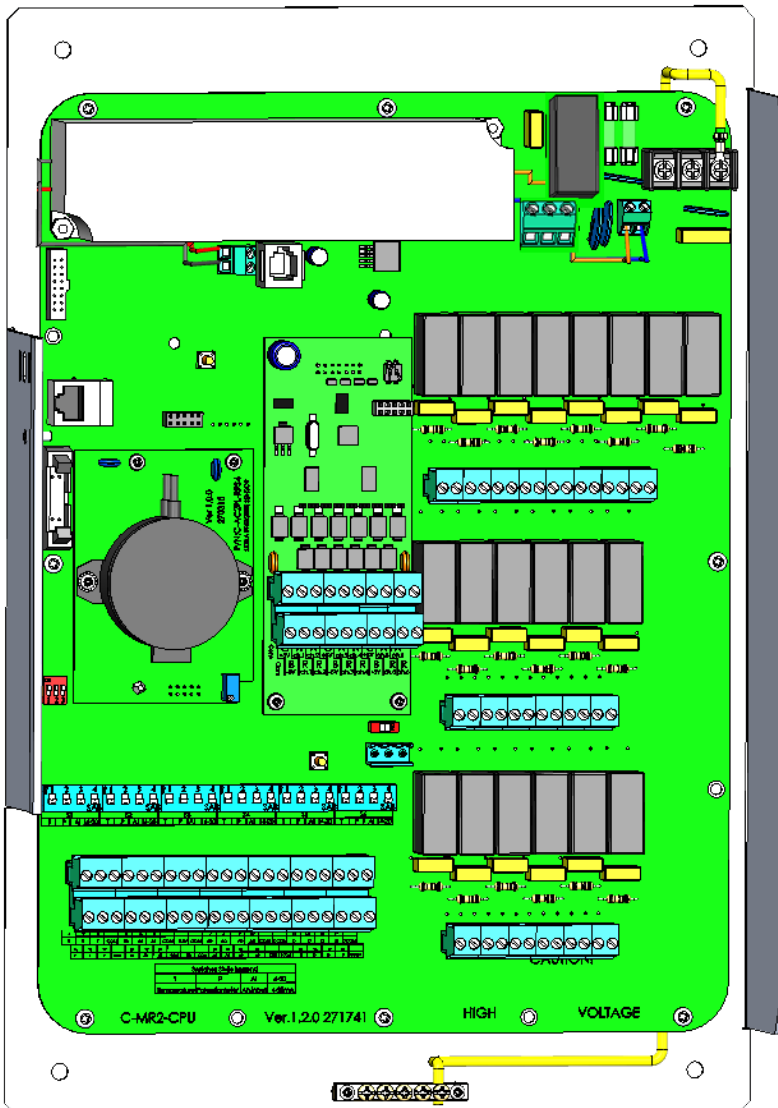

Figure 64: Trio Relay Panel, Front View

12.1.3 PANEL DIMENSIONS

Distances are in millimetres.

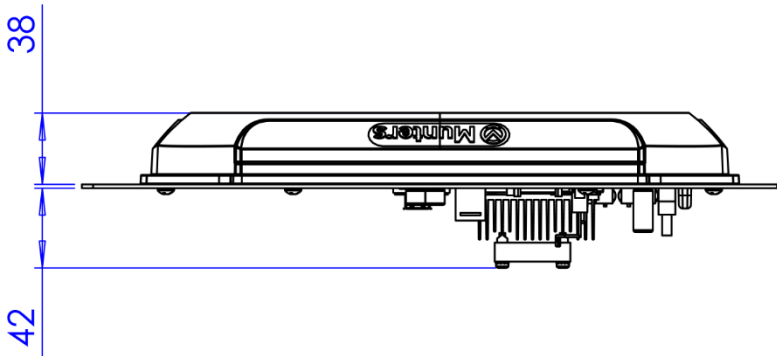

Figure 65: Front Panel Depth Dimensions

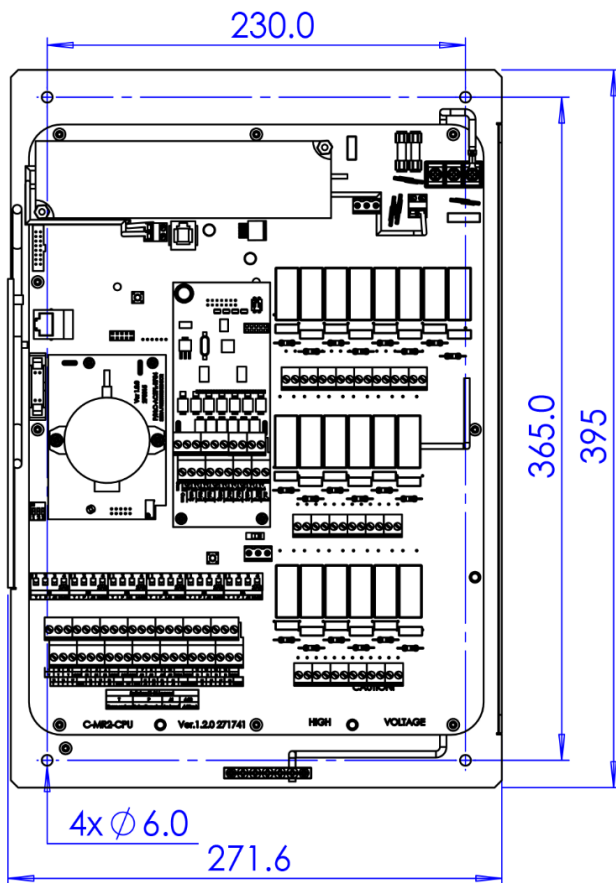

Figure 66: Rear Panel Dimensions

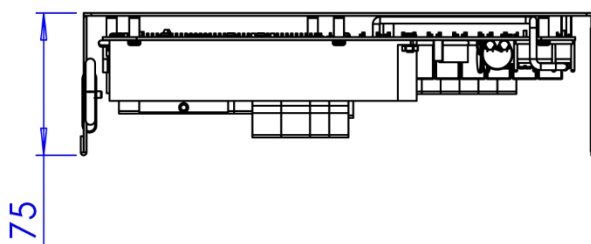

Figure 67: Rear Panel Depth Dimensions

12.1.4 MOUNTING THE PANELS

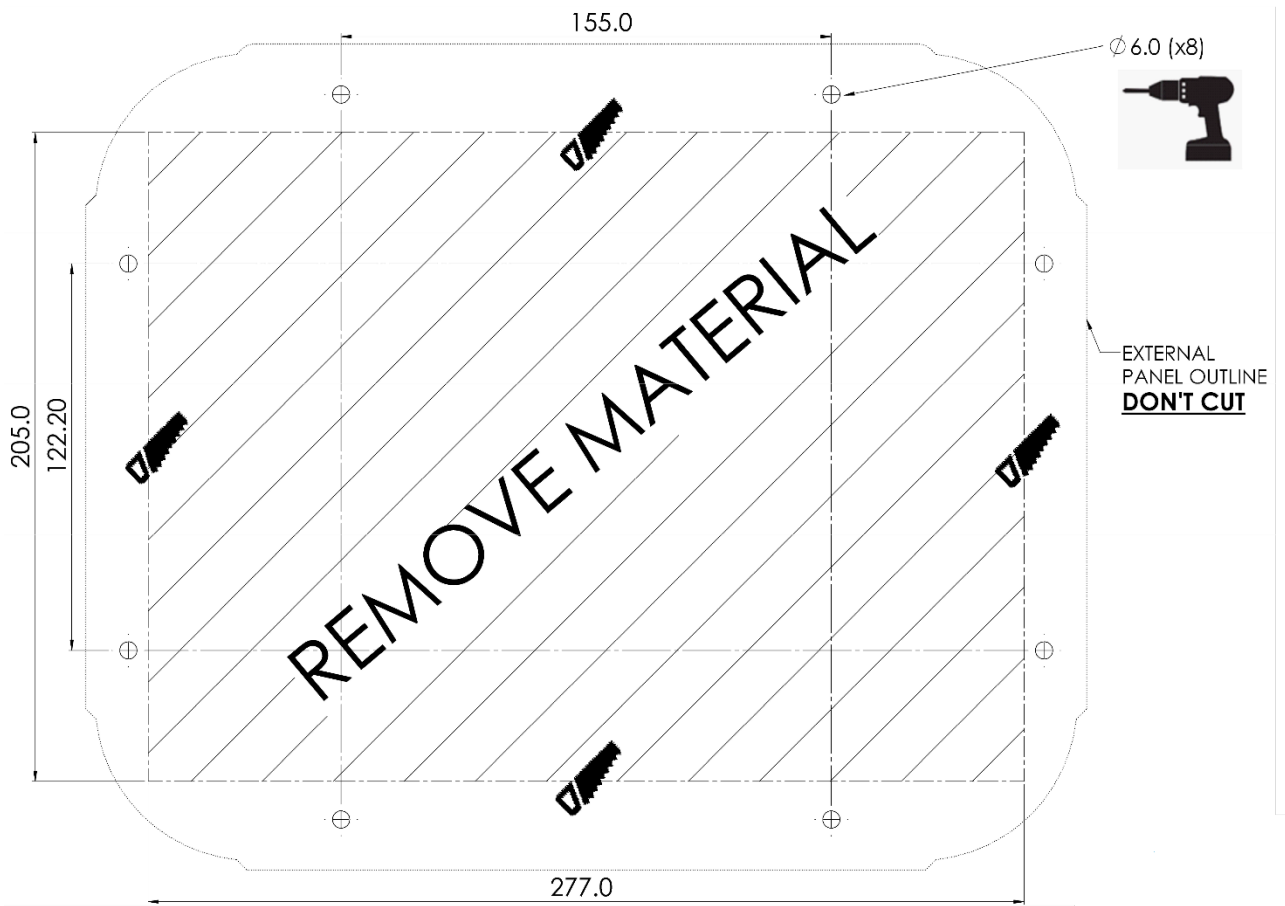

Figure 68: Panel Cutting and Drilling Dimensions (millimeters)

- Drill eight holes as indicated above.
- Using the dimensions shown, cut out a space into which the CPU Front Door is placed.

12.1.5 PANEL CABLES

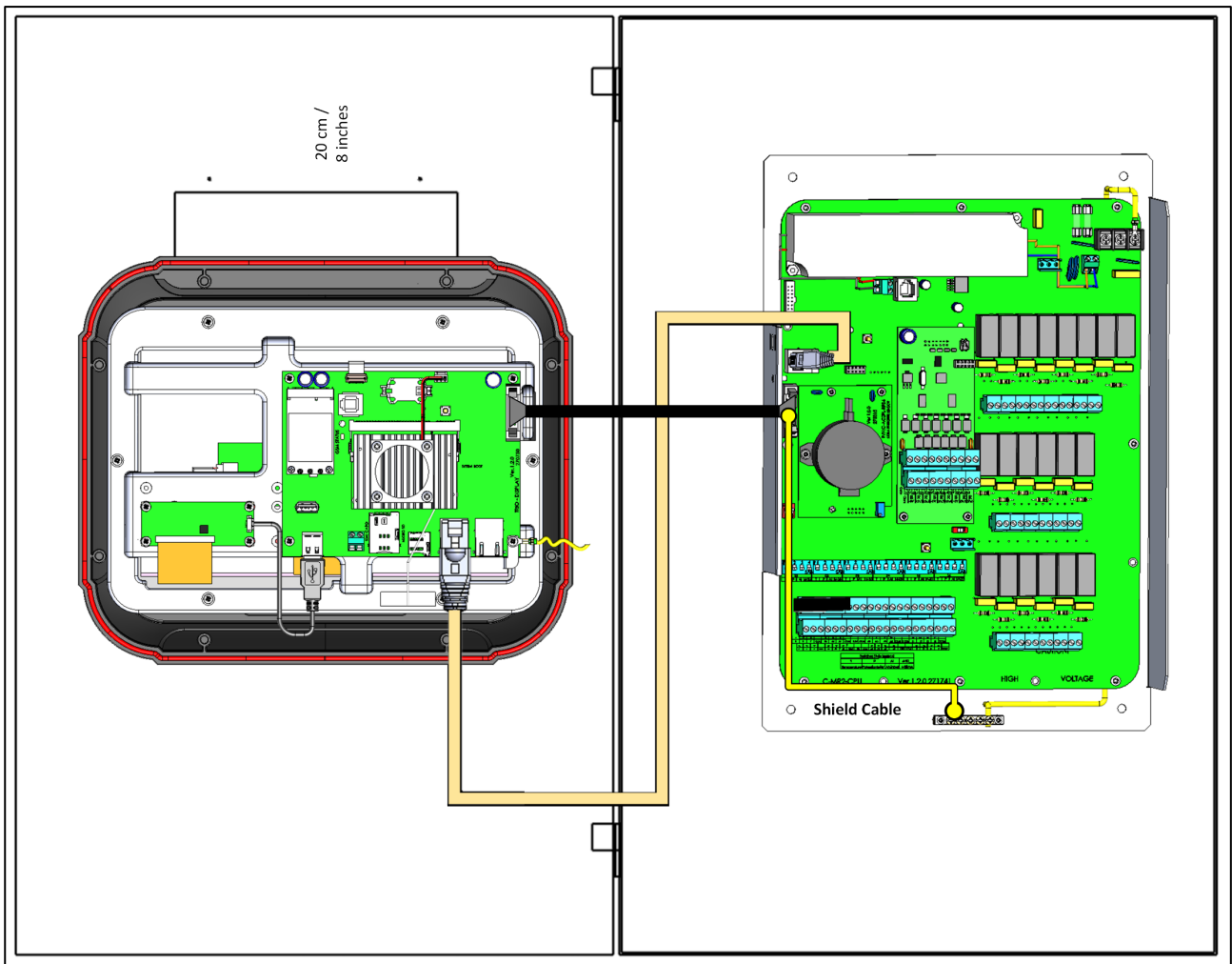

Figure 69: Panel Mount, Open Closet (sizes are not to scale)

- Connect the flat cable and internet cable as shown above.
- Mount the Trio Panel Front Door on the left door (hinge on left side).
- The distance between the Front Door and the Rear Panel must be less than one (1) meter!
- Make sure that there is at least 20 cm/8 inches between the Trio relay plate and any power contactors or other metal equipment.
- Any inverter must be at least five meters away from the controller.
- To prevent signal disruption, do not run sensor wiring via the DIN rails.
- Do not run power wires through the area of the Trio relay plate.

12.1.6 POWERING AND ALARMS

- Connect the light or siren device to the alarm relay.

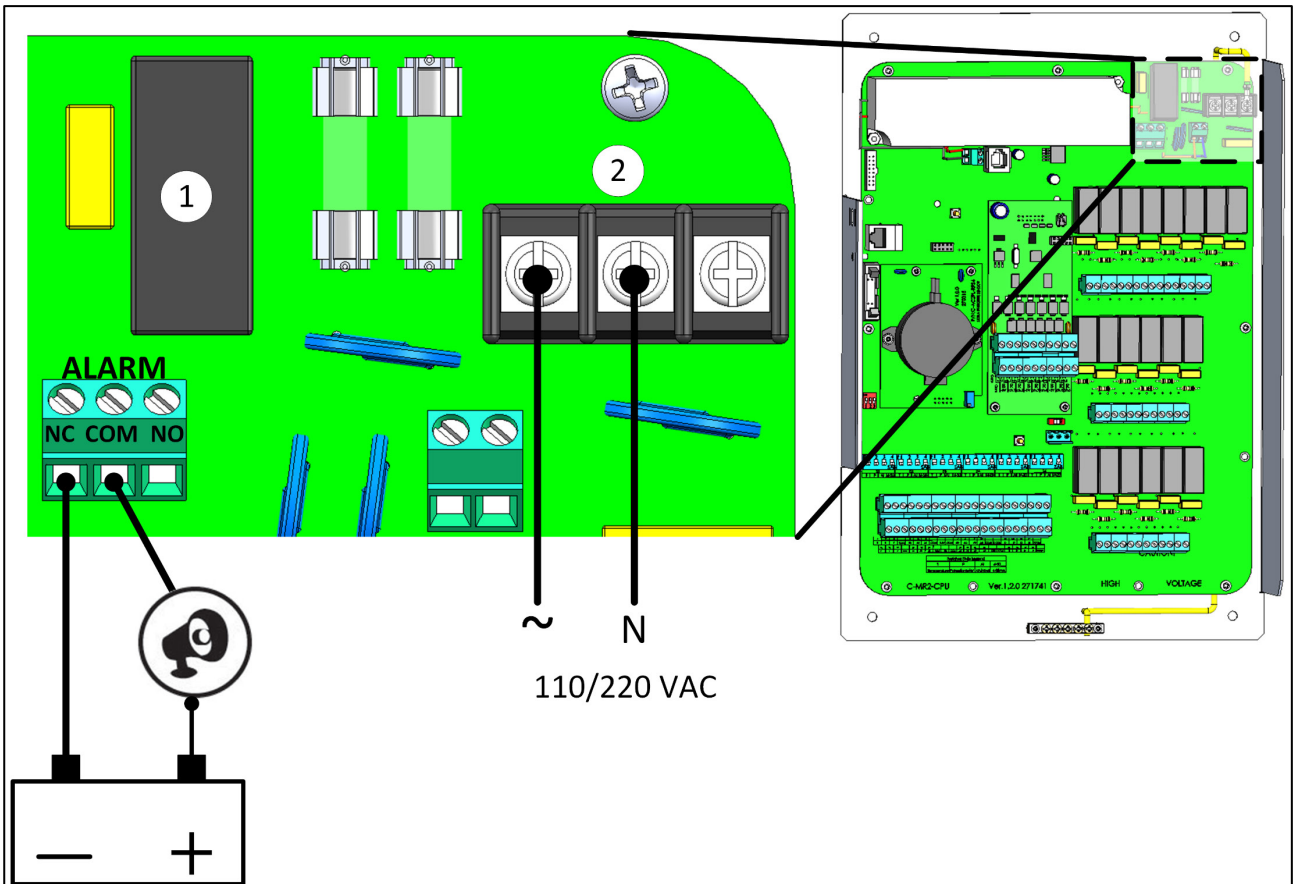

Figure 70: Alarm relay and power ports

1	Alarm relay
2	Power ports

12.1.7 GROUNDING

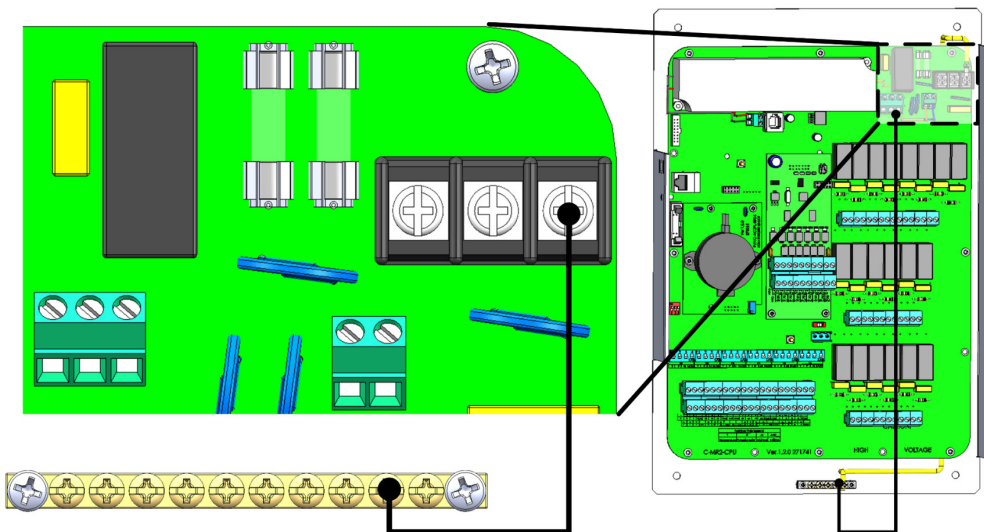

Figure 71: Grounding

CAUTION The unit must be grounded at all times!

12.2 Trio Expansion Panel Mount Installation

The Trio Expansion Panel Mount) consists of two elements, connected by flat ribbons and internet cable:

Trio Expansion Panel supports 10 or 20 relays.

- 10 relays: P/N 940-10-10001
- 20 relays: P/N 940-10-10002

- Precautions
- Panels
- Panel Dimensions
- Panel Expansion Wiring

12.2.1 PRECAUTIONS

Ensure the following:

- The setup meets electrical, mechanical and fire enclosure requirements.
- Clearance and creepage distances are maintained.
- Grounding meets industry standards.
- Ambient temperatures do not go above product requirements (50° C).
- Ensure that no contactors are in that closet. Placing this unit in proximity to contactors results in severe signal interference.

12.2.2 PANELS

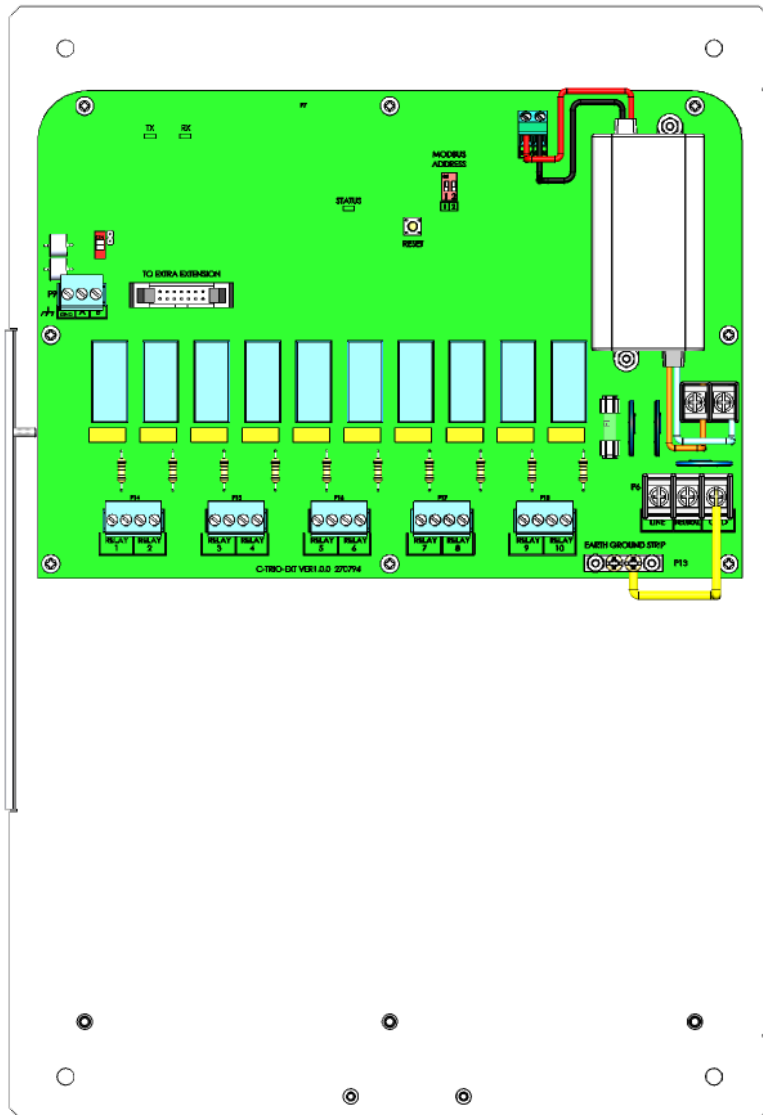

Figure 72: Trio Expansion 10 Relay Panel, Front View

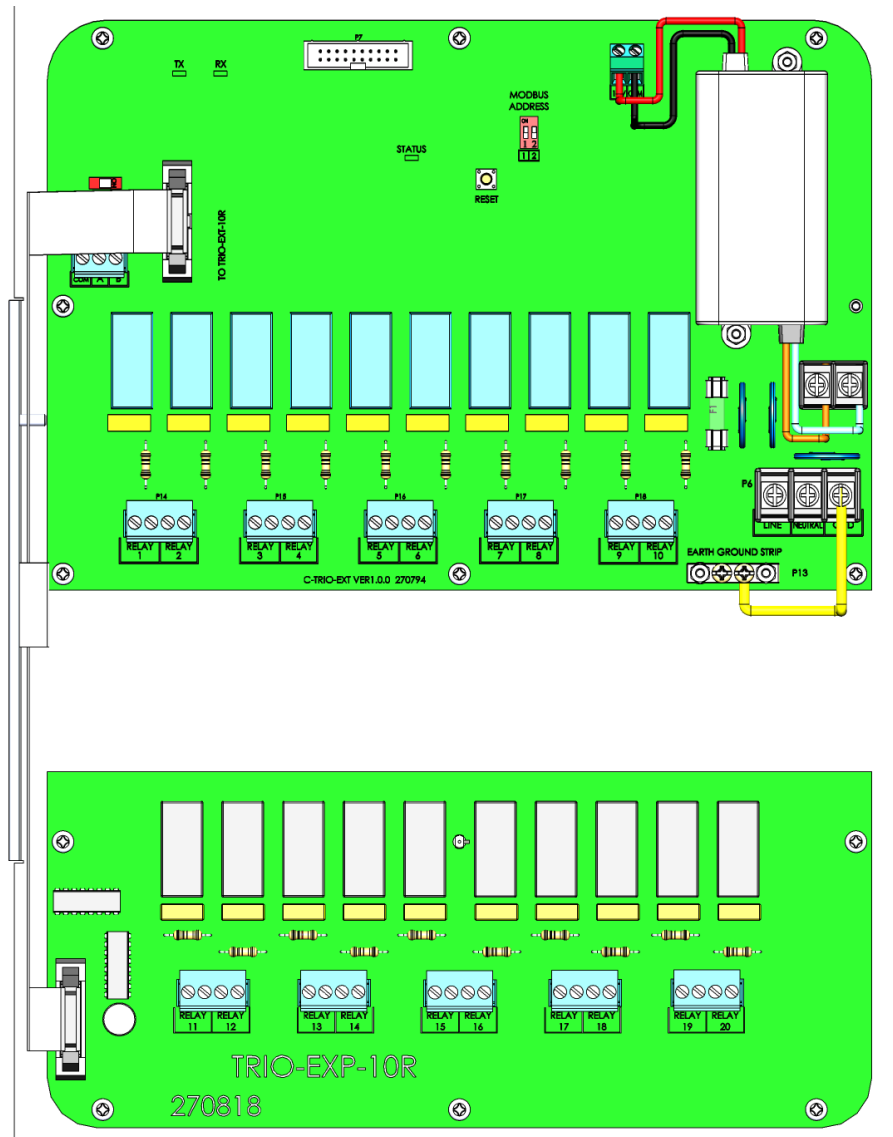

Figure 73: Trio Expansion 20 Relay Panel, Front View

12.2.3 PANEL DIMENSIONS

Distances are in millimetres.

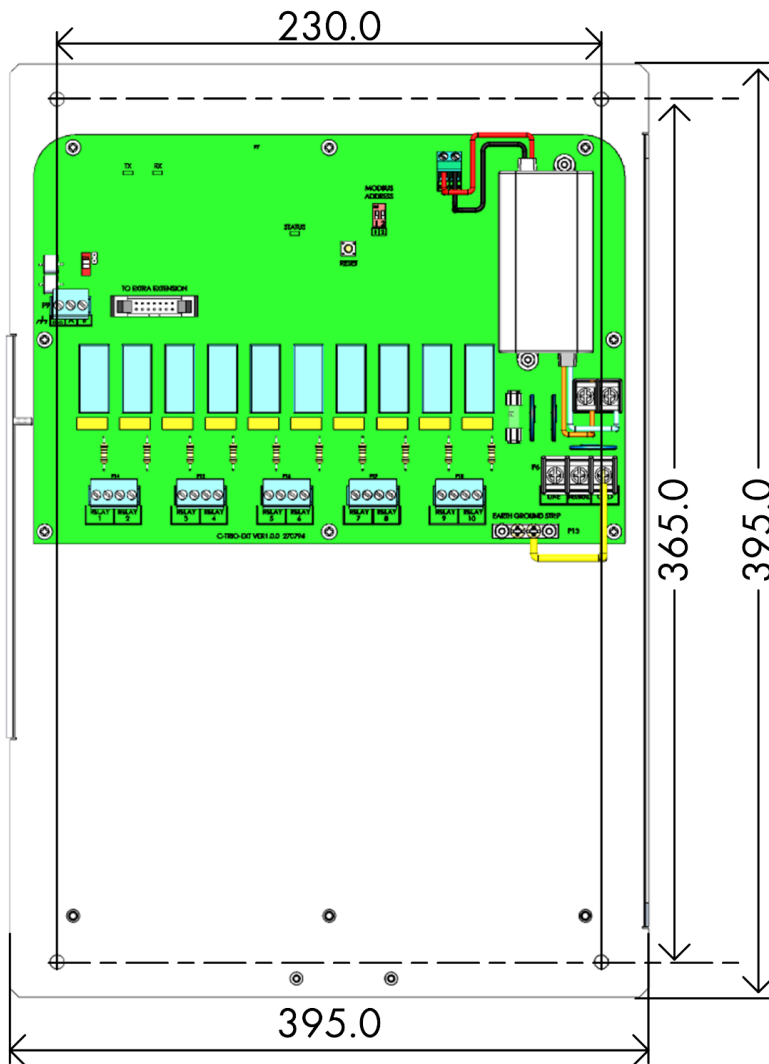

Figure 74: Expansion Rear Panel Dimensions

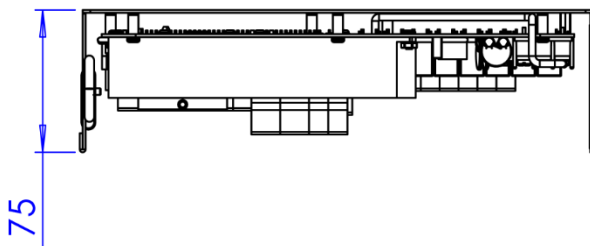

Figure 75: Rear Panel Depth Dimensions

12.2.4 PANEL EXPANSION WIRING

Connecting the Trio to its Expansion Unit consists of three steps:

- Wiring
- Address
- Restart

12.2.4.1 Wiring

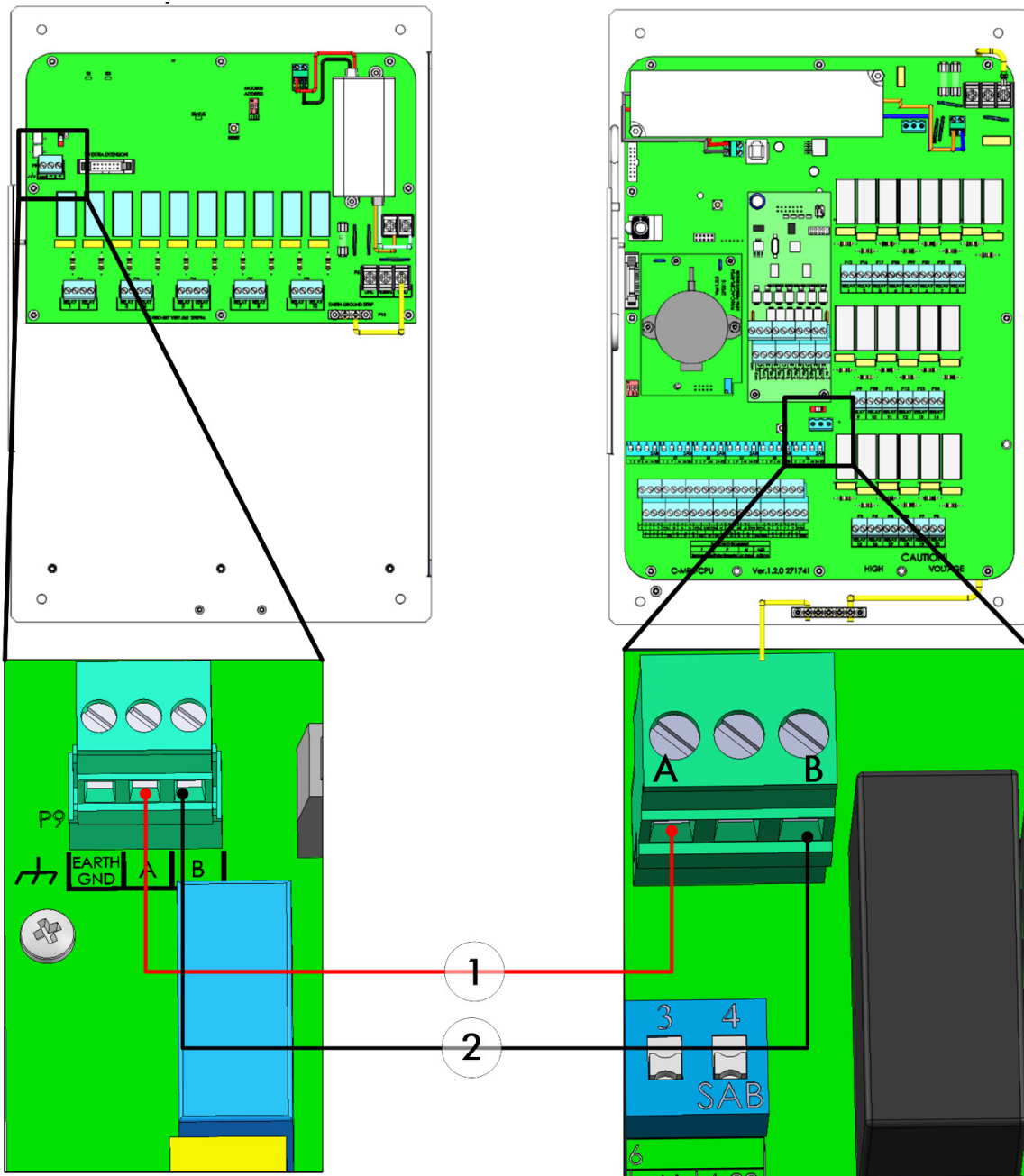

Figure 76: Panel Mount/Expansion Panel Mount Wiring

- The cable between the controller and the expansion unit should be a 4-wire twisted shielded cable (22 or 24 AWG).
- 1 – red wire
- 2 – black wire

12.2.4.2 Address

The Trio Panel can support one expansion unit. Verify that both dipswitches in the Modbus Address are set to ON.

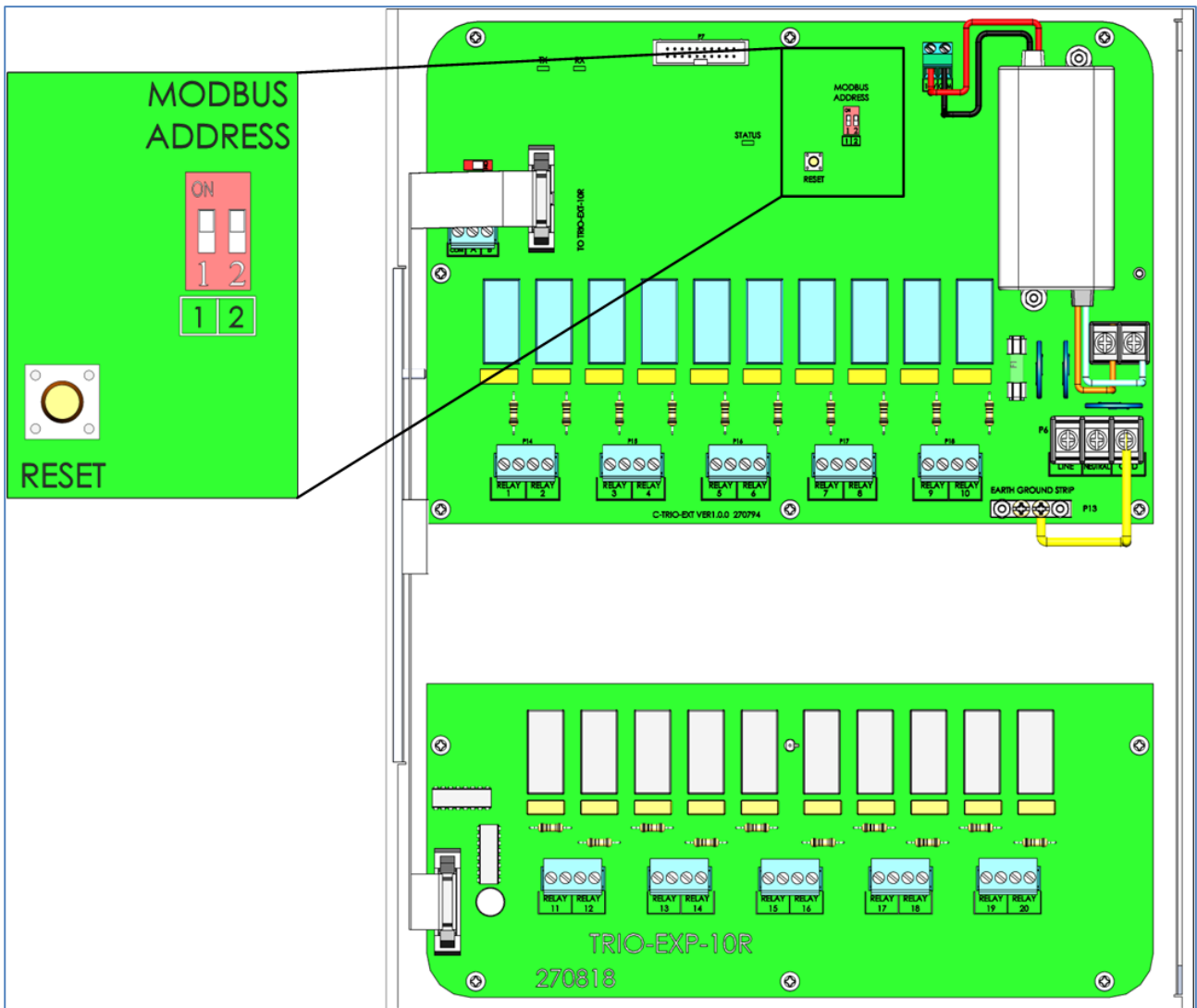
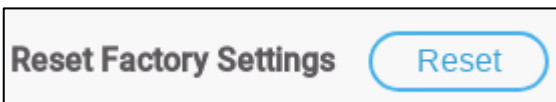

Figure 77: Panel Expansion Address

12.2.4.3 Restart

After connecting the units and verifying the Modbus address, reset the factory settings.

1. Go to System > General Settings > .



2. Click
3. Follow the on-line instructions. You have the option of backing up the settings. Refer to the User Manual for more information.

12.2.5 POWER

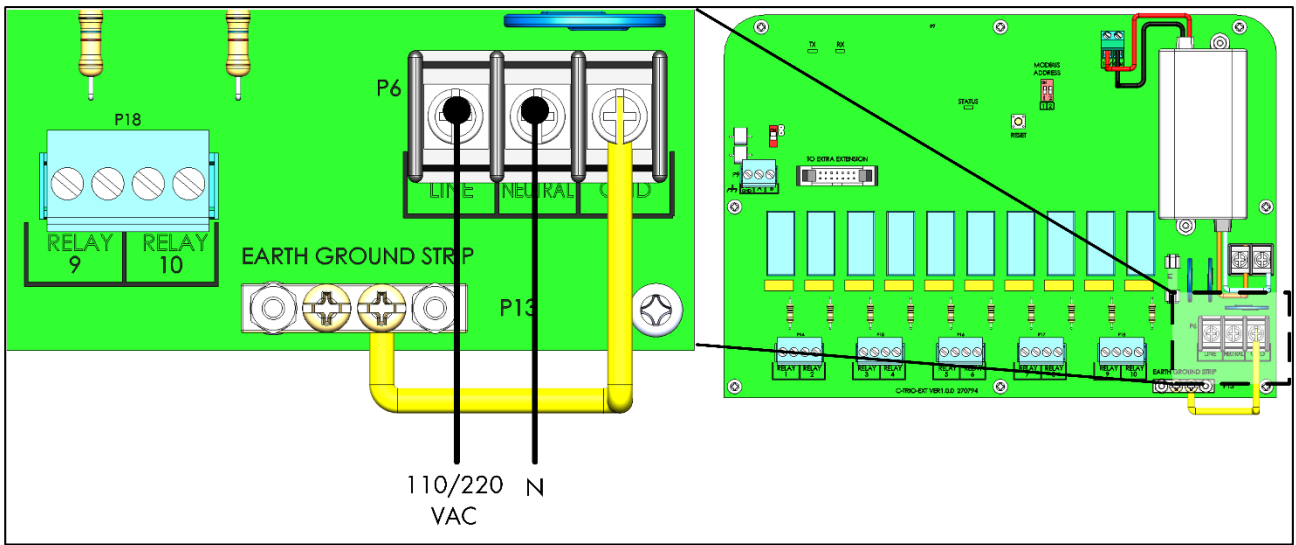

Figure 78: Power ports

13 Appendix F: Ethernet Requirements

13.1 Wire/Optical Ethernet Infrastructure Basics

- Wire Ethernet 1100/1000 BaseT Copper
 - Media – CAT5E or CAT6 Cable with maximum segment length of 100 meters
- Optical Ethernet 1000Base-X Optical
 - 1000Base-SX Media – Short Haul multi-mode optic fiber (MMF) with maximum segment length of 220 meters (62.5/125 μ m type) or 550 meters (50/125 μ m type)
 - 1000Base-LX Media – Long Haul single-mode optic fiber (SMF) with maximum segment length of 10000 meters
- Connectivity
 - Connectivity is Point-to-Point using 100/1000 Switches
 - Low latency network
- Equipment
 - Wire Switch serves for Ethernet switching over wire connectivity
 - Could be with preinstalled specific Optic Transceiver (short or long haul)
 - Could be with the SFP port, serving for pluggable SFP Optic Transceiver
 - SFP Transceiver pluggable device serving to transmit data over optic fiber
 - 1000Base-SX SFP serves for multi-mode optic fiber (MMF) of 62.5/125 μ m type or 50/125 μ m type
 - 1000Base-LX SFP serves for single-mode optic fiber (SMF)
 - Media Converters server for converting from optics to wire and vice versa. This is used for segments over 100 meters / 330 feet.

13.2 Trio Connectivity: 100/1000Gbps Ethernet Switch

- The switch is wired to the router and modem to access the Internet.
- Switches can be wired to each other by Ethernet cables, each one splitting off to other devices.
- Gigabit switches support 100 and 1,000 Mbps.

14 Warranty

Warranty and technical assistance

Munters products are designed and built to provide reliable and satisfactory performance but cannot be guaranteed free of faults; although they are reliable products they can develop unforeseeable defects and the user must take this into account and arrange adequate emergency or alarm systems if failure to operate could cause damage to the articles for which the Munters plant was required: if this is not done, the user is fully responsible for the damage which they could suffer.

Munters extends this limited warranty to the first purchaser and guarantees its products to be free from defects originating in manufacture or materials for one year from the date of delivery, provided that suitable transport, storage, installation and maintenance terms are complied with. The warranty does not apply if the products have been repaired without express authorisation from Munters, or repaired in such a way that, in Munters' judgement, their performance and reliability have been impaired, or incorrectly installed, or subjected to improper use. The user accepts total responsibility for incorrect use of the products.

The warranty on products from outside suppliers fitted to Trio, (for example antennas, power supplies, cables, etc.) is limited to the conditions stated by the supplier: all claims must be made in writing within eight days of the discovery of the defect and within 12 months of the delivery of the defective product. Munters has thirty days from the date of receipt in which to take action, and has the right to examine the product at the customer's premises or at its own plant (carriage cost to be borne by the customer).

Munters at its sole discretion has the option of replacing or repairing, free of charge, products which it considers defective, and will arrange for their despatch back to the customer carriage paid. In the case of faulty parts of small commercial value which are widely available (such as bolts, etc.) for urgent despatch, where the cost of carriage would exceed the value of the parts, Munters may authorise the customer exclusively to purchase the replacement parts locally; Munters will reimburse the value of the product at its cost price.

Munters will not be liable for costs incurred in demounting the defective part, or the time required to travel to site and the associated travel costs. No agent, employee or dealer is authorised to give any further guarantees or to accept any other liability on Munters' behalf in connection with other Munters products, except in writing with the signature of one of the Company's Managers.

WARNING: In the interests of improving the quality of its products and services, Munters reserves the right at any time and without prior notice to alter the specifications in this manual.

The liability of the manufacturer Munters ceases in the event of:

- dismantling the safety devices;
- use of unauthorised materials;
- inadequate maintenance;
- use of non-original spare parts and accessories.

Barring specific contractual terms, the following are directly at the user's expense:

- preparing installation sites;
- providing an electricity supply (including the protective equipotential bonding (PE) conductor, in accordance with CEI EN 60204-1, paragraph 8.2), for correctly connecting the equipment to the mains electricity supply;
- providing ancillary services appropriate to the requirements of the plant on the basis of the information supplied with regard to installation;
- tools and consumables required for fitting and installation;
- lubricants necessary for commissioning and maintenance.

It is mandatory to purchase and use only original spare parts or those recommended by the manufacturer.

Dismantling and assembly must be performed by qualified technicians and according to the manufacturer's instructions.

The use of non-original spare parts or incorrect assembly exonerates the manufacturer from all liability.

Requests for technical assistance and spare parts can be made directly to the nearest [Munters office](#).

