

EM50

Assembly manual



Spare part list + Assembling guideline

EM50

Air extraction fan



EM50

Assembly manual

Original instructions
Revision 1.7

This document is destined for the user of the apparatus: it may not be reproduced in whole or in part, committed to computer memory as a file or delivered to third parties without the prior authorisation of the assembler of the system.

Munters Italy S.p.A. reserves the right to effect modifications to the apparatus in accordance with technical and legal developments and to make alterations to specifications, quantities, etc., for production or other reasons, subsequent to publication.

Index

<i>chapter</i>		<i>page</i>
1.	SPARE PART LIST	4
	EM50 exploded view	4
	Motor exploded view	11
2.	ASSEMBLING TOOLS	13
3.	ASSEMBLING GUIDELINE	15
	Housing assembling	15
	Centrifugal system and pulley to propeller assembling	17
	Shutter blades assembling	19
	Safety meshes assembling	21
	CE kit assembling	22
	Pyramidal shape mesh assembling	23



WARNING

All the components and spare parts MUST be stored in dry and clean environment.





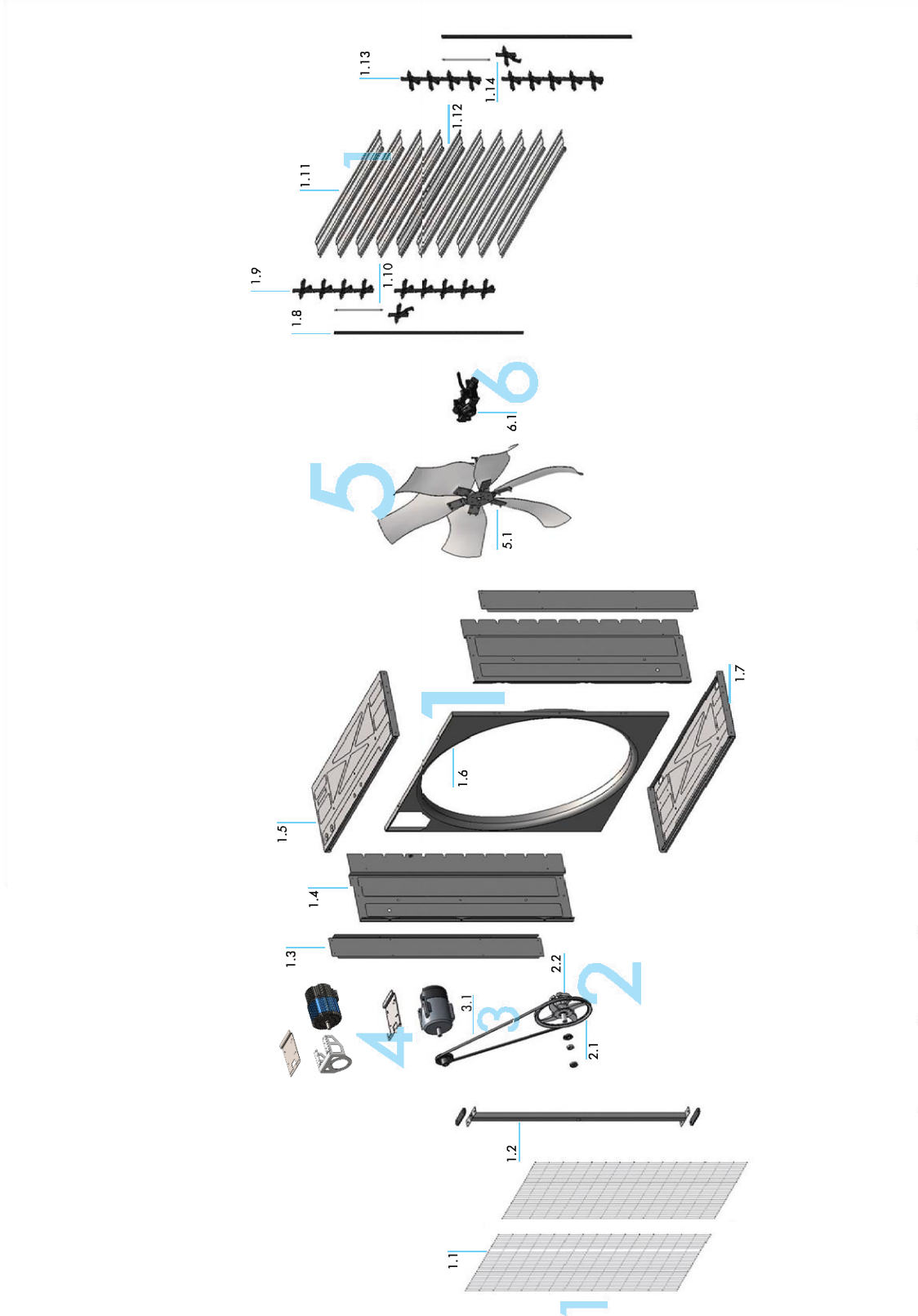



Spare part list

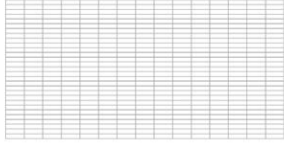







1.















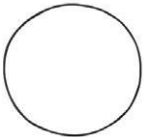

Groups 1: Body 2: Pulley 3: V-belt 4: Motor 5: Propeller 6: Centrifugal system 7: Bolts&nuts* 8: Optional kits*









* Not shown in the exploded view







Ref.	Picture	Description	Q. ty
GROUP1: BODY			
1.1		SAFETY MESHES 670X1,338 23X89 GALV.	2
1.2		CENTRAL SUPPORT GALV.	1
1.3		COVER PLATE GALV.	2
1.4		SIDE PANEL 515X1,367X0.8 GALV	2
1.5		TOP PANEL 549X1,457X1 GALV.	1
1.6		VENTURI 1,425X1,425 GALV.	1
1.7		BOTTOM PANEL 549X1,457X1 GALV.	1
1.8		PVC TIE-ROD	2

1.9		RIGHT SIDE SHUTTER BEARING ASSEMBLY	9
1.10		RIGHT SIDE SHUTTER BEARING ASSEMBLY WITH SPRING	1
1.11		SHUTTER BLADE GALV.	9
1.12		CENTRAL SHUTTER BLADE GALV.	1
1.13		LEFT SIDE SHUTTER BEARING ASSEMBLY	9
1.14		LEFT SIDE SHUTTER BEARING ASSEMBLY WITH SPRING	1
1.15		MUNTERS STICKER 17.5X80	2
1.16		WARNING STICKER A-1997 35X210	1
1.17		WARNING STICKER B-1997 70X105	1

1.18		PRODUCT LABEL G-1998 95X115	1
1.19		NO HIGH PRESSURE STICKER 42X118	2
GROUP2: PULLEY			
2.1		CENTRAL PULLEY	1
2.2		HUB	1
GROUP3: BELT			
3.1		V-BELT	1
GROUP4: MOTOR			
SEE MOTOR TABLE (p.10)			
GROUP5: PROPELLER			
5.1		PROPELLER STAINLESS STEEL/PRECOATED/GALV.	1

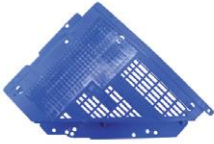
GROUP6: CENTRIFUGAL SYSTEM			
6.1		COMPLETE CENTRIFUGAL SYSTEM SINGLE/MULTI SPEED	1
GROUP7: BOLTS&NUTS			
7.1		POP RIVET D6.4X8 <i>Purpose: for housing and Venturi assembling</i>	20
7.2		THREADED BUSH D8X17.5 M8 LONG <i>Purpose: to insert on the housing</i>	8
		THREADED BUSH D8X12.5 M8 SHORT <i>Purpose: to insert on the top panel</i>	2
7.3		HEXAGON SCREW M8X16 UNI 5739	2
		PLAIN WASHER D8X32 DIN 126 <i>Purpose: to fix motor to the top panel</i>	2
7.4		HEXAGON SOCKET SCREW M10X30 UNI 5923	4
		OVAL PLATE 170X40X8	2
		TOOTHED WASHER D10.5X18 UNI 5589	4
		TICK HEXAGON NUT M10X10 UNI 5587	4
		<i>Purpose: to fix the propeller central support to the housing</i>	
7.5		HEXAGON SCREW M6X30 UNI 5739	4
		'-' / (&%)&9 / 65 .6 %* / 6923 <i>Purpose: to fix the central pulley to the hub</i>	4
7.6		HEXAGON SCREW M8X25 UNI 5739	4
		TOOTHED WASHER D8.4X15 UNI 6798	4
		TICK HEXAGON NUT M8X8 UNI 5587	4
		<i>Purpose: to fix the propeller to the hub</i>	
7.7		HEXAGON SOCKET HEAD CAP SCREW M8X55 UNI 5931	2
		TOOTHED WASHER D8.4X15 UNI 6798	2
		PLAIN WASHER D8.4X17 UNI 659	2
		TICK HEXAGON NUT M8X8 UNI 5587	2
		<i>Purpose: to fix the centrifugal system to the propeller</i>	

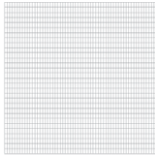
7.8		<p>WATERPROOF DISTANCE PIECE <i>Purpose: to distance the hub from the propeller central support.</i></p>	1
7.9		<p>HEXAGON SCREW M6X16 UNI 5739 CENTRAL SHUTTER BLADE FORK HEXAGON NUT M6X5 UNI 5588 <i>Purpose: to fix the central shutter blade fork to the central shutter blade.</i></p>	2 1 2
7.10		<p>THIN HEXAGON NUT M25X10 UNI 5589 CUP COVER NUT <i>Purpose: to fix the hub to the propeller central support.</i></p>	1 1
7.11		<p>SPRING HOOK <i>Purpose: to fix the two springs of central shutter blade to the side panel.</i></p>	2
7.12		<p>KNURLED AXLE D6X33 <i>Purpose: to fix the tie-rod to the central shutter blade fork.</i></p>	1
7.13		<p>SELF TAPPING SCREW 6.3X19 PLAIN WASHER D6.7X24 UNI 659 <i>Purpose: for cover plate and wire meshes assembling.</i></p>	15 1
7.14		<p>BLUE 1-45\$ CLIP MESHES <i>Purpose: to fix the safety meshes to the housing.</i></p>	4
7.15		<p>RUBBER GROMMET <i>Purpose: to protect the electric cable on the side panel in correspondence with the motor slot.</i></p>	1

GROUP8: OPTIONAL KITS			
PLASTIC CE PROTECTION KIT			
8.1		PLASTIC SAFETY PROTECTION FOR CENTRAL PULLEY	1
8.2		PLASTIC SAFETY PROTECTION FOR BELT	2
8.3		PLASTIC SAFETY PROTECTION FOR MOTOR PULLEY AND FIXING CLIP	1
8.4		SELF TAPPING HEX SCREW D6.3X19	1
PYRAMIDAL SAFETY MESH KIT			
8.5		PYRAMIDAL SAFETY MESH	1
8.6		SELF TAPPING HEX SCREW D6.3X19 GREY PLASTIC CLIPS <i>Purpose: to fix the pyramidal safety mesh to the housing.</i>	6 6

GROUP4: MOTOR - standard equipment

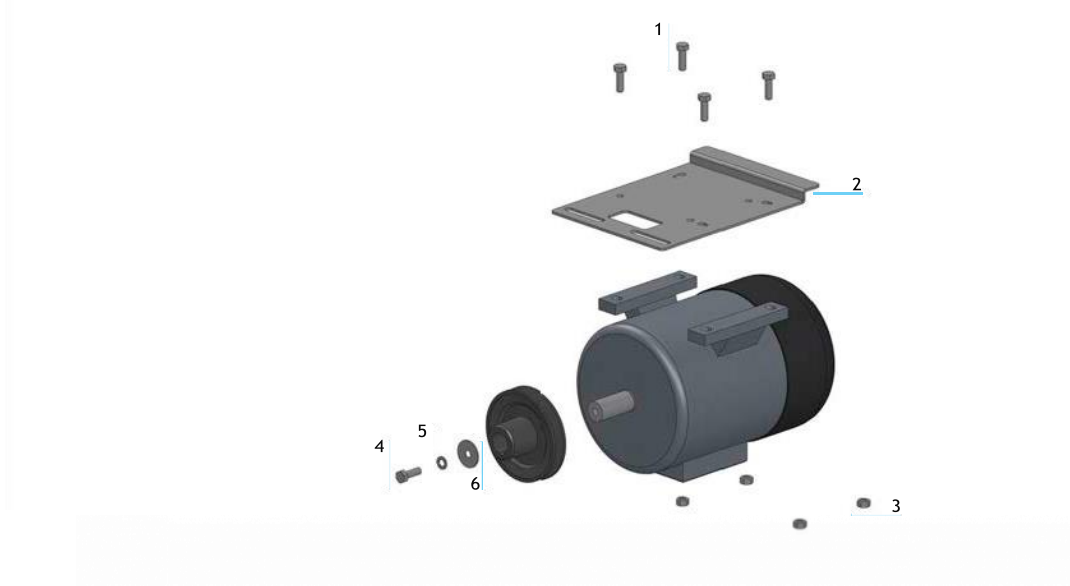

MOTOR PULLEY PITCH DIAMETER AND HOLE						
	3-PHASE - ONE SPEED		3-PHASE - MULTISPEED		SINGLE PHASE	
	50 HZ	60 HZ	50 HZ	60 HZ	50 HZ	60 HZ
HP 1.5	100/24	80/24	95/24	80/24	95/24	80/24
HP 1.0	85/19	70/19	80/19	65/19	80/19	65/19

BOLTS&SCREWS

Ref.	Description	Q.ty
Models: 1.0Hp - 50/60Hz		
1	HEXAGON SCREW M8X20 UNI 5739	4
2	MOTOR PLATE 180X250X3 MUNTERS PROTECT	4
3	TICK HEXAGON NUT M8X8 UNI 5587	4
4	DIN 126 HEX SCREW SELF-LOCKING M8×20 UNI 5739 AC	1
5	SPRING WASHER D8,4X14,4 UNI1751	1
6	PLAIN WASHER D8X32	1
Models: 1.5Hp - 50/60Hz		
1	HEXAGON SCREW M8X20 UNI 5739	4
2	MOTOR PLATE 180X250X3 GALV.	4
3	TICK HEXAGON NUT M8X8 UNI 5587	4
4	HEXAGON SCREW M6X16 UNI 5739	1
5	SPRING WASHER D6,4X11,4 UNI1751	1
6	PLAIN WASHER D6.7X24 UNI 659	1

GROUP4: MOTOR - E-Line equipment

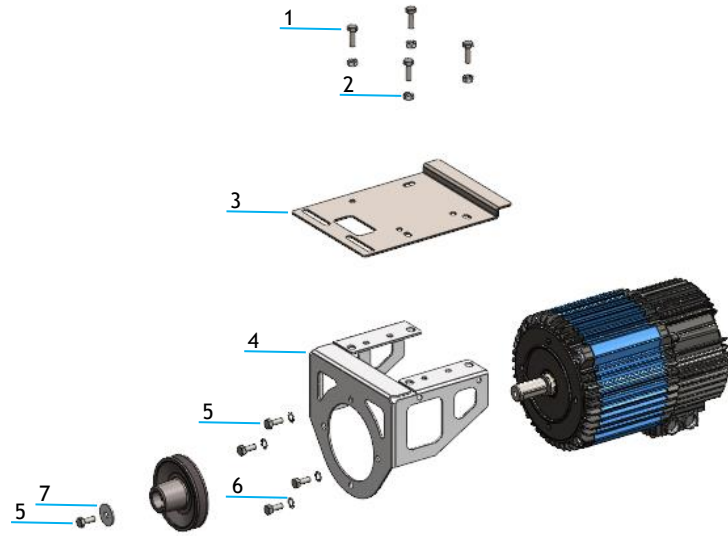

MOTOR PULLEY PITCH DIAMETER AND HOLE		
	3-PHASE - ELECTRONICALLY COMMUTATED	
	50 HZ	60 HZ
E-Line	100/24	

BOLTS&SCREWS		
Ref.	Description	Q.ty
Models: E-LINE 2.5hp 50/60Hz		
1	HEXAGON SCREW M8X25 UNI 5739	4
2	TICK HEXAGON NUT M8X8 UNI 5587	4
3	MOTOR PLATE 180X250X3 MUNTERS PROTECT	1
4	FLANGE FOR EC MOTOR	1
5	HEX SCREW SELF-LOCKING M8×20 UNI 5739 AC	5
6	Ø8.4 EXT THOOTED WASHER UNI 6798 G	4
7	Ø8X32 WASHER DIN 126	1

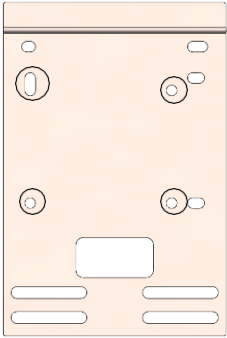
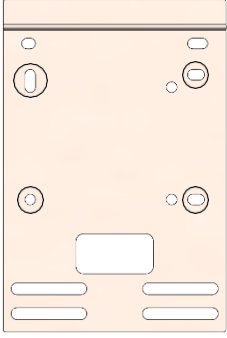
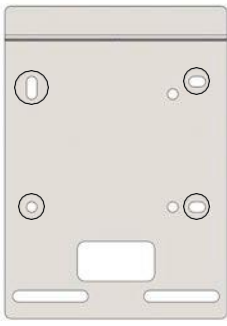
HOLES FOR MOTOR	
	○ = Holes for 1.0hp motors
	○ = Holes for 1.5hp
	○ = Holes for E-LINE 2.5hp motors

Assembling tools

2.

Ref.	Picture	Description	Q.ty
1		RIVETING MACHINE RAC171	1
2		INSERTING MACHINE KJ 45	1
3		PNEUMATIC SCREWDRIVER	1
4		17mm SPANNER	1
5		10mm LONG SPANNER	1
6		13mm LONG SPANNER	1
7		6mm LONG ALLEN SPANNER	1

8		36mm SPANNER	1
9		PHILLIPS SCREW HEAD ADAPTOR	1
10		13mm SPANNER	1
11		SMALL HAMMER	1
12		10mm SPANNER	2
13		SCREWDRIVER	1
14		RATCHET DRIVE EXTENSION	1

Assembling guidelines

3.

HOUSING ASSEMBLING



Take the bottom panel (*ref.1.7/Body*), the side panels (*ref.1.4/Body*) and place these taking care that slot for the plastic bearing is downward.



Before fixing the bottom and the side panels make sure that these pieces are in the right position as in the picture.



Join bottom panel to side panels and fix qty. 4 pop rivets (*ref.7.1/Bolts&nuts*) for each edge by using riveting machine (*ref.1/Assembling Tools*).



Insert Venturi (*ref.1.6/Body*) into the housing on the right side as in the picture.



Fix Venturi to bottom panel and then to side panels with qty.1 pop rivets for side.



Place the top panel (*ref.1.5/Body*) with motor support in correspondence with motor slot on the Venturi. Then fix it to side panels with qty. 4 pop rivets for side and to Venturi with qty.1 pop rivet.



Place the qty.2 short threaded bushes (*ref.7.2/ Bolts&nuts*) on the top panel by using inserting machine (*ref.2/Assembling Tools*).



Place long threaded bushes (*ref.7.2/Bolts&nuts*) in correspondence of proper holes around the housing. Qty. 2 long threaded bushes for each panel. Make sure that Venturi and each panel are joined by the long threaded bushes.

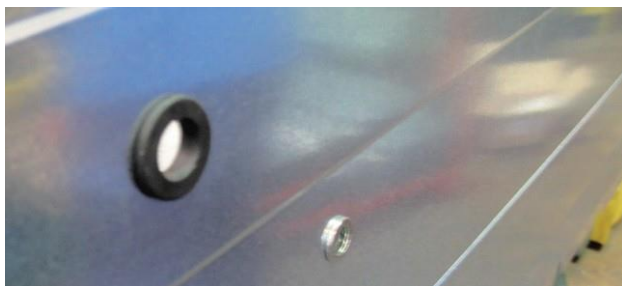

Place the rubber grommet (*ref.7.15/Bolts&nuts*) for electric cable protection on the side panel in correspondence with the motor slot.



The propeller central support (*ref.1.2/Body*) shall be fixed to housing by means of qty. 4 screws, qty. 2 oval plates, qty. 4 toothed washers and qty. 4 nuts (*ref.7.4/Bolts&nuts*).



Place the oval plates between propeller central support and panels.



Place the oval plate over support frame and then start to screw the nuts.



Tighten the nuts with pneumatic screwdriver (*ref.3/Assembling tools*) in order to fix the propeller central support to the top and bottom panels.



Insert the electric motor (*ref.4/Motor*) into its slot taking care to fix it over proper track on the top side.



Fix motor slide to top panel by means qty. 2 screws and qty. 2 washers (*ref.7.3/Bolts&nuts*). Tighten screws by using 13mm spanner (*ref.10/Assembling tools*).

CENTRIFUGAL SYSTEM AND PULLEY TO PROPELLER ASSEMBLING



Place the pulley on the hub and insert the screws (*ref.7.5/Bolts&nuts*).



Turn the pulley plus the hub upside down, insert and fix the flanged nuts (*ref.7.5/Bolts&nuts*) over the screws.



Tighten the nuts by using pneumatic screwdriver (*ref.3/Assembling tools*).



Place the waterproof distance piece (*ref.7.8/Bolts&nuts*) on the axle and then place the axle on a support. Place the V-belt (*ref.3.1/Belts*) on the central pulley.



Place the propeller (*ref.5.1/Propeller*) on the central pulley assembly.



Fix the screws, washers and nuts (*ref.7.6/Bolts&nuts*) in order to fix the propeller.



Tighten the nuts by using pneumatic screwdriver (*ref.3/Assembling tools*).



Place bolts (*ref.7.7/Bolts&nuts*) on the centrifugal system (*ref.6.1/Centrifugal system*) and then place it on the propeller.



Tighten screws, washers and nuts (*ref.7.7/Bolts&nuts*) in order to fix the centrifugal system to the propeller by using pneumatic screwdriver (*ref.3/Assembling tools*).



Place the complete assembly you have obtained on the fan, inserting the axle through the central support hole.



Place the nut (*ref.7.10/Bolts&nuts*) on the axle and then tighten it by means of pneumatic screwdriver (*ref.3/Assembling tools*).



Put cap cover nut (*ref.7.10/Bolts&nuts*) over the nut (only for fan without CE kit).



Place V-belt on the pulley and then rotate the propeller clock-wise in order to tighten the V-belt on the pulley. *Check tensioning: right tensioning is obtained when maximum deflexion on one side only (half-way from motor and central pulley) is about 15 mm.*

SHUTTER BLADES ASSEMBLING



Insert plastic bearings (*ref.1.9-1.13/Body*) on shutter blades (*ref.1.11/Body*) and plastic bearings with spring (*ref.1.10-1.14/Body*) on central shutter blade (*ref.1.12/Body*). Both plastic bearings are marked with SX for left side and with DX for right side.



Fix the plastic fork with qty. 2 screws and qty. 2 nuts (*ref.7.9/Bolts&nuts*) on the central shutter blade. Fit central shutter blade on the central slot on the housing.



Insert knurled axle (*ref.7.12/Bolts&nuts*) by the smooth side on the plastic fork, then take plastic shutter rod on the centrifugal system and fix them together by using a small hammer (*ref.11/Assembling tools*).



Insert the spring hooks (*ref.7.11/Bolts&nuts*) in the holes of the side panels (*ref.1.4/Body*).



Insert the free terminal of the spring on the hook. Repeat this operation for the other side.



Insert all the shutter blades on the fan housing and then place the fan horizontally.



Place the pvc tie-rod (*ref.1.8/Body*) on plastic bearing pivots.

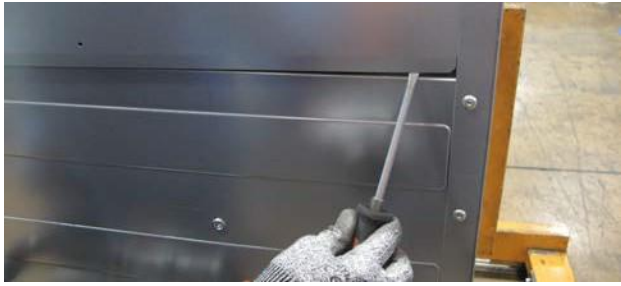

#Z Neans Pf a sDSeXdSiWeS (Sef.13/"sseNCling tPPLs) inseSt DPWeS Qlate (Sef.1.3/#PdZ) PWeS tle fan IPusing.

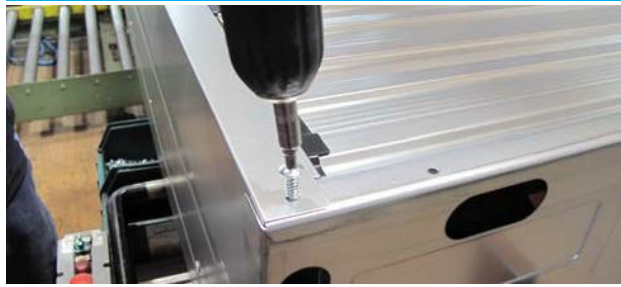

'ix tle DPWeS Qlate Pn eaDI side CZ using R.tZ 2 ρ6,3"19 sDSeXs (Sef.7.13/#Plts&nuts) Xitl tle QneuNatiD sDSeXdSiWeS (Sef.3/"sseNCling tPPLs).

SAFETY MESHES ASSEMBLING



Turn the fan up side down and insert the electric cable into the proper hole placed on the side panel.



Put the qty. 2 safety meshes guard (*ref.1.1/Body*) on the inlet side of the fan.



Fix the qty. 6 screws (*ref.7.13/Bolts&nuts*) on the fan side (qty. 3 for each side are required).



Fix the screws (*ref.7.13/Bolts&nuts*) with the QlastiD clips (*ref.7.14/Bolts&nuts*) in correspondence of the propeller central support on the top panel and the bottom panel.



Fix the screw with the washer (*ref.7.13/Bolts&nuts*) into the central pulley axle. Fix all the components by using the pneumatic screwdriver (*ref.3/Assembling tools*).

CE KIT ASSEMBLING



Before assembling the safety meshes complete the CE kit. Join the plastic safety protection for central pulley (*ref.8.1/Optional kits*) with plastic safety protection for the V-belt (*ref.8.2/Optional kits*).



Place the plastic safety protection for the motor pulley (*ref.8.3/Optional kits*) in the motor corner (make sure that the plastic square pins are inserted in the proper housing holes). Join the plastic safety protection for the motor pulley.

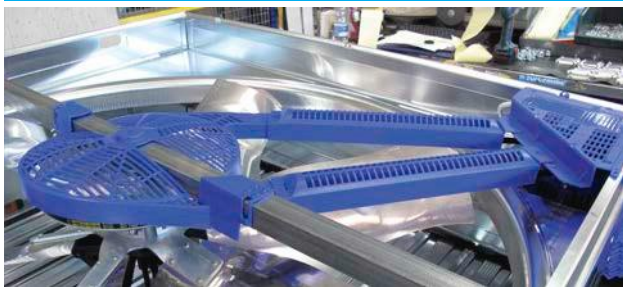

Put the assembled CE plastic kit protection (make sure that the groove of the plastic safety protection for the V-belt are centered along the V-belt). Follow the safety mesh guard assembling procedures and then fix the complete assembled you have obtained by mean of qty.1 screw (*ref.8.4/Optional kits*).

PYRAMIDAL SHAPE MESH ASSEMBLING



Put the pyramidal shape mesh (*ref.8.5/Optional kits*) on the fan as in the picture. The rectangular holes must be positioned horizontally.

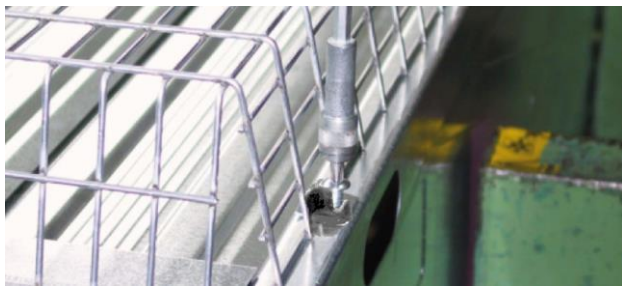

Fix it to the bottom and top panels by means of qty. 6 grey plastic clips and qty. 6 screws (*ref.8.6/ Optional kits*). The metal clips must be fixed in the position as in the picture.

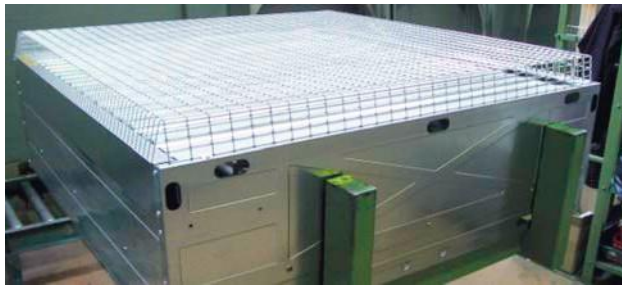

Fix it by using a pneumatic screwdriver (*ref.3/ Assembling tools*).

Munters EM50 extraction fan is developed and produced by Munters Italy S.p.A., Italy



www.munters.com

[Australia](#) Phone +61 2 8843 1594, agh.info@munters.com.au, [Brazil](#) Phone +55 41 3317 5050, contato@munters.com, [Canada](#) Phone +1 517 676 7070, aghort.info@munters.com, [China](#) Phone +86 10 8048 3493, marketing@munters.cn, [Denmark](#) Phone +45 98 623 311, aghort@munters.dk, [Germany](#) Phone +49 (0) 25 58 - 93 92-0, [India](#) Phone +91 20 6681 8900, info@munters.in, [Indonesia](#) Phone +66 2 642 2670, info@munters.co.th, [Israel](#) Phone +972 3 920 6200, info@munters.co.il, [Italy](#) Phone +39 0183 5211, info@munters.it, [Japan](#) Phone +81 3 5970 0021, mkk@munters.jp, [Korea](#) Phone +82 2 7618 701, munters@munters.co.kr, [Mexico](#) Phone +52 818 2625 400, dhinfo@munters.com, [Singapore](#) Phone +65 7 446 828, info@munters.com.sg, [South Africa and Sub-Sahara Countries](#) Phone +27 11 997 2000, info@munters.co.za, [Spain](#) Phone +39 0183 5211, info@munters.it, [Sweden](#) Phone +46 8 6266 300, info@munters.se, [Thailand](#) Phone +66 2 6422 670, info@munters.co.th, [Turkey](#) Phone +90 262 7513 750, info@muntersform.com, [USA](#) Phone +1 517 676 7070, aghort.info@munters.com, [Export & Other countries](#) Phone +39 0183 5211, info@munters.it

Munters reserves the right to make alterations to specifications, quantities, etc., for production or other reasons, subsequent to publication.

© Munters AB