

# Munters Saturn ONE Series

## Air extraction fans

The Saturn ONE series is a feature rich, high-tech, and completely modular series of fans, able to combine exceptional airflow with fully energy efficiency. This means superior growth of livestock and yield, improved animal welfare and more sustainable business.

### Benefits

- Fewer moving parts reduce maintenance time and costs
- Smooth inner housing edges increase airflow efficiency
- Reduced noise emission improves the indoor environment for animals
- Energy efficient ventilation system, saving up to 50% of electricity with the E-line version
- The patented detachable Anti-Gravity Shutter (AGS) reduces light, air leakage, dust deposit and noise

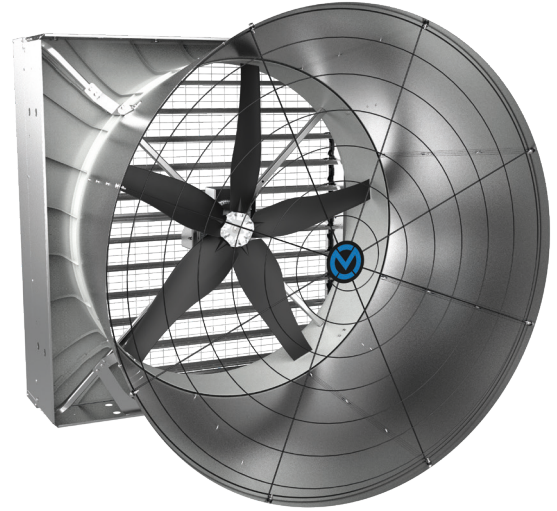

Saturn ONE Direct drive 5 blades

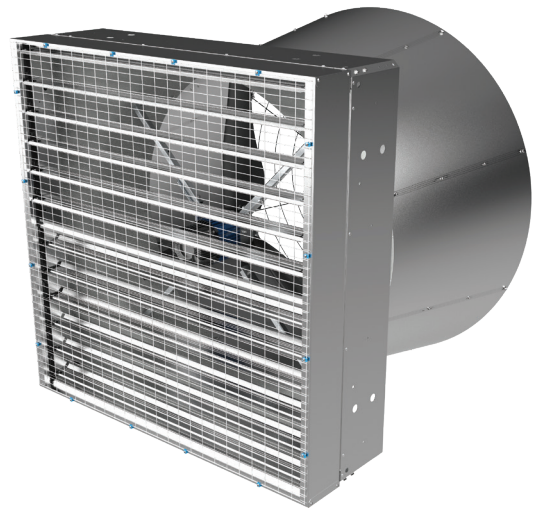

Saturn ONE E-line 3 blades – Patented Anti-Gravity Shutter (AGS)

Saturn ONE is designed for any poultry or greenhouse application in any climate zone.

The propeller blades are designed for optimal performance, providing exceptional airflow even in high-pressure environments with an excellent airflow ratio and efficiency. The patented AGS seals tightly eliminating the thread of light, air draft and dust deposit.

The E-line version ensures performance above the market standard and reduces power consumption by up to 50% compared to the same fan with AC motor, all while enabling speed regulation.

The VFD controller generates the most efficient rotation, installation is quick and easy, and a proportional gear motor optimizes the AGS operations.

As the market leader in ventilation solutions for more than 60 years, Munters guarantees quality and is ISO 9001 certified.

## Models

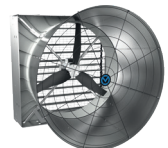
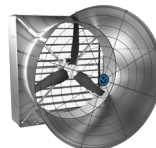
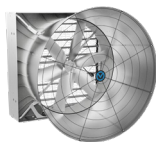
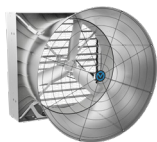

	Belt 1.5	Belt 2.0	Direct 2.0	E-line
Drive	Belt	Belt	AC, Direct	EC, Direct
Propeller	3 blades, Munters Protect	6 blades, Munters Protect	3/5 blades, composite	3/5 blades, composite
Nominal power	1.5 hp	2.0 hp	2.0 hp	3.0 hp
Application	Broiler, greenhouse (light filters cannot be used)	Layer houses with obstacles, Broiler mega houses, Light control (light filters) houses	Layer houses with obstacles, Broiler mega houses, Light control (light filters) houses, No maintenance	Any poultry, greenhouse in any climate zone No maintenance
Max static pressure	Up to 75 Pa	Up to 100 Pa	Up to 120 Pa	Up to 140 Pa

# Munters Saturn ONE Series

## AC motor

### Dimensions

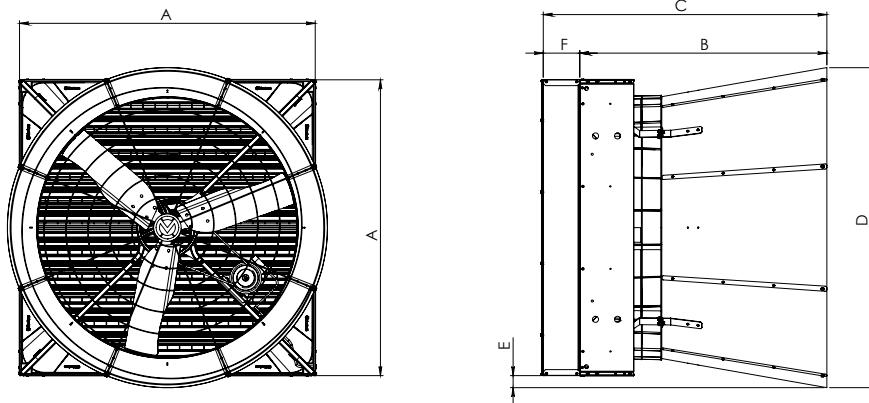

A	B	C	D	E	F
1615 mm	1345 mm	1518 mm	1745 mm	80 mm	173 mm

### Technical specifications

		Belt 1.5	Belt 2.0	Direct 2.0
Nominal power	hp	1.5	2.0	2.0
Propeller diameter	mm [inch]	1400 [55]	1400 [55]	1400 [55]
Number of blades/material		3/Munters Protect	6/Munters Protect	3/Composite 5/Composite
Motor/drive type		AC/Belt	AC/Belt	AC/Direct
Weight of fully equipped fan	kg	114	122	130 131
Max power consumption/max current <sup>1</sup>	W/A	1900/3.4	2350/4.3	2115/4.3 2460/4.7
Protective class of electric motor		IP55	IP55	IP55
Noise level <sup>2</sup>	Db(a)	75.3	76.9	77.7 78.9

<sup>1</sup>50 Hz 400 V specification, 60 Hz available upon request (not available with Direct drive 5 blades), <sup>2</sup>Noise measured according to ISO 3744

Airflow

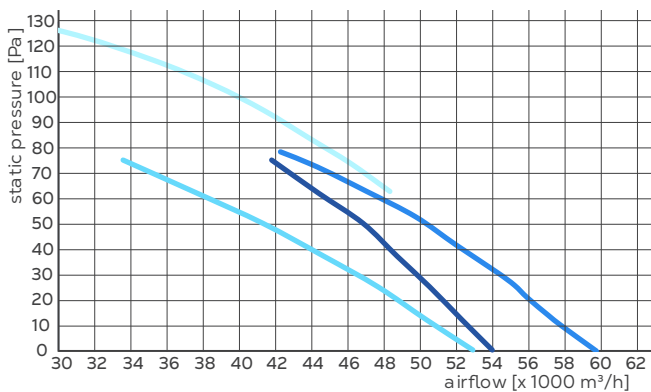

Efficiency

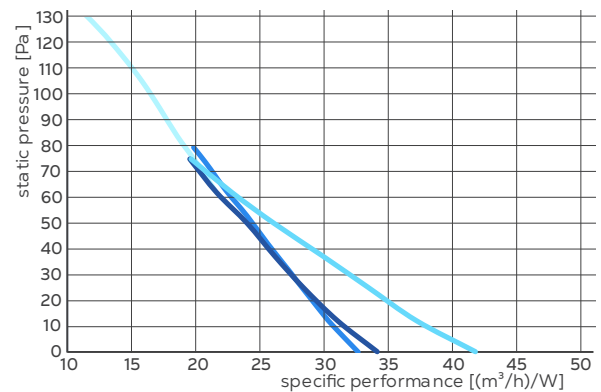

Belt 1.5		Belt 2.0		Direct 2.0	
Motor	BESS Lab	Motor	BESS Lab	Motor	Motor
— IE3 1.5 hp	#21109	— IE3 2.0 hp	#21113	— IE3 2.0 hp, 3 blades	— IE3 2.0 hp, 5 blades

Direct 2.0: airflow and efficiency tested in the Munters test chamber in accordance with ANSI/AMCA 210/15 Standard, certified by BESS Lab.

### Load capacity

	Belt 1.5		Belt 2.0		Direct 2.0	
	Unassembled	Assembled	Unassembled	Assembled	Unassembled	Assembled
40' HC container	132 (108 <sup>1</sup> )	25	120 (96 <sup>1</sup> )	25	72 (60 <sup>1</sup> )	21
13.6 m truck	-	31	-	31	-	26

<sup>1</sup>With square safety mesh

# Munters Saturn ONE Series

## E-line

### Dimensions

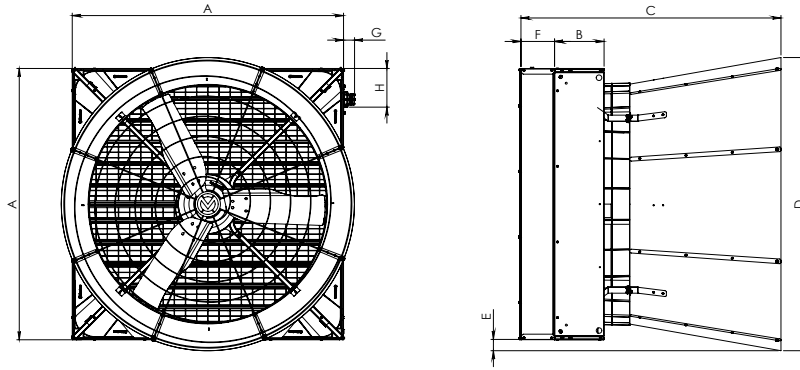

A	B	C	D	E	F	G	H
1615 mm	295 mm	1518 mm	1745 mm	80 mm	173 mm	65 mm	230 mm

### Technical specifications

		E-line	
Nominal power	hp	3.0	
Propeller diameter	mm [inch]	1400 [55]	
Nominal propeller speed	rpm	730	
Motor/drive type		EC/Direct	
Number of blades/material		3/Composite	5/Composite
Weight of fully equipped fan	kg [lbs]	120	121
Max power consumption/max current <sup>1</sup>	W/A	2400/4.5	2700/5
Max operating pressure	Pa	75	140
Protective class of electric motor		IP66	
Noise level <sup>2</sup>	Db(a)	79.2	80.9

<sup>1</sup>50 Hz 400 V specification, 60 Hz available upon request, <sup>2</sup>Noise measured according to ISO 3744

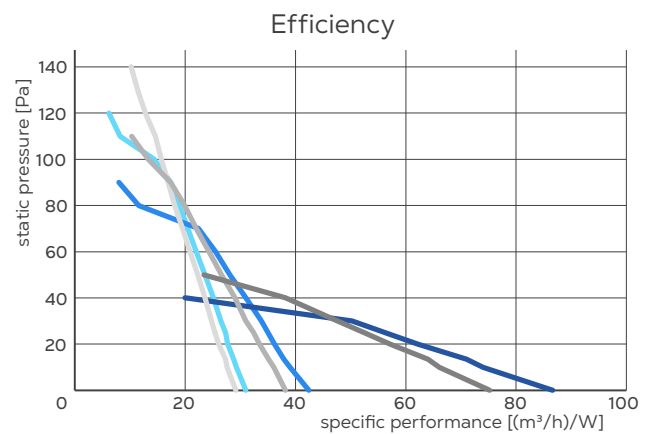
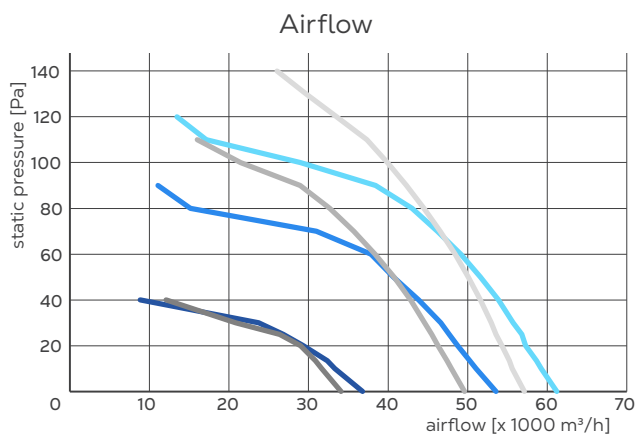

3 bl.: — 730 rpm, — 630 rpm, — 430 rpm; 5 bl.: — 730 rpm, — 630 rpm, — 430 rpm.

Airflow and efficiency tested in the Munters test chamber in accordance with ANSI/AMCA 210/15 Standard, certified by BESS Lab.

### Load capacity

	E-line	
	Unassembled	Assembled
40' HC container	72	21
13.6 m truck	-	26

Find your nearest Munters office at [www.munters.com](http://www.munters.com)

Munters reserves the right to make alterations to specifications, quantities, etc., for production or other reasons, subsequent to publication. © Munters AB, 2024