

Communicator

Manual for use and maintenance



Communicator

Communication System

Ag/MIS/UmGB-2567-04/18 Rev 1.0
P/N: 116048



Communicator

Manual for use and maintenance

Revision: N.1.0 of 03.2019

Ag/MIS/UmGB-2567-04/18 Rev 4.5 (MIS)

Product Software: Version 3.07

This manual for use and maintenance is an integral part of the apparatus together with the attached technical documentation.

This document is destined for the user of the apparatus: it may not be reproduced in whole or in part, committed to computer memory as a file or delivered to third parties without the prior authorization of the assembler of the system.

Munters reserves the right to effect modifications to the apparatus in accordance with technical and legal developments.

Index

<i>Chapter</i>		<i>page</i>
1	INTRODUCTION	6
1.1	Disclaimer	6
1.2	Introduction	6
1.3	Notes	6
2	BEFORE USING	7
3	INTRODUCTION TO THE COMMUNICATOR	8
3.1	Main features	8
3.2	Choosing communication cards	8
3.3	User interface	8
3.3.1	Front panel	9
3.3.2	Menu tree	9
4	INSTALLATION	11
4.1	Hardware Installation	11
4.1.1	Preliminary Steps	11
4.1.2	Connecting the unit to external components	13
4.1.3	USB Driver Installation	14
4.2	Connecting the Communicator to a Controller	14
4.2.1	Routing Methods	14
4.2.2	RS-232 Connections	15
4.2.3	RS-485 Connection	16
4.2.4	Approximate Distances and Baud Rate	17
4.3	Completing the Installation	18
4.3.1	Configuring the communication to outside devices	18
4.3.2	Communicator / Comm-Box Connectivity	18
5	INITIAL CONFIGURATION	20
5.1	Communication recommendations	20
5.2	Setting the test schedule	21
5.3	Setting the language	21
5.4	Setting the farm site name	21
5.5	Identifying the controllers	22
5.6	Setting the time & date	22
5.7	Adding names to the Address Book	22
5.7.1	Phone number structure	23
5.8	Setting the password	23

6	COMMUNICATOR TO USER FUNCTIONS	24
6.1	Voice functions	24
6.1.1	Basic voice functions	24
6.1.2	Advanced voice functions	25
6.1.3	Responding to an audio alarm message	27
6.2	Pager functions	28
6.2.1	Basic pager functions	28
6.2.2	Advanced pager functions	29
6.3	Text functions	29
6.3.1	Basic text functions	29
6.3.2	Advanced text functions	31
6.3.3	Text message responses	31
6.4	Common Functions	32
6.4.1	Test	33
6.4.2	Message Options	33
6.4.3	Hyper terminal	33
6.4.4	Monitor	33
7	COMMUNICATOR TO CONTROLLER FUNCTIONS	34
7.1	Network connection configuration	34
7.1.1	Configuring the channel settings	34
7.1.2	Displaying the controllers	35
7.1.3	Listing the network devices	35
7.2	Channel/Signal tests	35
7.2.1	Testing the RS-232/485 channel	36
7.2.2	Testing the Radio RF signal	36
8	COMMUNICATOR TO PC CONFIGURATION	37
8.1	Defining the communication speed with the local PC	37
8.2	Configuring the data connection	37
9	CONFIGURING THE DRY CONTACT CARD	38
10	COMMUNICATOR FUNCTIONS	39
10.1	Saving and restoring system settings	39
10.2	Test functions	39
10.2.1	Testing the backup battery	39
10.2.2	Viewing device status	40
10.2.3	Viewing the software and hardware version	40
10.3	Viewing relay settings	40
11	ALARMS	41
11.1	Introduction to alarms and responses	41
11.2	Event codes	42
11.3	Advanced alarm settings	42

11.3.1	Resetting the alarms	42
11.3.2	Disabling alarms	43
11.3.3	Defining the message delay	43
11.3.4	Defining the message repeat parameter	43
11.3.5	Defining the internal alarms	44
11.3.6	Defining the battery alarm	44
11.4	Alarm and events history	44
11.4.1	Displaying the alarm history	44
11.4.2	Displaying the user events	45
11.4.3	Displaying the system events	45
11.5	Testing the alarm backup batteries	45
11.5.1	Dial-Up test	46
11.5.2	Voltage test	46
12	TROUBLESHOOTING	47
12.1	Hardware	47
12.2	Communication to controllers/PC	47
12.3	Cellular modem	49
12.4	RF communication	50
12.5	Voice card	51
12.6	Alarm	52
12.7	Line modem	52
12.8	Battery	52
13	TECHNICAL DATA	53
14	APPENDIX A: REPLACING COMMUNICATION CARDS AND MODEMS	54
14.1	Replacing the RS-232 card	54
14.2	Replacing the RF-card	55
14.3	Installing a GSM-S or GSM-W card	56
14.4	Installing a 3G Cell Modem Card	56
15	APPENDIX B: COMMUNICATOR / CONTROLLER CONNECTIVITY	58
16	APPENDIX C: ETHERNET CARD/ROTEMNET SETUP	59
16.1	Setting Up an Internet connection	59
16.2	Setting Up a Network using RotemNet	60
16.2.1	Local network	60
16.2.2	Remote network	61
17	WARRANTY	62

1 Introduction

1.1 Disclaimer

Munters reserves the right to make alterations to specifications, quantities, dimensions etc. for production or other reasons, subsequent to publication. The information contained herein has been prepared by qualified experts within Munters. While we believe the information is accurate and complete, we make no warranty or representation for any particular purposes. The information is offered in good faith and with the understanding that any use of the units or accessories in breach of the directions and warnings in this document is at the sole discretion and risk of the user.

1.2 Introduction

Congratulations on your excellent choice of purchasing a Communicator!

In order to realize the full benefit from this product it is important that it is installed, commissioned and operated correctly. Before installation or using the fan, this manual should be studied carefully. It is also recommended that it is kept safely for future reference. The manual is intended as a reference for installation, commissioning and day-to-day operation of the Munters Controllers.

1.3 Notes

Date of release: May 2005

Munters cannot guarantee to inform users about the changes or to distribute new manuals to them.

All rights reserved. No part of this manual may be reproduced in any manner whatsoever without the expressed written permission of Munters. The contents of this manual are subject to change without notice.

2 Before using

The Communicator is the central communication center and provides critical alarm warnings.

THEREFORE IT IS CRITICAL THAT YOU CARRY OUT THE FOLLOWING MAINTENANCE CHECKS ACCORDING TO THE RECOMMENDED SCHEDULE:

1. Daily (minimum weekly) alarm tests. Refer to Setting the test schedule, page 20.
2. Monthly battery (minimum between flock) test.
 - Disconnect power to Communicator
 - Ensure Communicator transmits SMS and voice alarms.
 - Wait one hour, and confirm that Communicator continues to transmit alarms.
 - Restore power to Communicator.
3. Test the Alarm Backup Batteries monthly (refer to page 45).

WARNING! Communicator does not support pre-paid SIM cards. Use a regular card only!

CAUTION Use an exclusive phone line for the Communicator!

NOTE: Sometimes using a phone line via private switchboard might interfere with communication.
Munters recommends using a different line to the Communicator.

CAUTION As a backup to the Communicator, Munters recommends installing an Emergency Light and Siren system. If the Communicator is unable to transmit alarms via SMS or the telephone (for example there is a complete power failure), the Emergency Light and Siren system sounds an alarm.

3 Introduction to the Communicator

Munters Communicator, Version 3.06 is a state-of-the-art alarm and communication center used by farmers to monitor and control their Munters Controllers and accessories. The Communicator has a user friendly interface with an alpha-numeric keypad, 20 character by 4 line LCD and indicative LED.

- Choosing communication cards
- Main features
- User interface

3.1 Main features

- Supports connectivity of several contacts simultaneously on various communication devices (such as dial-up, internet, GSM, USB)
- Voice Solution Plug-in: Supports incoming and outgoing phone calls for alarms and status reports. Voice messages can be edited according to personal preference.
- Remote access via dial-up connection
- Send and receive functional text messages (GSM/3G networks)
- Pager support
- 3 dry contact, output relays 5 Amp
- 8 digital inputs
- Battery backup

3.2 Choosing communication cards

The Communicator supports the following cards:

- **Line modem:** Supplies remote communication and voice alarms via a phone line.
- **GSM-S/GSM-W:** Supplies text alarms and text messages only.
- **3G Cell Modem:** Supplies text alarms and text messages only.

NOTE: GSM cards do not support voice, but if equipped with a SIM card, they can support the Voice Dial-In function (Configuring the telephone modem, page 26).

NOTE: Use the GSM functions to set up a 3G Cell modem.

The Communicator has positions for two cards. Before ordering a unit, the user along with a dealer must define which cards meet his needs and are supported by local infrastructure.

3.3 User interface

The following sections detail how to access and use the Communicator user interface.

- Front panel, page 9
- Menu tree, page 9

3.3.1 FRONT PANEL

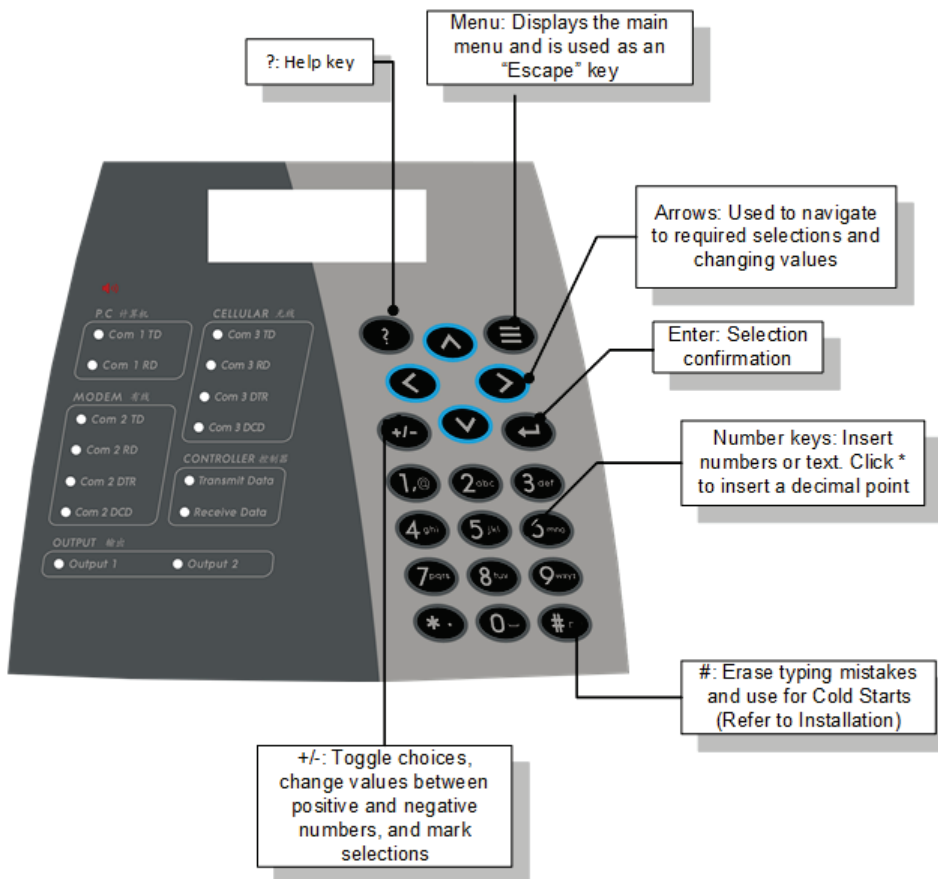

LED	Function
PC Com 1 TD/RD	PC is transmitting/receiving data to/from the Communicator
Modem Com 2 TD/RD	Modem is transmitting and receiving data
Modem Com 2 DTR/DCD	Data transmitter ready/Data carrier detect (technician only)
Cellular Com 3 TD/RD	Cellular modem is transmitting and receiving data
Controller Transmit Data Receive Data	Controller relays are transmitting and receiving data
Output 1 Output 2	Non-functional

3.3.2 MENU TREE

Table 1: Menus

My Farm	Alarm	History	System
Farm Name	Reset	Alarm	Test
Address Book	Test Schedule	User Events	Digital Input
Status Report	Disabled Alarms	System Events	Relay
Controllers	Options		Save / Resetting
Password			Language

My Farm	Alarm	History	System
Time & Date			Advanced Setup
			Technician Tools

Table 2: Sub Menus

Test		Save/Resetting	Advanced Setup
Battery	Signal Strength	Restore	Voice
GSM	Send Text MSG	Save	RF/Wired Network
Radio RF Signal	Dial Out		Battery
Hardware Profile			Internet
Wired RS232/485			COM/USB
Network List			Line Modem
Voice			GSM
Pager			Pager
Dial Out			

NOTE: Use the GSM functions to set up a 3G Cell modem.

4 Installation

The following sections detail how to install the Communicator.

CAUTION Munters recommends that only an authorized technician install and configure the Communicator unit.

- Hardware Installation 11
- Connecting the Communicator to a Controller, page 14
- Completing the Installation, page 18

4.1 Hardware Installation

The following sections detail how to perform the Communicator's physical setup.

- Preliminary Steps
- Connecting the unit to external components
- USB Driver Installation

4.1.1 PRELIMINARY STEPS

NOTE: Open the Communicator and verify that all required components are physically installed. Figure 1 illustrates a sample Communicator and its components.

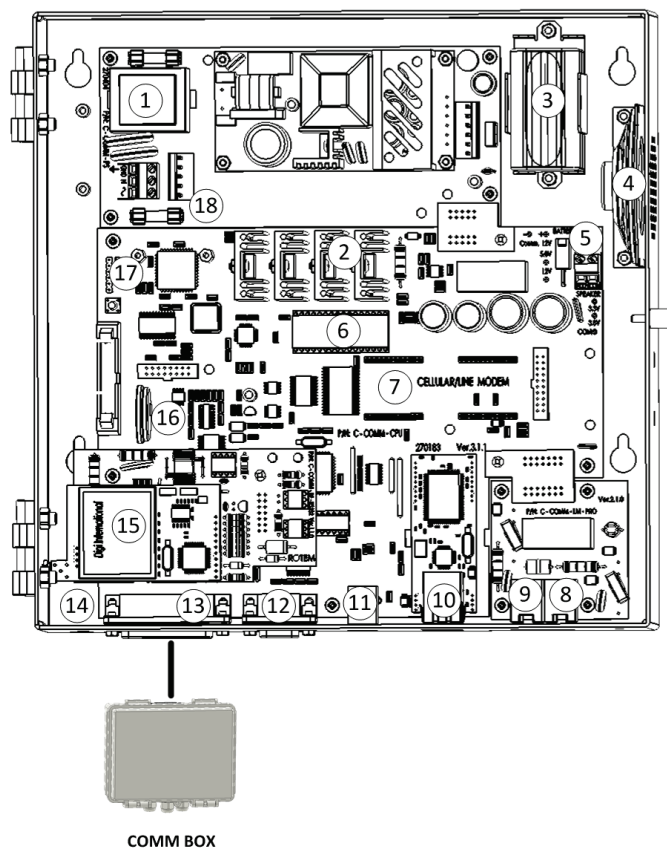

Figure 1: External Connection Box Connector and Internal Components (Sample) Board

Figure 1 key			
1	Power supply card	10	Ethernet Cable
2	Switching PS Main Fuse 2A	11	USB Local PC Port
3	Backup Batteries	12	PC Port
4	Speaker	13	External Connection
5	Battery Connector <ul style="list-style-type: none"> • (-) Black • (+) Red 	14	230 or 115 VAC
6	EPROM Software	15	Communication Card
7	Cell Modem	16	CPU battery
8	Phone port	17	Voice card
9	Line Port	18	12V Main Fuse 100 mA T

1. Connect the ground cable to the dedicated ground terminal (Figure 2).

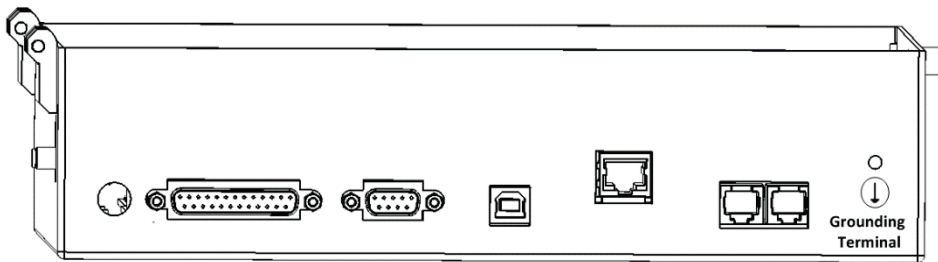

Figure 2: Grounding Terminal

CAUTION The Communicator must be grounded at all times!

2. Apply power while pressing  until the Cold Start screen appears.



3. Select YES.

NOTE: Cold Start resets the Communicator to original factory settings and erases previous history. Perform a Cold Start when installing new hardware, changing the software version, or if instructed by a Munters technician.

4. Go to SYSTEM > Test > Hardware Profile.

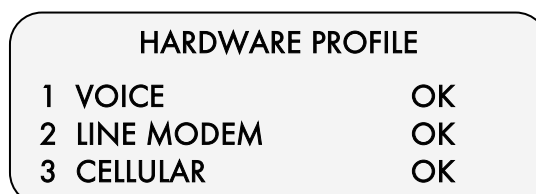

5. Ensure that Communicator recognizes the components.

6. Go to *SYSTEM > Test > Battery*.

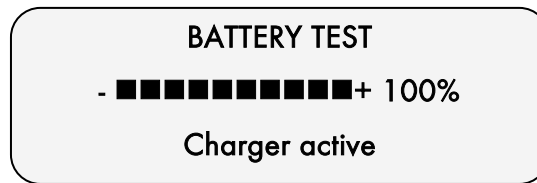

7. Check for battery recognition and charging. As long as the Communicator unit is plugged in, the charger inactive note is displayed.

8. Install the communication software using the accompanying CD (for installation instructions, refer to USB Driver Installation, page 14).

4.1.2 CONNECTING THE UNIT TO EXTERNAL COMPONENTS

1. Connect the External Connection Box to the Communicator using the 25 pin connector as shown in Figure 1.
2. If required, connect the External Connection Box to external devices and an ELS system (Figure 3).
3. Connect the local computer by via the PC Port or a USB cable.
4. Connect the line and phone cables.
5. Connect the ethernet cable to ethernet access point; for example an ADSL modem/router.

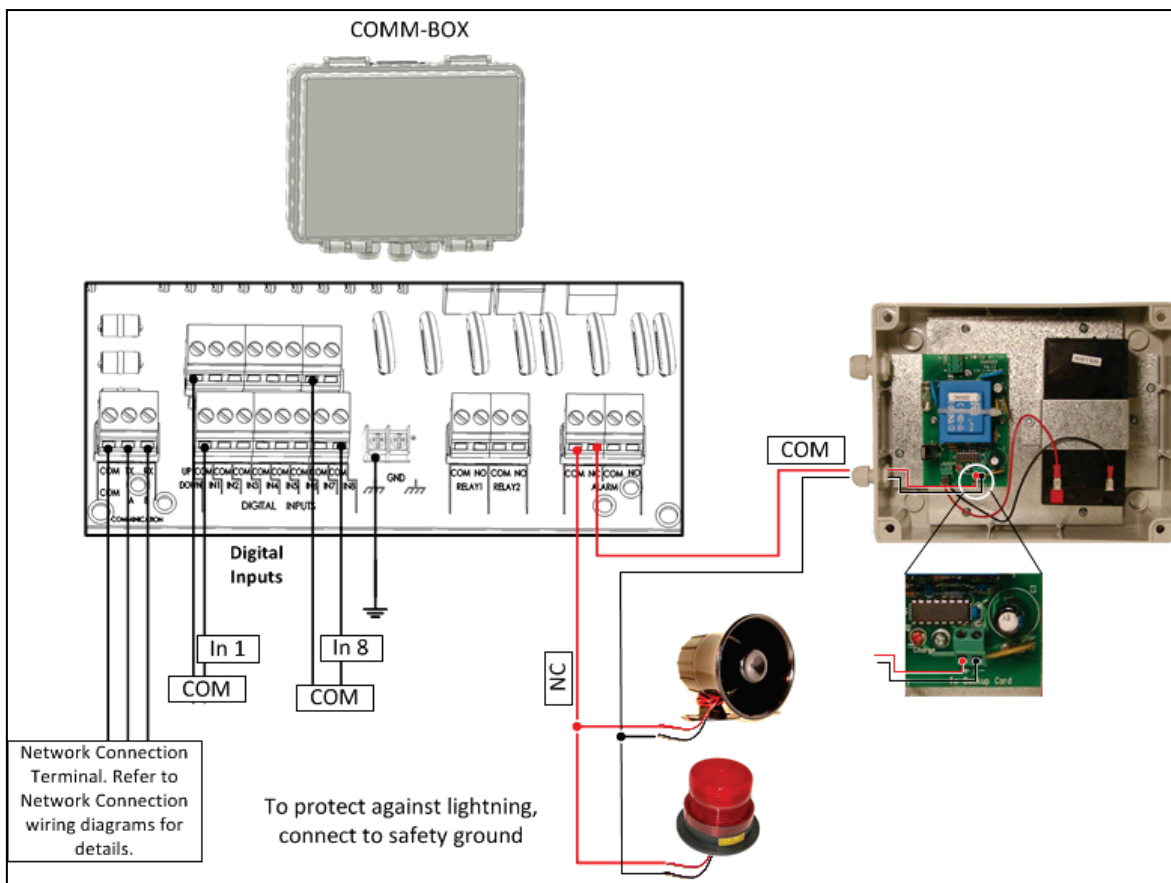

Figure 3: External Communication Box Wiring Diagram with ELS

4.1.3 USB DRIVER INSTALLATION

The following procedure details how to install R-USB Driver version 5.00. This driver must be installed before plugging in the USB cable between the host computer and the R-USB plug.

1. Ensure that the USB cable is disconnected from Communicator before installing the driver.

2. On the CD, click  .

3. Click .

4. Follow the instructions.

5. Restart the computer.

6. Connect a USB cable from the Communicator to the computer.

NOTE: *If older versions of the driver exist on the computer, the installation program must delete them. Click **Yes** if prompted.*

4.2 Connecting the Communicator to a Controller

The following sections detail how to connect the Communicator to the controllers via a wired or wireless infrastructure.

- Routing Methods
- RS-232 Connections
- RS-485 Connection
- Approximate Distances and Baud Rate

4.2.1 ROUTING METHODS

There are two common routing methods for running the communications connections; daisy chain and star connection.

- RS-485 infrastructure:
 - Daisy chain installations: No additional equipment required
 - Star installation: Requires a Munters RS-485 Repeater for each branch. Refer to the relevant manual for details
- Use RS-232 infrastructure:
 - Daisy chain or star installation: May require a Munters RS-232 Repeater to ensure signal strength, depending on the cable length and number of controllers installed. Refer to the relevant manual for details.

4.2.2 RS-232 CONNECTIONS

The following section details how to set up an RS-232 connection between the Communicator and the controllers.

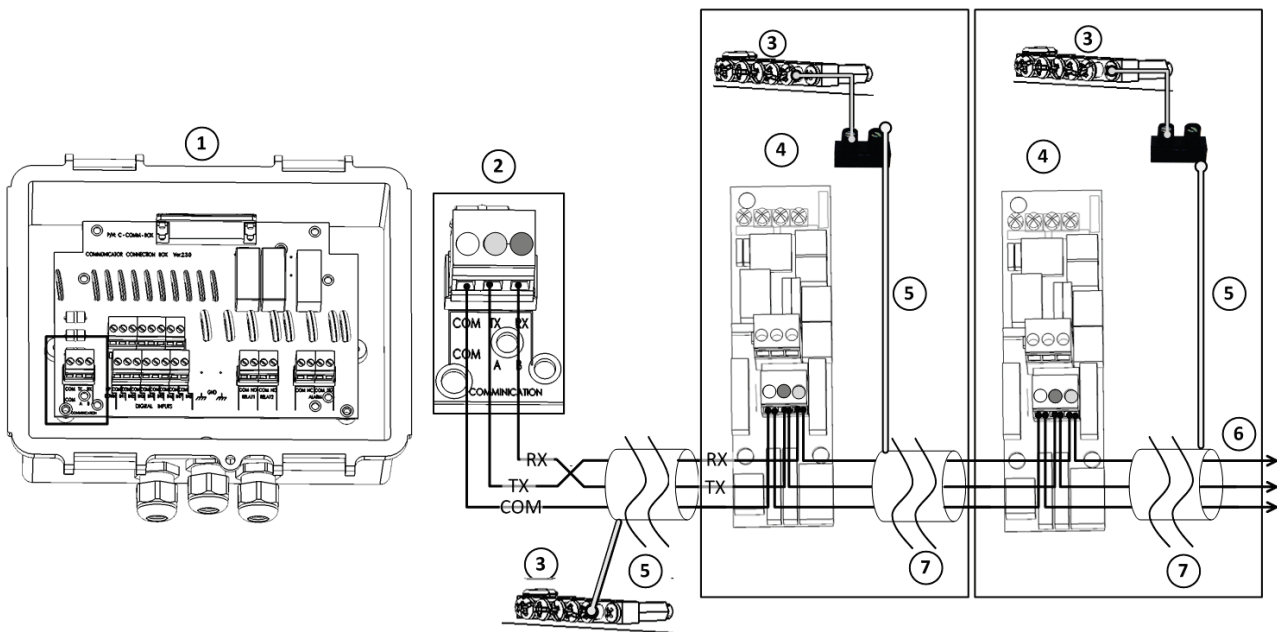

Figure 4: Connecting the External Connection Box to Controllers via RS-232 Cards

Figure 4 key			
1	Communicator External Box	5	Shield cable
2	Box communication ports	6	Other controllers
3	Connect one end of the cable's shield only. Each controller should be chain connected to the same wire, resulting in a long ground cable without ground loop	7	See Approximate Distances and Baud Rate, page 17
4	Controller communication card		

- The cable between the external connection box and the controllers should be a shielded cable (22 AWG).
- This cable is connected to all controllers and to the communication line of the external connection box in the following manner:
 - The COM wire is connected to the COM port in the communication terminal of the controller (green wire).
 - The Communicator External Box TX in the connection box is connected to RX in the controller (red wire).
 - The Communicator External Box RX in the connection box is connected to TX in the controller (black wire).
 - The shield should be connected to the earth (safety ground).

CAUTION Connect the shield (safety ground) only on one side!

4.2.3 RS-485 CONNECTION

The following section details how to set up an RS-485 connection between the Communicator and the controllers.

Communicator supports two types of RS-485 connections:

- RS-485 Cards (Figure 5)
- RS-ISO485 Cards (Figure 6)

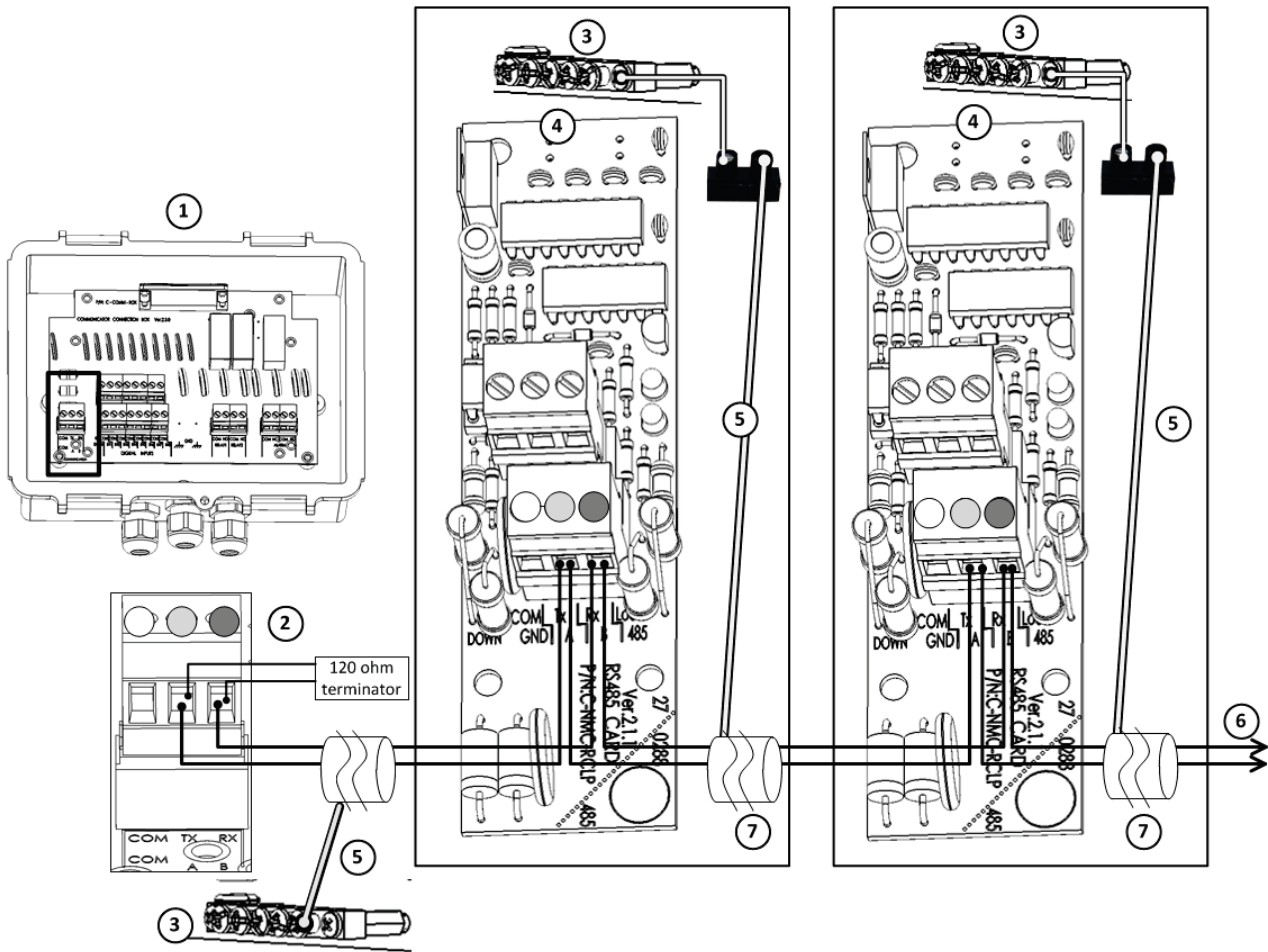

Figure 5: Connecting the External Connection box to Controllers via RS-485 Cards

Figure 5 / Figure 6 key			
1	Communicator External Box	5	Shield cable
2	Box communication terminal	6	Other controllers
3	To prevent ground loops, connect the shield wire at one end only.	7	See Approximate Distances and Baud Rate, page 17
4	Controller communication card		

- The cable between the external connection box and the controllers should be a 4 wire twisted shielded cable (22 or 24 AWG).
- Wiring:
 - Red wire to terminal A of the controller and terminal A of the external connection box.
 - Black wire to terminal B of the controller and terminal B of the external connection box.

- The final controller in any chain or branch requires a 120 ohm terminator.

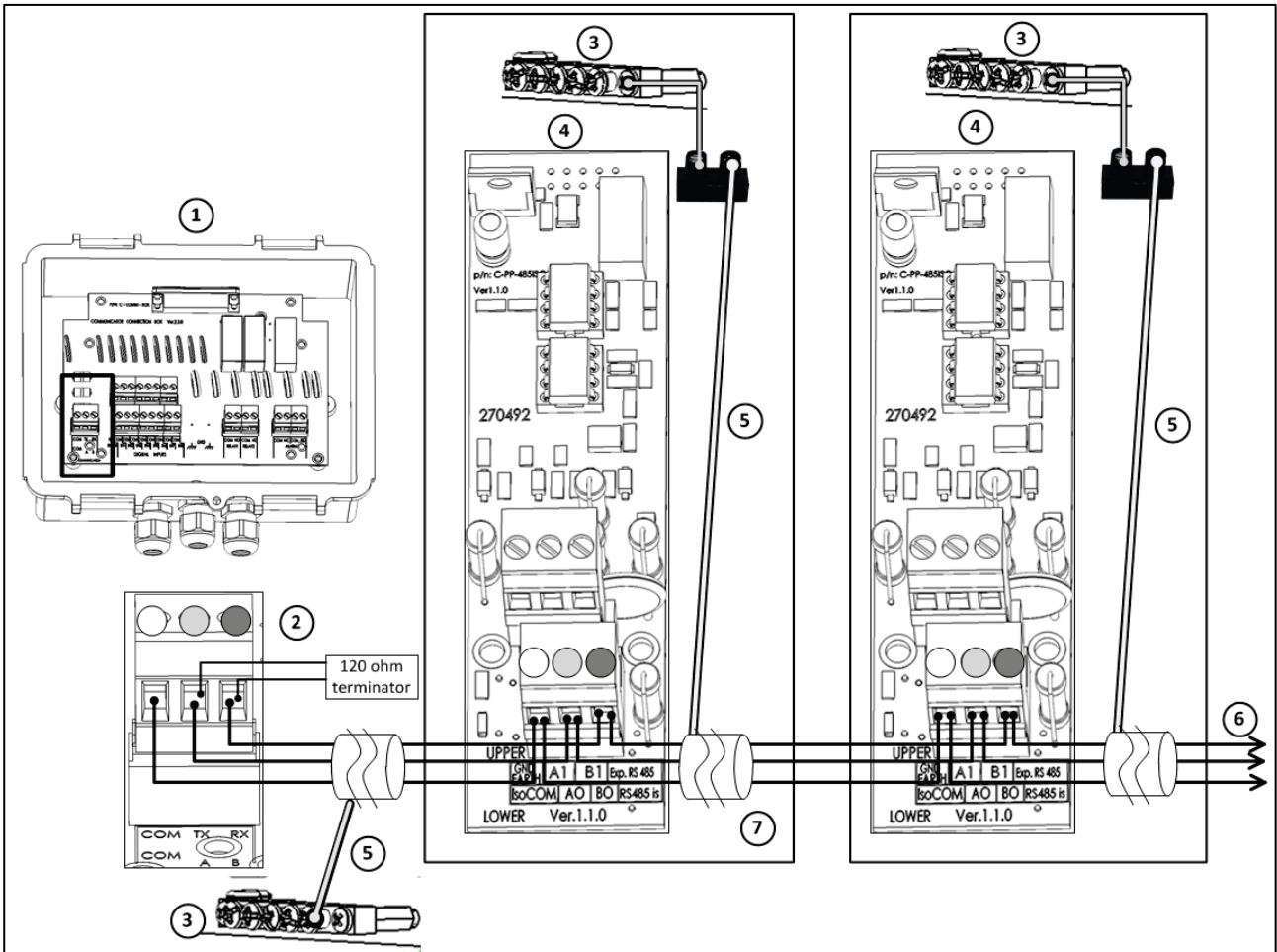

Figure 6: Connecting the External Connection box to Controllers via RS-ISO485 Cards

- The cable between the external connection box and the controllers should be a 4 wire twisted shielded cable (22 or 24 AWG).
- Wiring:
 - 1st pair:
 - Red wire to the controller's terminal A and the external connection box's terminal A.
 - Black wire to the controller's terminal B and the external connection box's terminal B.
 - 2nd pair:
 - Green wire to the controller's COM terminal and the external connection box's COM terminal.
- The final controller in any chain or branch requires a 120 ohm terminator.

4.2.4 APPROXIMATE DISTANCES AND BAUD RATE

- For one controller:
 - ~2000 meters (~6500 feet): 9600 Baud
 - ~2500 meters (~8200 feet): 4800 Baud
 - ~3000 meters (~9800 feet): 2400 Baud

- For 10 controllers:
 - ~1200 meter (~4000 feet): 9600 Baud
 - ~1800 meter (~6000 feet): 4800 Baud
 - ~2400 meter (~7870 feet): 2400 Baud

NOTE: Baud rate depends on cable length and on the number of controllers.

4.3 Completing the Installation

The following section summarizes the steps needed to complete the installation. Refer to the relevant sections in the manual for further details.

- Configuring the communication to outside devices
- Communicator / Comm-Box Connectivity

4.3.1 CONFIGURING THE COMMUNICATION TO OUTSIDE DEVICES

1. Set the baud rate to the controllers (refer to Configuring the channel settings, page 34).
2. Test the connection to each controller (refer to Displaying the controllers, page 35).
3. Test the communication channel to each controller (refer to Channel/Signal tests, page 35).
4. Set the baud rate to the local computer (refer to Defining the communication speed with the local PC, page 37).

4.3.2 COMMUNICATOR / COMM-BOX CONNECTIVITY

NOTE: Users having an Ethernet card – refer to Appendix C: Ethernet Card/RotemNet Setup, page 59.

- Communicator Software **Version 3.07.01** supports the Comm-Box. Download the software from the Munters web site.
- Connect the Comm-Box to a Munters Communicator using RJ11 cable and the D9-RJ11 adapter (supplied by Munters). Communicator units require the Communicator Serial Card (P/N: C-COMM-SERIAL / 904-99-00038) to support the Comm-Box.

WARNING! Disconnect the power before beginning.

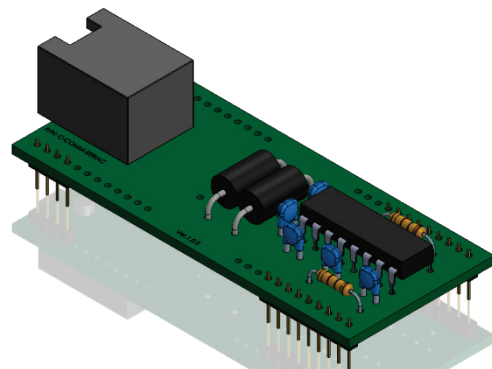
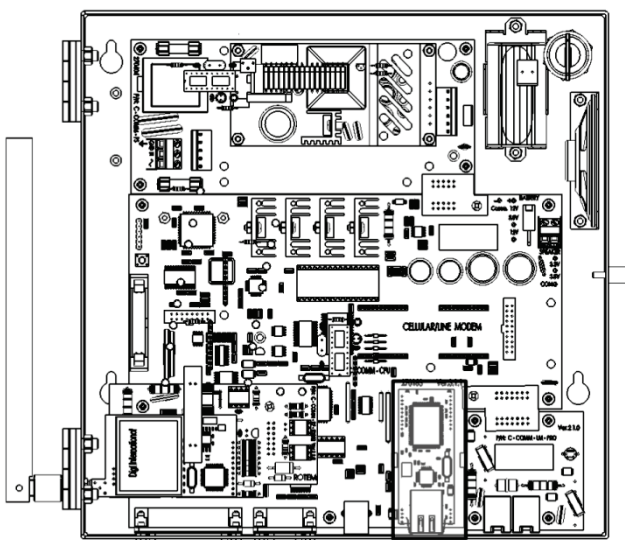

1. Lift and remove the Communication Card.

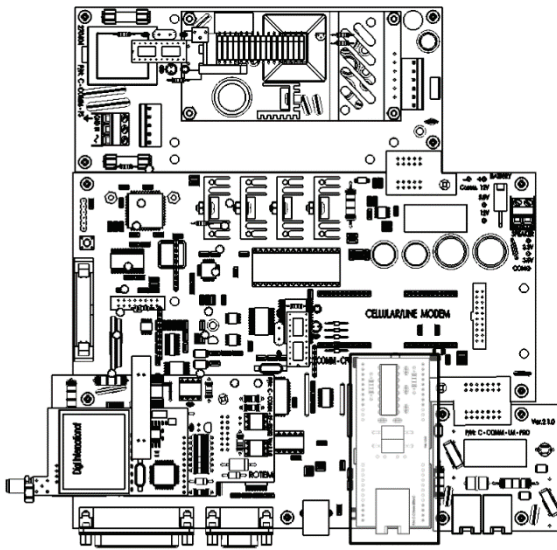

Figure 7: COMM-SERIAL

CAUTION Verify that the card is set exactly in place! Any deviation can severely reduce the card's functionality.

2. Snap the COMM-SERIAL card into place.



3. Connect the Communicator to the Comm-Box.

NOTE: Refer to the Comm-Box Manual for information on how to define and configure the Comm-Box and RotemNet Web application.

5 Initial configuration

This section describes how to configure the Communicator's initial settings.

- Communication recommendations, page 20
- Setting the test schedule, page 21
- Setting the language, page 21
- Setting the farm site name, page 21
- Identifying the controllers, page 22
- Setting the time & date, page 22
- Adding names to the Address Book, page 22
- Setting the password, page 23

CAUTION *Many of these settings are critical in ensuring the safety and well-being of your stock. These settings must be made as soon as Communicator is installed.*

Refer to the sections listed below for information on other functions:

- Communicator to user functions, page 24
- Communicator to controller functions, page 34
- Communicator to PC configuration, page 37
- Configuring the dry contact card, page 38
- Communicator functions, page 39
- Alarms, page 41

NOTE: *Before installing a SIM card, disable the PIN code (if the card has this code). Communicator text functions are disabled if the SIM card has a PIN code.*

5.1 Communication recommendations

Munters strongly recommends:

- enabling both the telephone and SMS functions to transmit alarms (via voice and SMS)
- enabling SMS alarm acknowledgment
- employing a secondary alarm system to act as a backup to Communicator's primary monitoring and alarm system

WARNING! *Because of limitations built into SMS delivery systems, there may be delays in the actual SMS delivery time. By default a reminder SMS is transmitted after two minutes. If the message delivery is delayed for any reason, including delays caused by the infrastructure, a reminder SMS is sent. Therefore increasing the delay time for a reminder places your livestock at risk.*

5.2 Setting the test schedule

1. Select **ALARM** > *Test Schedule*.
2. Configure the parameters.

ALARM TEST	
FREQUENCY	DAILY
AT	12:00

- **Frequency:** Daily, weekly, disabled
- **At:** Time of day to perform the alarm test
- **Day:** Define the day of the week to perform the alarm test (*this is required only when FREQUENCY=WEEKLY*)

WARNING! *Munters strongly recommends regular testing of the alarms. Do not disable this test unless the house is empty!*

5.3 Setting the language

1. Select **SYSTEM** > *Language*.
2. Configure the parameters.

LANGUAGE	
LANGUAGE	ENGLISH
REGION	US

- **Language:** Select the required language for the user interface.
- **Region:** Select the site location.

CAUTION *Select the correct region! The modem functions correctly only when the correct region is selected!*

5.4 Setting the farm site name

- Select **MY FARM** > *Farm /Site Name*.

FARM/SITE NAME	
NAME:	
NUMBER:	

Define the site's name and reference number. PC network software employs these parameters when sending an alarm. In case several Communicators are present, this will help in identifying each one separately.

CAUTION *Each Communicator **must** have a **unique** name and number.*

5.5 Identifying the controllers

1. Select *MY FARM > Controllers*.
2. Identify controllers that are present within the network.

CONTROLLERS			
PRIMARY UNITS			1
SECONDARY			0
FOUND-PRIM	0	Sec	0

- **Primary Units:** Select the number of master controllers the site contains (for example Platinum /AC-2000)
- **Secondary Units:** Select the number of slave controllers the site contains (for example Pig Guard)
- **Found-Primary/Secondary:** Displays the number of controllers the Communicator was able to locate (*read-only*)

5.6 Setting the time & date

1. Select *MY FARM > Time & Date*.
2. Adjust the time and date in this menu.

TIME&DATE	
CLOCK:	12:18
DATE:	07-FEB-10

- **Clock:** hh:mm: (24 hour format; for example 2:15 PM = 14:15)
- **Date:** dd-mmm-yy: (for example 14-JAN-10)

5.7 Adding names to the Address Book

- Select *MY FARM > Address Book*.

ADDRESS BOOK	
=====USER-2=====	
NAME	John Smith
VOICE	9,555555
TEXT	9005555554
PAGER	9,555555,,,
Msg By	idle
FROM	00:00
TO	0:00
LANG.	English

The address book contains the contact information of up eight users. Communicator contacts these users in the event of an alarm. Priority of contacts is defined by the user number (1-16). Top priority contacts should be entered into the address book first.

CAUTION Munters strongly recommends entering contact information immediately.

Contact list fields:

- **Name:** Enter the contact name using the keypad.
- **Voice:** Enter the phone number for receiving the **VOICE CALL** service (refer to Setting the voice , page 24 and Testing the voice call service, page 25 for advanced settings and testing).
- **Mobile NUMBER:** Enter the mobile number for the text message service.
- **Pager:** Enter the pager phone number. Refer to Pager setup, page 28 for options and testing. In addition, refer to Configuring the dial delay, page 29.

NOTE: *When entering the above numbers, refer to Phone number structure, page 23.*

- **Msg By:** Define which services the contact receives (*Idle, Voice, Text, Voice+Text, Pager*).
- **From/To:** Time frame for receiving messages/calls (*Default – FROM: 0:00; TO: 00:00 – time frame is 24 hours, meaning always receiving messages*).
- **Language:** Select the language in which SMS messages are written: *English, Turkish, Russian, Spanish, Thai or Hebrew*.

NOTE: *Distribution of the alarm messages is according to the address book list, contact by contact. Each user receives all forms of communication that are selected (**Msg. By** option) before continuing to the next user.*

The first user does NOT have a "FROM" or "TO" field to ensure there is always someone that receives the notification from Communicator.

5.7.1 PHONE NUMBER STRUCTURE

When entering the voice, mobile and pager numbers the phone number structure is:

- 9 (outside line, if needed), # # # # # # #,,

The commas are the dial delay. Refer to Configuring the dial delay, page 29.

NOTE: *To enter a comma, press and hold the "1" button.*

5.8 Setting the password

1. Select *MY FARM > Password*.
2. Define a password and confirm it (*to disable, type "0"*).



If selected, a password is required for:

- **Locally:** Using the menu items
- **Remotely:** Acknowledge/disabling of alarms via phone

NOTE: *If a password is defined, the Communicator locks the system when idle for five minutes or if you press "9" from the main menu.*

6 Communicator to user functions

The following sections detail how to use the:

- Voice, page 24
- Pager, page 28
- Text, page 29
- Common Functions , page 32

6.1 Voice functions

The following sections detail Communicator's basic and advanced Voice functions.

- Basic voice functions, page 24
- Advanced voice functions, page 25
- Responding to an audio alarm message, page 27

6.1.1 BASIC VOICE FUNCTIONS

This section details the basic Voice functions.

- Setting the voice parameters, page 24
- Testing voice quality, page 25
- Testing the voice call service, page 25
- Testing the cellular signal strength, page 25
- Receiving a status report, page 25

6.1.1.1 Setting the voice parameters

1. Select **SYSTEM** > *Advanced Setup* > *Voice*.

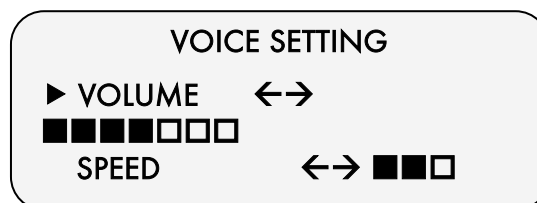

2. Define the speech **VOLUME** and **SPEAKER** volume and it's **SPEED** (if using a TTS voice card).
3. Scroll down to **TEST** and press **ENTER** to hear the selected settings.

6.1.1.2 Testing voice quality

1. Select **SYSTEM > Test > Voice**.
2. Define speech **VOLUME** and **SPEED**.
3. To test, press **ENTER**.

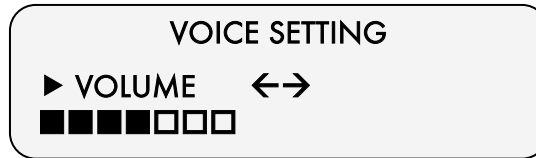

NOTE: *Voice Setting and Test Voice perform the same functions.*

6.1.1.3 Testing the voice call service

This menu tests the **VOICE CALL** service.

1. Select **SYSTEM > Test > Dial Out**.
2. Enter the required phone number to receive the "Test Call".
3. Press **ENTER**.

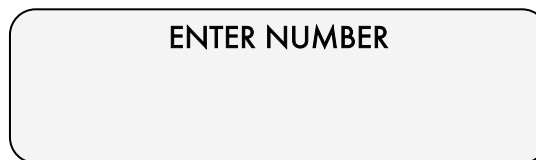

6.1.1.4 Testing the cellular signal strength

- Select **SYSTEM > Test > GSM/CDMA**.



This screen displays the cellular service provider's Received Signal Strength Indicator. This screen displays the cellular service provider's number, name, BER (Bit Error Rate (if available)), the reception bar graph as well as the measured signal reading.

NOTE: *Signal strength must be between -113 dBm to -51 dBm.*

6.1.1.5 Receiving a status report

You can receive a status report over the phone. Refer to Status report, page 30 for details on the function.

To hear the status report:

1. Call the Communicator phone number.
2. When prompted, select Status report.

6.1.2 ADVANCED VOICE FUNCTIONS

This section details Communicator's advanced Voice functions.

CAUTION *Munters recommends that only trained, authorized technicians configure these functions.*

- Configuring the telephone modem, page 26

- Defining when Communicator answers incoming calls, page 26

6.1.2.1 Configuring the telephone modem

- Select *SYSTEM > Advanced Setup > Line Modem*.

This screen defines the line modem specifications.

LINE MODEM	
AUTO ANSWER	4
LINE TEST	YES
DIAL DELAY (,)	2
INPUT GAIN	70
VOICE DIAL-IN	YES

- **Auto Answer:** Number of rings before the Communicator automatically answers a dialed-in call. For example: if set to **4** the Communicator answers a call after four rings.
- **Line Test:** Monitors the phone line and activates an alarm in case of disconnection. Default: YES.
- **Input Gain:** For factory use only. If your Communicator is unable to connect your voice dial in phone line, consult your local dealer regarding this feature.
- **Voice Dial-In:** This option enables the user to call in at any time and receive information from the Communicator regarding alarms. To receive the information in voice mode only:
 1. Call the controller, wait for one ring less than the AUTO ANSWER set parameter number and hang up.
 2. Wait at least five seconds (but no longer than 60 seconds) and then call again. Follow the instructions given by the controller.
 - If the AUTO ANSWER parameter is set to zero (0), then the Communicator answers in voice mode.
 - If the AUTO ANSWER parameter is set to zero and the VOICE DIAL IN parameter is set to **YES**, the controller answers in voice mode every time.

6.1.2.2 Defining when Communicator answers incoming calls

1. Select *SYSTEM > Advanced Setup > GSM/CDMA*.
2. In Auto Answer, define the number of rings until the Communicator answers through the cellular modem.

CELLULAR MODEM	
TEXT FROM	Addr. Book
Auto Answer	2
Operator	STD

6.1.3 RESPONDING TO AN AUDIO ALARM MESSAGE

The Voice Dial Out service transmits audio alarm message, via telephony, from Communicator to the contacts entered in the Address Book (page 22). This section details the procedure to follow when an audio alarm is received.

NOTE: This service is provided by the Communicator ONLY if the Address book is properly defined with contacts and the "VOICE" service selected per contact.

CAUTION Communicator only broadcasts its alarm message AFTER someone speaks into the phone. Any word or sound is sufficient.

The following illustrates the sequence of **ALARM messages**:

"Good <Morning / Afternoon / Evening> farm <#> active alarm.

Please, press 1 to listen."



"House <#> has <#> alarm message<s>."

- Alarm messages for the first house are played and then the following options are available:



Acknowledge



Replay house message



Play next house message



End call



- Enter password (if acknowledging for the first time this call) and press *.
- "Please wait... Reset for house <#> successful. <Next Message / Goodbye>."
- Right after "Please wait" is heard, press * to access the ALARM OPTIONS MENU.

"Entering alarm options for House <#>"

- System reports alarm and then offers the following options:



Disable

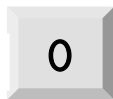

Return to house messages



Replay alarm message



Next alarm message

NOTE: Disabling alarms disables them until 12:00 PM the following day.

- "Disable <confirmed / failed>!" message is repeated and returns to **House Alarm Messages**

NOTE: If at any time an incorrect key is pressed or if nothing is pressed, the system repeats itself three times and then ends the call.

NOTE: To change the number of times that Communicator retries to contact a recipient, refer to Message Options, page 33.

6.2 Pager functions

The following sections detail the Communicator's basic and advanced Pager functions.

- Basic pager functions, page 28
- Advanced pager functions, page 29

6.2.1 BASIC PAGER FUNCTIONS

This section details the basic Pager functions.

- Pager setup
- Pager test

6.2.1.1 Pager setup

1. Select **SYSTEM** > **Advanced Setup** > **Pager**.
2. Define the pager type, either **BASIC** or **ENHANCED**, by using the +/- key.



- **Basic:** Pages are per house in the following format:

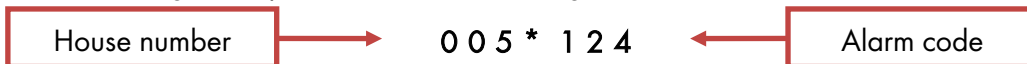

NOTE: If a house has more than one alarm active, then the multiple alarms code is sent (code: 255).

- **ENHANCED:** Pages are per house and can contain multiple alarms per page in the following format:

HHH*AAA*AAA*AAAHHH*AAA*AAA**

- HHH: House number (two stars separate between houses)
- AAA: Alarm code

6.2.1.2 Pager test

1. Select **SYSTEM** > **Test** > **Pager**.
2. Enter the pager phone number and press **ENTER**.



This feature tests the **PAGER** service. The pager number should include a dial delay. When dialing a pager service, there is usually a delay between the moment when the call is answered and when the message is recorded. For example: "Leave a message for Mr. Smith" takes about three seconds. The Dial Delay parameter is the amount of time that Communicator waits before transmitting its pager alert. Refer to Configuring the dial delay, page 29 for more information. Delay is also required when dialing for an outside line.

For example: If the required delay is three seconds and delay is set to two seconds, then two commas are required. The phone number structure is:

- 9 (outside line, if need), ###-####,,

NOTE: To enter a comma, press and hold the “1” button.

6.2.2 ADVANCED PAGER FUNCTIONS

The following section details the advanced Pager functions.

6.2.2.1 Configuring the dial delay

- Select *SYSTEM > Advanced Setup > Line Modem*.

When dialing a pager service, some services require additional tone menu browsing (interactive voice response). Use this feature to set a delay between the phone number and the tone browsing. Each “,” represents the number of seconds in delay between the phone number and the next browsing number. Refer to *Pager test*, page 28 for more information.

6.3 Text functions

The following sections detail the Communicator basic and advanced Text functions.

- Basic text functions, page 29
- Advanced text functions, page 31
- Text message responses, page 31

6.3.1 BASIC TEXT FUNCTIONS

The following sections detail the basic Text functions.

- Testing the text function, page 29
- Testing the SMS ringtone, page 30
- Status report, page 30

6.3.1.1 Testing the text function

This menu enables testing the text function.

1. Select *SYSTEM > TEST > GSM/CDMA > SEND TEXT MSG*.

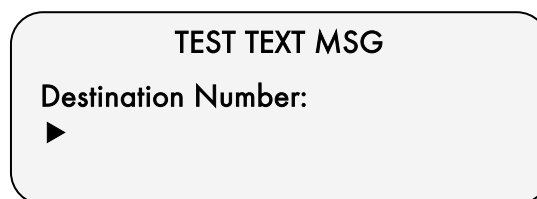

The image shows a screenshot of a menu titled "TEST TEXT MSG". Below the title is a label "Destination Number:" followed by a right-pointing arrow cursor, indicating an input field for a mobile phone number.

2. Enter in the required mobile phone number to receive the “Test Text” and press ENTER.
3. Confirm that the mobile phone received the following text message:
“Your Communicator is ready to send alerts via text messages.”

6.3.1.2 Testing the SMS ringtone

This menu tests the **SMS ringtone** service.

1. Select *SYSTEM > Test > Dial Out*.
2. Enter the required phone number to receive the "Test Call".
3. Press **Enter**.



6.3.1.3 Status report

Upon a user request, Communicator sends a status report on basic house functions and animal statistics. The report includes the following specifications:

- Target Temp
- Average Temp
- Vent Level
- Vent Mode (minimum ventilation, natural, tunnel)
- Humidity
- Weight (current average animal weight)
- Pressure (static pressure)
- Water Control (daily water consumption)
- Feed Count (daily feed consumption)
- Mortality

By default, the report only includes Target Temp, Average Temp, Vent Level and Humidity.

To select the parameters:

1. Select *SYSTEM > Advanced Setup > GSM/CDMA*.
2. Use the +/- key to select the required parameter.
3. Press **Enter** to select/deselect the parameter.
4. Press Save.

The parameters are configured.

To receive a status report:

- **Receiving the Report for One House**

☎SX > 'Send SMS' to the Communicator cell phone number.

☎ = Start of message

S = Status report

X = Represents house number (can be any positive number from 1 - 64)

- **Receiving the Report for Several Houses**

☎SX#X#X > 'Send SMS' to the Communicator cell phone number

☎ = Start of message

S = Status report

X = Represents house number (can be any positive number from 1-64)

= Sign separates between every house number

6.3.2 ADVANCED TEXT FUNCTIONS

The following sections detail the advanced Text functions.

- Defining who can text Communicator
- Configuring an SMS ringtone

6.3.2.1 Defining who can text Communicator

1. Select SYSTEM > Advanced Setup > GSM/CDMA.

CELLULAR MODEM	
TEXT FROM	Addr. Book
TEXT PRECALL	Yes/No
PRECALL TIME	5
Auto Answer	2
Operator	STD

This menu defines which cell phones can send messages to the Communicator via text.

2. In the *Text From* field, choose:

- **Addr. Book** (only those addresses which are text enabled) or
- **Any** (enables sending text via any cell phone).

NOTE: Acknowledgement messages are only sent when *Addr. Book* is selected.

6.3.2.2 Configuring an SMS ringtone

If desired, a ringtone can play when an SMS message from Communicator arrives, thereby alerting you of an upcoming message.

1. Select SYSTEM > Advanced Setup > GSM/CDMA.
2. In the Text Precall field, select **Yes**.
3. In the Precall time, enter the time (in seconds). This parameter ensures that there is sufficient time for the phone to ring before the SMS tone plays.

6.3.3 TEXT MESSAGE RESPONSES

2.0

Event codes, page 42 lists the events corresponding to the codes sent in a text message.

- Resetting the siren, page 31
- Resetting the alarm, page 32
- Acknowledging a message, page 32

6.3.3.1 Resetting the siren

NOTE: After typing the text message, press the 'Send' button to send it to the Communicator.

In the procedures below, the **highlighted text** shows the SMS text to be sent.

- **Resetting the Siren of One House**

IRX > 'Send SMS' to the Communicator cell phone number.

! = Start of message

R = Reset

X = Represents house number (can be any positive number from 1-64)

- **Resetting the Siren of Several Houses**

IRX#X#X > 'Send SMS' to the Communicator cell phone number

! = Start of message

R = Reset

X = Represents house number (can be any positive number from 1-64)

= Sign separates between every house number

- **Resetting the Siren for All Houses**

IRALL > 'Send' to the Communicator cell phone number

! = Start of message

R = Reset

ALL = Can be typed both in capital letters or small letters.

6.3.3.2 Resetting the alarm

To reset all the alarms, send the following text message:

IC > 'Send' to the Communicator cell phone number

! = Start of message

C = Communicator

6.3.3.3 Acknowledging a message

If [Message Repeat](#) is enabled (refer to page 43), Communicator continues to send alarms until an acknowledgement is sent.

- **Requesting a Response for Every Sent Text Message**

IAON > 'Send' to the Communicator cell phone number

! = Start of message

A = Acknowledgement

- **Canceling a Response for Every Sent Text Message**

IAOFF > 'Send' to the Communicator cell phone number

! = Start of message

A = Acknowledgement.

6.4 Common Functions

The following sections detail the technician tools.

- Select *SYSTEM > Technician Tools*.

TECHNICAL TOOLS	
TEST	4
HYPER TERMINAL	YES
MONITOR	2

This menu provides testing tools used by an **authorized** technician only.

- Test
- Message Options

6.4.1 TEST

- **Phone Line:** Measures the line voltage.
- **Internet:** (TBD).
- **Relays:** Toggle Relays 1, 2 and Alarm relay status by pressing ENTER.
- **Digital Input:** Displays the status of the eight digital inputs.
- **Memory:** Performs EEPROM test by pressing the MENU key.
- **Keyboard:** Tests the functionality of each key. Test keys by pressing them and verifying visually that the right key is displayed on the screen.

6.4.2 MESSAGE OPTIONS

This parameter specifies the number of times Communicator places a call to a recipient (until the recipient presses "1").

- Under Call ACK Retries, enter the required numbers.
 - **Range:** 1 - 10 (Default: 3)

6.4.3 HYPER TERMINAL

This is a dedicated function for system integrators ONLY!

6.4.4 MONITOR

TBD

7 Communicator to controller functions

The following sections detail how to configure the connections between Communicator and the controllers (local communication).

- Network connection configuration, page 34
- Channel/Signal tests, page 35

7.1 Network connection configuration

The following sections detail how to configure the baud rate and communication between the Communicator and its subunits. Communication can be via RS-232, RS-485, or RF.

- Configuring the channel settings, page 34
- Displaying the controllers, page 35
- Listing the network devices, page 35

7.1.1 CONFIGURING THE CHANNEL SETTINGS

- Select *SYSTEM > Advanced Setup > RF/Wired Network*.

SERIAL PORT	
BAUD RATE	9600
CHAN(6-7-8)	□□□
ADDR(4-5)	□□

This menu defines data rate and settings between the Communicator and its subunits.

NOTE: *This menu does **not** define the data rates to the PC.*

- **Baud Rate:** This sets the communication rate between the Communicator and controllers. For communication to operate properly, set all controllers to the same Baud Rate.
 - Since faster rates and longer transmission distance mean a greater chance of transmission errors, reduce the baud rate as you increase the distance.
 - In any case where there are transmission errors, reduce the baud rate.
 - Communicator, RLINK (if used), and controllers must have the same baud rate!

CAUTION *Incorrect definitions can result in alarms for missing controllers and communication from unidentified controllers.*

- **Channel:** This parameter sets the communication channel between the Communicator and an RLINK. For more information, refer to the RLINK or RLINK One Manual.
- **Address:** The address is a second layer used to set up a secure communication layer to an RLINK, in combination with the Channel or alone. For more information, refer to the RLINK or RLINK One Manual

Table 3: Address Configuration

	Square 1	Square 2
Address 0	unmarked	unmarked
Address 1	marked	unmarked
Address 2	unmarked	marked
Address 3	marked	marked

7.1.2 DISPLAYING THE CONTROLLERS

- Press 

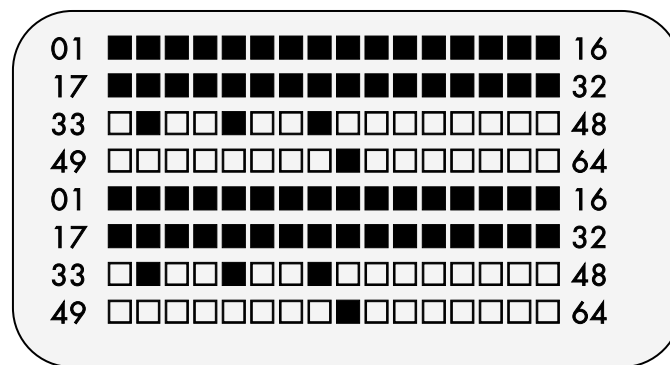

This screen displays all the controllers that are connected to the system.

- - Represents a recognized controller
- - No controller is recognized

NOTE: The letter 'F' indicates that communication to that house has been lost. The 'F' continues to appear until the unit is reset (disconnect and reconnect the power).

7.1.3 LISTING THE NETWORK DEVICES

- Select *SYSTEM > Test > Network List*.



- **Primary Found:** Displays the number of primary units found in the network.
- **Secondary Found:** Displays the number of secondary units found in the network.
- **Scan Network?:** Use +/- key to select YES or NO and then press **ENTER** to scan the network to find/remove primary or secondary units.

7.2 Channel/Signal tests

The following sections detail how to test the controller communication channels.

- Testing the RS-232/485 channel
- Testing the Radio RF signal

7.2.1 TESTING THE RS-232/485 CHANNEL

- Select *SYSTEM > Test > Wired 232/485*.

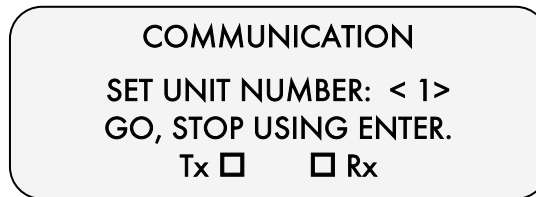

This menu tests the RS-232/485 communication channel.

Enter the required unit number and press **ENTER** to start and stop the test. The screen displays a shaded box in the Tx when transmitting and a shaded box by the Rx when receiving (when functioning properly the shading switches back and forth between the two boxes).

NOTE: *If the checkbox remains blank, check all connections between the Communicator and the controller.*

7.2.2 TESTING THE RADIO RF SIGNAL

- Select *SYSTEM > Test > Radio RF Signal*.

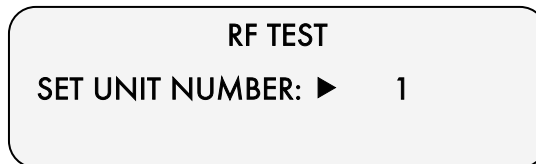

This menu tests the RF communication channel.

Enter the required unit number and press **ENTER**. The screen displays the reception bar graph as well as the measured signal reading once available (testing is continuous until exiting this menu).

8 Communicator to PC configuration

The following sections detail the communication between the Communicator and the PC.

- Defining the communication speed with the local PC
- Configuring the data connection

8.1 Defining the communication speed with the local PC

- Select *SYSTEM > Advanced Setup > COM/USB*.

COM/USB	
BAUD RATE	9600

This screen defines the communication speed (**Baud Rate**) corresponding with the local PC.

8.2 Configuring the data connection

- Select *SYSTEM > Advanced Setup > Line Modem > Advanced*.

DATA CONNECTION	
MODULATION	AUTO
COMPRESSION	ENABLE
DATA FLOW	2

The Communicator can compress data and send it faster. Use this screen to increase the transfer rate between the Communicator and a remote modem.

- **Modulation:** Auto or V34 transmission. During connect negotiation at which the modems have determined which modulation and rate will be used, meaning before any error.
- **Compression:** Enables or disables data compression performed by the modem, also known as hardware compression. It reduces the amount of time required to transfer data. Make sure the modem you are connected to can read and decompress the received data.
- **Data Flow:** This feature enables the hardware to vary the data transmission rate.

CAUTION Munters recommends that the user leave the Advanced menu items at their default settings.

9 Configuring the dry contact card

The following section details how to set up the dry contact cards. Communicator supports an eight dry contact digital input card that can be programmed as a normally open / close dry contact input. These inputs can be connected to a wide variety of sensors such as generator operation, magnetic door or window, thermostat, etc.

1. Select *SYSTEM > Digital Input*.

DIGITAL INPUT		
#	MESSAGE	[N]
1 ▶	door opened	1
2 ▶		0

2. Use the alphanumeric keypad to enter in the message and press **ENTER**.
3. Define **[N]** as 1 or 0

The '[N]' column's two possibilities:

- 0: Represents the open contact (Normally Open). If there is a change from the usual state (closed state), an alarm occurs.
- 1: Represents closed contact (Normally Closed). If there is a change from the usual state (opened state), an alarm occurs.

The figure above serves as an example of a digital input program. The programmed line No. 1 is set as normally closed for the house door. The message for this program is "door opened". If the door opens, the dry contact is disconnected and changes from 1 to 0. This change triggers the alarm and the message "door opened" is sent to all addresses programmed in the Adding names to the Address Book (page 22).

10 Communicator functions

The following sections detail functions which relate to the Communicator hardware and software.

- Saving and restoring system settings, page 39
- Viewing relay settings, page 40
- Test functions, page 39

10.1 Saving and restoring system settings

- Select *SYSTEM > Save/Res Setting > Restore*.

1. Restore: Use this feature to restore all settings that were previously saved (*restore point is the date of the last save performed*).



- Select *SYSTEM > Save/Res Setting > Save*.

2. Save: Use this feature to save all settings (*once a SAVE is performed, this is the new RESTORE point*).



10.2 Test functions

The following section details how to test Communicator functions.

- Testing the backup battery
- Viewing device status
- Viewing the software and hardware version

10.2.1 TESTING THE BACKUP BATTERY

This section details the CPU battery test.

- Select *SYSTEM > Test > Battery*.

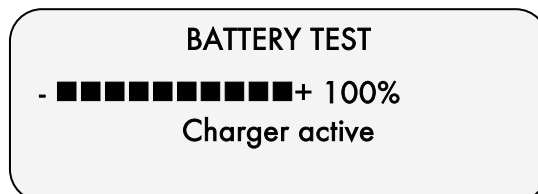

To test the battery:

1. Unplug the unit.
2. View the battery test.

CAUTION In addition to this test, refer to *Testing the alarm backup batteries*, page 45.

10.2.2 VIEWING DEVICE STATUS

- Select *SYSTEM > Test > Hardware Profile*.

HARDWARE PROFILE	
1 VOICE	OK
2 LINE MODEM	OK
3 CELLULAR	OK

View functionality status of all possible installed devices.

10.2.3 VIEWING THE SOFTWARE AND HARDWARE VERSION

- Press 

http://www.rottem.com	
SOFTWARE	3.00r01-b
HARDWARE	2.04
U1	1.00

This screen displays the software and hardware version numbers.

10.3 Viewing relay settings

RELAYS SETTING	
CODE	TIME (s)
RLY1	0
RLY2	0

- Select *SYSTEM > Relay*.

TBD

11 Alarms

This section details how to:

- Configure advanced alarm settings
- View the history of alarms and events

Basic Alarm functions are defined in the Initial configuration, page 20.

- Introduction to alarms and responses, page 41
- Event codes, page 42
- Advanced alarm settings, page 42
- Alarm and events history, page 44

11.1 Introduction to alarms and responses

Figure 8 illustrates the alarm sequence. The flow ends when an alarm is acknowledged or is no longer active.

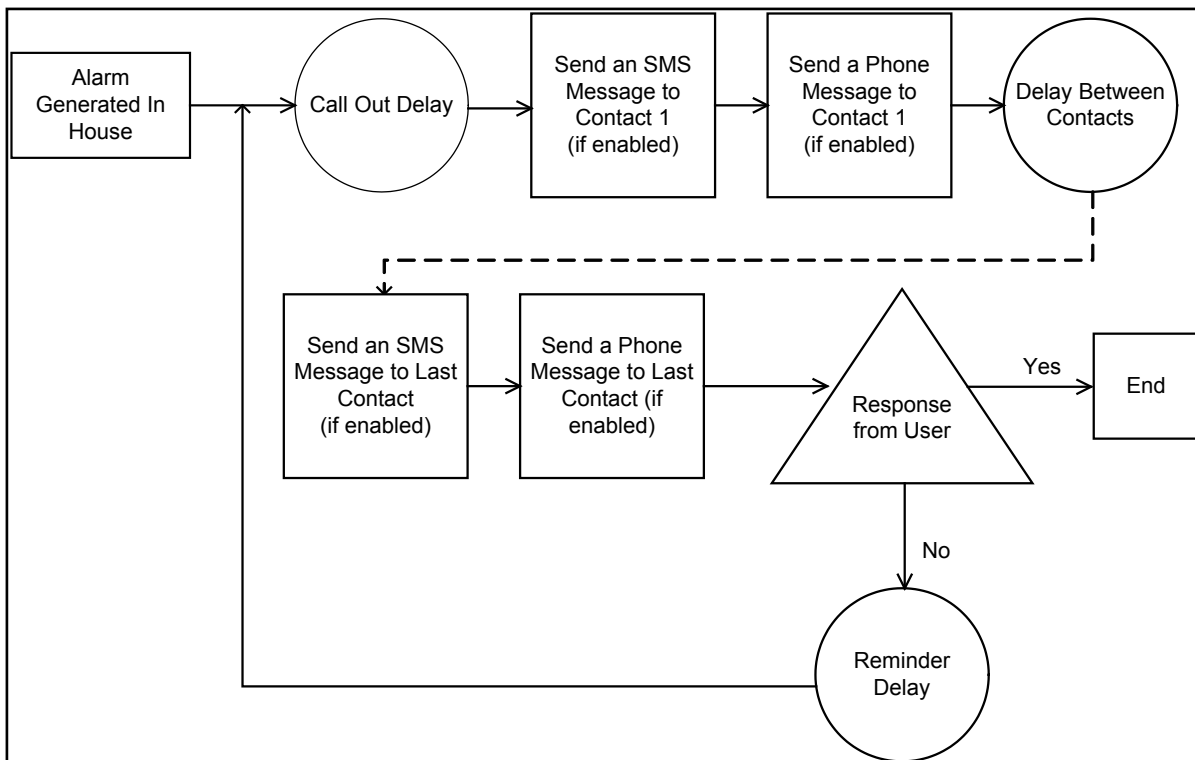

Figure 8: Alarm Flow Chart

Responding to alarms can be done over:

- **Land line:** Via verbal and interactive messaging
- **Cellular:** Via text messaging

NOTE: Communicator does not support verbal and interactive messaging via cell phones.

11.2 Event codes

Table 4 lists the event codes sent in text messages.

Table 4: Event Codes

Event Code	LCD Message
1	"power off "
2	"power on"
3	"cold start"
4	"error-01"
5	"test running"
6, 7 , 9, 10, 11, 12, 16, 17	"fail"
8, 13	"no answer "
14	"page sent "
18	"text sent "
19, 20	"ack alarm "
21	"disable alarm "
22, 23, 24	"low signal"

11.3 Advanced alarm settings

The following sections detail the advanced alarm functions. Basic alarms are set up in the Initial configuration (page 20).

- Resetting the alarms, page 42
- Disabling alarms, page 43
- Defining the message delay, page 43
- Defining the message repeat parameter, page 43
- Defining the internal alarms, page 44
- Defining the battery alarm, page 44

11.3.1 RESETTING THE ALARMS

- Select ALARM > Reset.

**SELECT UNIT (+/- KEY)
TO RESET PRESS ENTER
UNIT = ↵**

This menu resets the alarms of any controller that exists within the network. The Communicator's unit number is 0.

Use the +/- key to navigate to the required unit number.

11.3.2 DISABLING ALARMS

- Select ALARM > Disabled Alarms

DISABLE ALARMS		DISABLE ALARMS
HOUSE DISABLE	CODE	MESSAGE
23	YES	185→
25	YES	155→

View disabled alarms and re-enable these alarms.

NOTE: : Alarms are disabled until 12:00 PM the following day.

- Scroll right to view message.
- Press +/- to re-enable the alarm and then press ENTER.

NOTE: Alarms that are re-enabled are cleared from the list.

11.3.3 DEFINING THE MESSAGE DELAY

- Select ALARM > Options.

OPTIONS	
==MESSAGE DELAY==	
Call Out (s)	60
Between Users (s)	60
TEXT	
==MESSAGE REPEAT==	
Voice	20
Pager	35
Text	35
===INTERNAL ALARM===	
Delay(s)	60
Reminder (m)	60
Power Resto.Msg	NO

This menu defines the waiting times between an alarm event and its reporting.

- **Call-Out (seconds):** Define the waiting time before Communicator begins the reporting sequence.
- **Between Users (seconds):** Define the waiting time before contacting the next user within the address book.

11.3.4 DEFINING THE MESSAGE REPEAT PARAMETER

- Select ALARM > Options.

By default, when an alarm is sent, it must be acknowledged by one of the contacts. If there is no acknowledgment, Communicator resends the alarm (refer to Acknowledging a message, page 32).

This menu defines the waiting time before Communicator reinitiates the reporting (VOICE, PAGER, TEXT).

NOTE: Enter 0 to disable this option.

11.3.5 DEFINING THE INTERNAL ALARMS

- Select *ALARM > Options*.

Internal alarms are generated by the Communicator unit (external alarms are generated by the controllers). This menu defines:

- **Delay (seconds)**: Define the waiting time before Communicator generates an internal message.
- **Reminder (minutes)**: After an alarm has been acknowledged but not dealt with, the Communicator recreates an internal message according to the amount of time defined. Define the time in this option.
- **Power Restore Message**: Define YES/NO for a message to be sent after a Power Restore event

11.3.6 DEFINING THE BATTERY ALARM

- Select *SYSTEM > Advanced Setup > Battery*.

This menu defines the hold time (in seconds) before the Communicator generates an alarm message regarding the battery charge.

POWER OPTION	
ALARM DELAY(S)	60

11.4 Alarm and events history

This section details how to view records of alarms and events.

- Displaying the alarm history, page 44
- Displaying the user events, page 45
- Displaying the system events, page 45

11.4.1 DISPLAYING THE ALARM HISTORY

- Select *HISTORY > Alarms*.

LOG [SORT BY: H]			
HOUSE	DATE	CODE	
1	07-FEB	240	→
2	05-FEB	240	→XT
3	06-FEB	240	→
3	07-FEB	240	→
4	07-FEB	240	→
5	06-FEB	240	→

This screen displays alarms from all houses as well as the Communicator (Communicator: 0 and Houses: 1 - 64).

- Use +/- to toggle the SORT BY option from: H=House; D=Date; and C=Code.
- Scroll right to view message.

11.4.2 DISPLAYING THE USER EVENTS

- Select ALARM > User Events.

USER EVENTS		
DATE	TIME	CODE
18-JAN	16:16	2 →
07-FEB	11:47	2 →

Any changes or events created by users from the address book appear in this table.

- Scroll right to view alarm and user number.
- Code is the alarm code.

11.4.3 DISPLAYING THE SYSTEM EVENTS

- Select ALARM > System Events.

SYSTEM EVENTS		
DATE	TIME	CODE
18-JAN	16:16	2 →
07-FEB	11:47	2 →

This menu displays all Communicator system events.

- Scroll right to view message.

11.5 Testing the alarm backup batteries

To ensure that the Communicator continues to broadcast alarms in the event of a power outage, the unit comes equipped with a set of 12 V backup batteries. These batteries must be kept properly charged at all times.

WARNING! *Failure to test your pack regularly and change the pack as required can result in losses in the event of a general power failure!*

Munters strongly recommends:

- Checking the backup battery pack once a month (see the procedure below).
- Replacing the battery pack once a year, regardless of the test results.

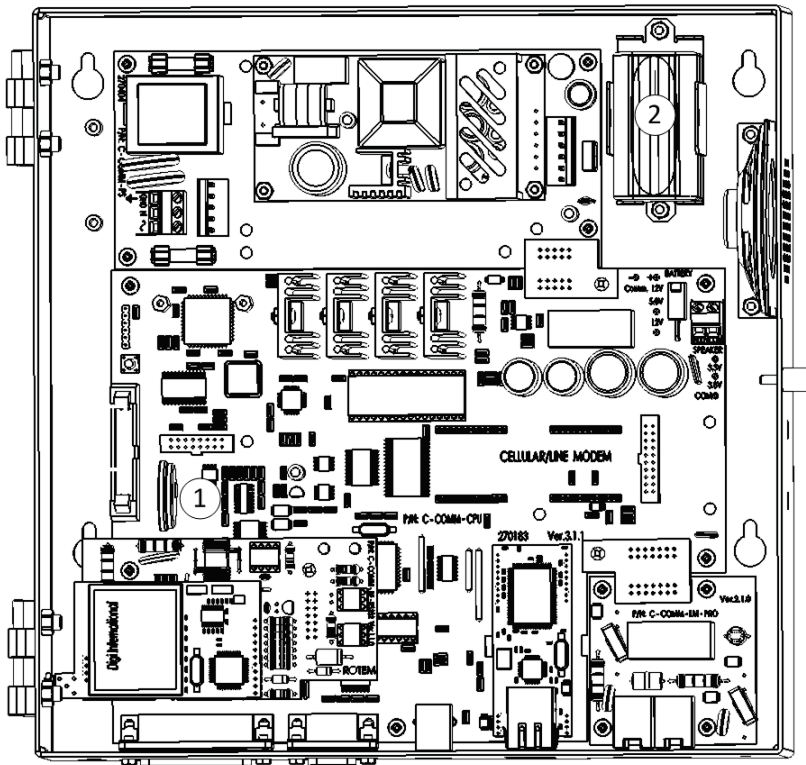

Figure 9: Communicator Battery Packs

The following two tests provide accurate data regarding the backup battery pack's charge level. Munters recommends performing both tests.

If you need to replace the battery, order a Communicator Battery Pack (P/N: SP-COMM-BA).

NOTE: Munters recommends keeping a spare pack in stock to avoid any shipping delays.

11.5.1 DIAL-UP TEST

- Unplug the unit.
 - If the batteries are charged, Communicator sends an SMS/voice/pager alarm message to the numbers configured in the Address Book. The message should arrive within several minutes.
 - If the batteries are not charged, Communicator does not send an alarm message. In addition, an alarm message appears on the screen.

11.5.2 VOLTAGE TEST

1. Remove the battery pack.
2. Using a voltmeter, test the pack. The voltage of a new, charged battery pack ranges between 7.2 V and 7.6 V. The voltage of a battery pack that has been in use for an extended period of time will be 7.2 V or lower.
 - If the power is above 7.0 volts or higher, continue using the battery pack.
 - If the power is below 7.0 volts, replace the pack immediately.

CAUTION Check the CPU Battery once a year, as described in Testing the backup battery, page 39.

12 Troubleshooting

The following section details common troubleshooting procedures.

- Hardware, page 47
- Cellular modem, page 49
- Voice card, page 51
- Line modem, page 52
- Communication to controllers/PC, page 47
- RF communication, page 50
- Alarm, page 52

12.1 Hardware

Connected hardware is not recognized in the hardware profile list under system Menu (voice, cell modem, Line modem)

Refer to Viewing device status, page 40.

The Communicator displays O.K. for an installed device and N/A for a device that is not available.

1. Reset the hardware: Turn the battery switch OFF and unplug the power source.
2. Reconnect the power and switch the battery ON so that the unit rescans the hardware.
3. Open the Communicator and check that the device is installed properly.
4. If still not operating, replace the device.

Battery failure alarm is received

1. Make sure the Communicator is connected to an electric power supply.
2. In 'Battery Test' menu (page 39), check the battery and charger status.
3. Open the Communicator's box and check the battery's wiring (Figure 1, page 11).
4. If the wiring connections are OK, replace the battery pack. (Part number: SP-COMM-BAT).

NOTE: *If you replace the voice card, Ethernet card, line modem or cell modem, perform a [Cold Start](#) after replacing the device.*

12.2 Communication to controllers/PC

NOTE: *Refer to Displaying the controllers, page 35 to display the controller.*

Not all units found due to updating primary units. In other words, the number of controllers is not identical to the number of controllers entered in the Controllers menu (Identifying the controllers, page 22).

1. Make sure the Communicator is connected to an electric power supply.
2. Press **Hot Key 0** (page 35) and check if either some of the controllers are missing (empty squares), or all of them.
3. Check communication with the missing unit:
 - If the system has a wired connection, refer to Channel/Signal tests, page 35.
 - If the system has an RF link, refer to page 35.

4. Check Baud Rate (refer to the relevant section in Network connection, page 34) on both sides if using 232/485 communication card.
5. Go over the number of controllers and make sure there is no conflict between the units (make sure that two units do not have the same configuration number).
6. If all above are OK:
 - Check the wiring for 232/485 communication card.
 - Check RF card signal strength (refer to Testing the cellular signal strength, page 25).

'Lost unit number' alarm

1. Verify that the Communicator is connected to a power supply.
2. Press **Hot Key 0** (page 35) and check if either some or all of the controllers are missing (empty squares).
3. Verify communication with the missing unit:
 - If the system has a wired connection, go to *System - Test - Wired RS232/485* (refer to page 36).
 - If the system has an RF link, go to *Radio System - Test Radio RF Signal* (Refer to page 36).
4. If you are using a 232/485 communication card, check the Baud Rate on both sides (refer to Configuring the channel settings, page 34).
5. If an RF communication card is being used, check [Additional Channel Setting](#).
6. Go over the controller numbers and make sure there is no conflict between the units (make sure two units do not have the same configuration number).
7. If all above are Ok:
 - Make sure the wiring is OK for communication card 232/485.
 - Check signal strength for RF card (refer to Testing the cellular signal strength, page 25).

No local communication with PC

1. Ensure that the serial port Baud Rate matches the PC baud rate (page 34).
2. Go to Computer Port list. 'Com 1 RD' LED should flash on the front panel. Test the Communicator through RotemNet software.

NOTE: *If the LED does not flash, it is not the right computer port.*

3. If using a USB cable, reinstall the driver from the CD (refer to USB Driver Installation, page 14).

1. If signal does not improve, insert the SIM card into a cell phone and check the signal (GSM only).
2. If the signal is weak, check with your service provider.
3. If the signal is OK, change the module.
4. If no signal exists:
 - Check antenna connection.
 - Check connection to the module (GSM).
 - Check the wiring. If there is a problem, contact the dealer.

Refer to the appropriate section in Appendix A: Replacing communication cards and modems, page 54 for detailed instructions on exchanging the modem.

- Text test failure in menu (refer to Testing the text function, page 29).

The modem has to be placed in a way that ensures sufficient signal strength. To improve signal strength, the antenna can be moved to another position. Signal strength may depend on how close the modem is to a radio base station. You must ensure that the location, at which you intend to use the modem, is within the network coverage area

12.4 RF communication

No RF connection

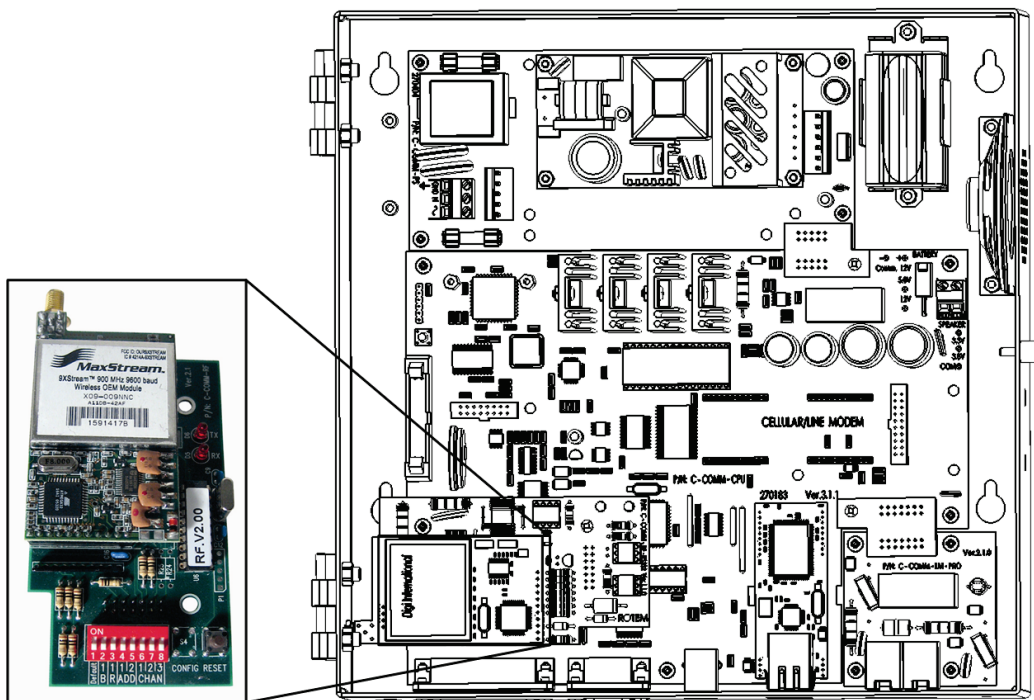

Figure 12: RF Card Location

- Check the signal strength (refer to Testing the Radio RF signal, page 36).
 - If it is weak, change the antenna location.
 - If the strength is zero:
 1. Check the baud rate and the channel address (refer to Configuring the channel settings, page 34). Correct if needed.
 2. Ensure that the Communicator's baud rate matches the controllers' baud rate.
- Check RF card configuration:

- Try to change the baud rate and channels on both sides (refer to Configuring the channel settings, page 34).

NOTE: *In this situation, lower the baud rate.*

- Improve the antenna's location.
- Replace P-COMM-RF10-9-S COMMUNICATOR RF (Refer to Replacing the RF-card, page 55).

12.5 Voice card

Voice does not function

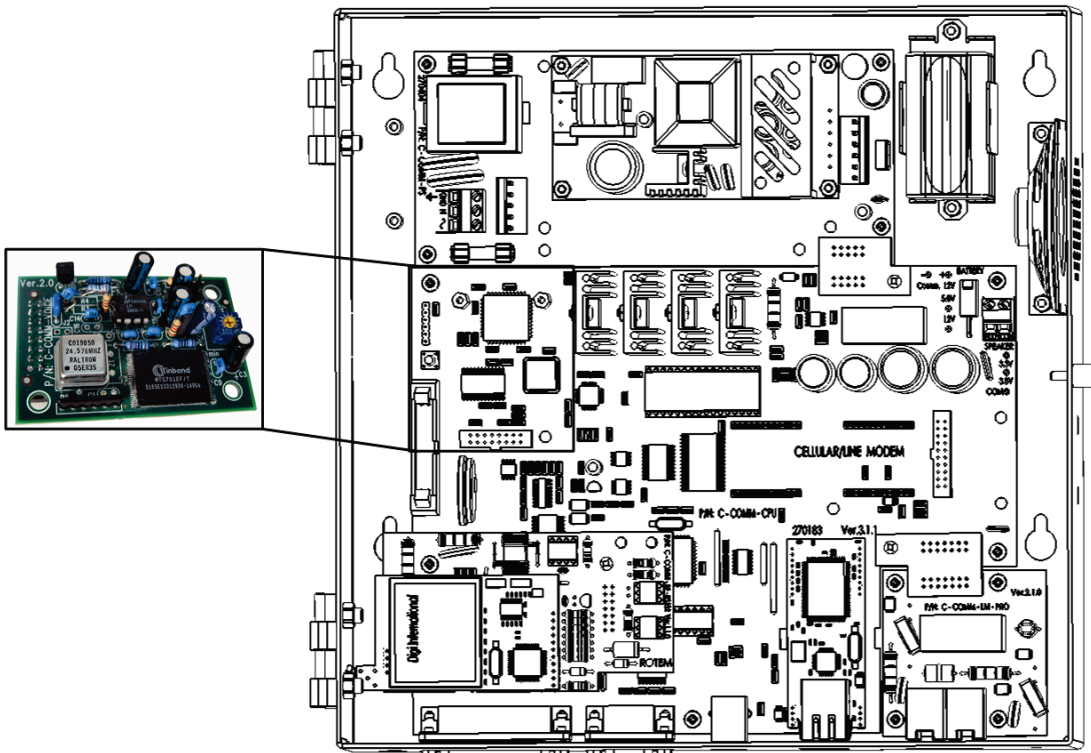

Figure 13: Voice Card Location

1. Refer to Testing voice, page 25 and perform voice test.
2. Change the parameters as required (refer to Setting the voice , page 24).

NOTE: *Do not forget to confirm by moving the cursor to the 'TEST' parameter and pressing 'ENTER'.*

3. Verify speaker cable is connected.
4. Turn volume trimmer on voice card until required volume is reached (Figure 14) (Refer to Figure 1, page 11 to see the voice card location).
5. If none of the above helps, contact your dealer.

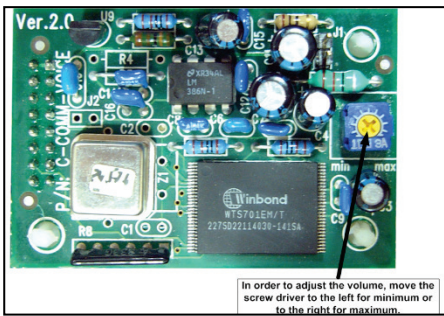

Figure 14: Volume Trimmer

12.6 Alarm

No messages are being received from the Communicator

1. Verify active alarms are not defined as disable state (refer to Setting the test schedule, page 20).
2. Go over the contact group, make sure the users are not set to 'idle' (refer to Adding names to the Address Book, page 22) and that the contact information is entered correctly.
3. Verify that the controllers are functioning properly (meaning are transmitting alarms or messages).

Alarm LED is ON but the siren does not operate

1. Check the siren's connection to the relay with battery (see Figure 3, page 13).
2. Perform an alarm relay test found in *SYSTEM->Technician Tools->Test->Relays* (refer to Test, page 33).

12.7 Line modem

'No dial tone' alarm

1. Verify that there is a line by using a phone connected to the phone jack.
2. Perform **PHONE LINE VOLTAGE** test, (*SYSTEM - Technician Tools - Test - Phone Line* (page 33)). Voltage should be above 40 V (normally it is 48 V or more).
3. If it is above 40 V, connect a regular phone for testing.
4. If the line is not operating, check with your service provider.
5. If the line is operational, perform power cycle for Communicator (turn device off and then back on). Allow a few minutes until the Communicator recovers.

Dial Out is not functioning



1. Insert extra delay by adding commas (refer to Configuring the dial delay, page 29).
2. If you have an ADSL modem on the same line, verify that your ADSL line filter meets your service provider's specifications (high quality line balanced).
3. Contact technical support.

12.8 Battery

'critical error/check battery wiring' alarm appears

1. Check the backup battery wiring; verify that all connections are in place.
2. If the pack is correctly wired, the battery pack does not hold a charge. Replace the pack.

13 Technical data

Power Supply	
Mains Voltage	Single Phase 230 VAC (outside the US & Canada)
115 VAC	0.5 A (US & Canada)
Mains Frequency	50/60 Hz
Maximum Power Consumption	40 W
Main Fuses	
Main Fuse (12 V)	125/250 V, 100 mA T
Main Fuse (Switching P.S.)	125/250 V, 2 A T
Connection Box Peripherals	
Digital Inputs	
8 Digital Inputs	Dry Contact, 5V /2 mAmp
Relays Outputs	
N.C/N.O. (OMI) Blue Small Low Power Relay	5 Amps, 250 VAC
Alarm Output	
N.O and N.C (Double) (OMI) Pilot Duty	5 Amps, 250 VAC
Housing	
Metal Box Dimensions (L x W x H)	262 x 262 x 80 mm
Ambient Climate	
Operating Temperature Range	0° to +50° C / 32° to 125° F
Operating Humidity Range	0% to 95%
Storage Temperature Range	-10° to +70° C / 14° to 158° F
Certification	
	 

14 Appendix A: Replacing communication cards and modems

The following sections illustrate how to replace various communication cards.

NOTE: Refer to *Choosing communication cards*, page 8 for further information on Munters communication cards.

- Replacing the RS-232 card, page 54
- Replacing the RF-card, page 55
- Installing a GSM-S or GSM-W card , page 56
- Installing a 3G Cell Modem Card, page 56

14.1 Replacing the RS-232 card

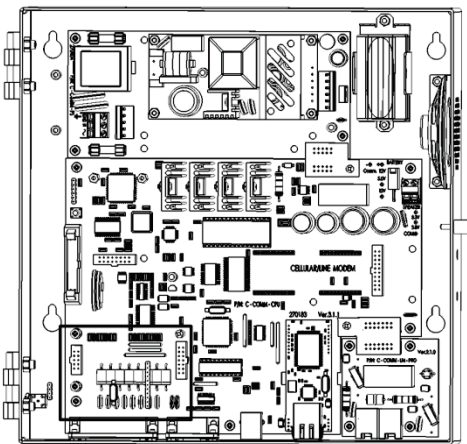

- Insert the RS-232/485 communication card into the indicated sockets and fasten it with two screws.

14.2 Replacing the RF-card

1. Insert the card in its socket.

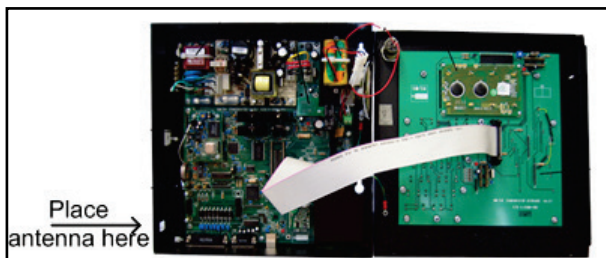
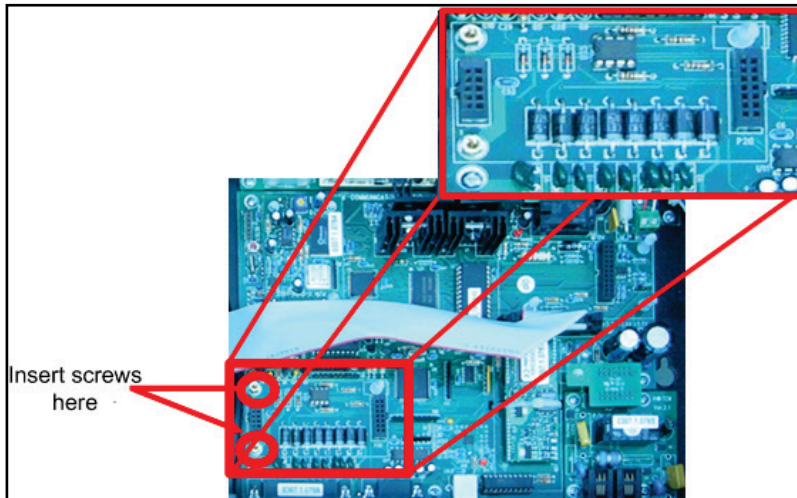

2. Fit the black wire through the hole as illustrated above and connect to the RF card. Screw nuts connected to the RF card (make sure you leave enough slack for antenna cable).
3. Set the dipswitches. Refer to the *RF Communication Card Installation* sheet for more information.

14.3 Installing a GSM-S or GSM-W card

NOTE: Before installing a SIM card, disable the PIN code (if the card has this code). Communicator text functions are disabled if the SIM card has a PIN code.

1. Turn off the Communicator and open the cover.
2. Place the card in place.

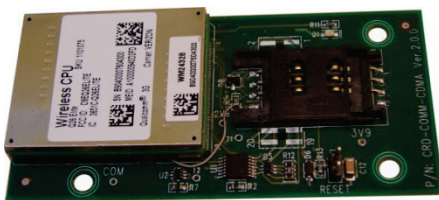
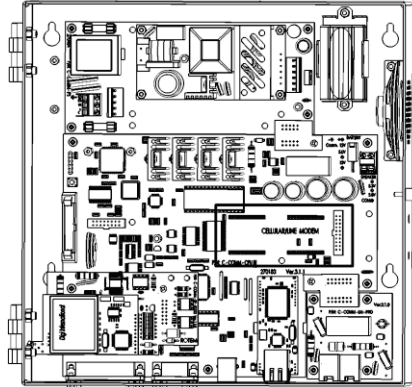

Insert a SIM card into GSM-S or GSM-W to enable the Voice Dial-In feature.

NOTE: Refer to *Configuring the telephone modem*, page 26 for information regarding the Voice Dial-In feature.

WARNING! Communicator does not support pre-paid SIM cards. Use a regular card only!

14.4 Installing a 3G Cell Modem Card

NOTE: Before installing a 3G card, disable the PIN code (if the card has this code). Communicator text functions are disabled if the card has a PIN code.

1. Turn off the Communicator, disconnect the power and open the cover.
2. Place the card in place.

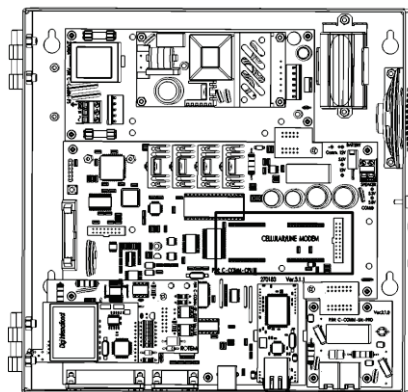

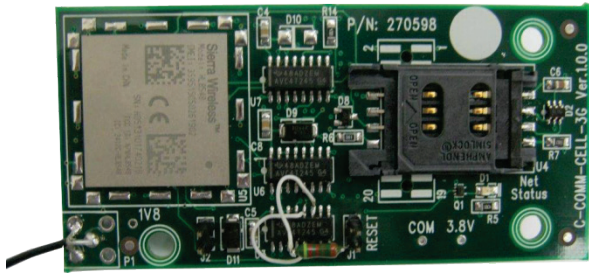

Insert a SIM card to enable the Voice Dial-In feature.

1. Insert the cell modem cable into the Cell Modem mounting port and tighten the retaining bolt.
2. Close the cover, apply power and turn on the unit.
3. Go to *System > Save/Res Setting > Save* and backup all settings
4. Perform a Cold Start. Communicator will detect the new modem.
5. If required, restore the Communication Unit's settings.
6. Go to *SYSTEM → Test → GSM/CDMA*. The signal strength must be between -113 dBm to -51 dBm.
7. Go to *SYSTEM → TEST → GSM/CDMA → SEND TEXT MSG.*
 - a. Enter in the required mobile phone number to receive the "Test Text" and press ENTER.
 - b. Confirm that the mobile phone received the following text message:
 - "Your Communicator is ready to send alerts via text message"

1.5 Appendix B: Communicator / Controller connectivity

When designing a control system:

- Communicator supports multiple infrastructure technologies: RS-232, RS-485, and RS-485 Isolated.
- Each controller has its own specific communication card for any supported communication infrastructure.
- There is specific wiring required for each infrastructure.

This paper details which 1) controller communication cards to install 2) wiring infrastructure to use in order to support each infrastructure technology.

Infrastructure	RS-232 Current Loop	RS-485 Standard	RS-485 Isolated
Communicator Communication Card	C-COMM-RS232	C-COMM-RS485	C-COMM-485
Controllers' Communication Cards			
Platinum	232 ISO / 232 Extension Card (P/N: C-PP-RCLP232)		485 ISO/ 232 Extension Card (P/N: C-PP-485ISO-232)
	232 ISO / 485 Extension Card (P/N: C-PP-232ISO-485)	485 STD/ 485 Extension Card (P/N: C-PP-RCLP485)	485 ISO/ 485 Extension Card (P/N: C-PP-485ISO-485)
Super Guard	NA	SGP 485 Communication Card (P/N: C-SG-RCLP)	NA
SMART A	Smart 232 Communication Card (P/N: C-SMART-RS232)	Smart 485 Communication Card (P/N: C-SMART-RS485)	Smart 485 Communication ISO (P/N: C-SMART-RS485-ISO)
AC-2000 3G/SMART C	AC-3G 232 Comm. Card (P/N: C-RNET-RS232)	N/A	RLINK 485 Comm. ISO (P/N: C-RNET-485)
AC-2000, RFS, RSW	Direct On-Board	Use an External RS-485 Converter	Use an External RS-485 Converter

16 Appendix C: Ethernet Card/RotemNet Setup

This section explains how to set up an internet connection for Communicator unit having an Ethernet Card (P/N: 904-99-00054). Users having a Comm-Box should refer to Communicator / Comm-Box Connectivity, page 18.

- Setting Up an Internet connection
- Setting Up a Network using RotemNet

16.1 Setting Up an Internet connection

Accessing the Communicator and controllers via a web browser enables viewing the controller parameters.

NOTE: For full control use RotemNet (refer to Setting Up a Network using RotemNet, page 60).

Internet is supported by:

- Communicator, software version 3.0 and higher
 - Platinum Controllers, software version 3.0 and higher
 - Munters Net, version 1.3.17 and higher
1. In the Communicator screen, select *SYSTEM > Advanced Setup > Internet > My Account*.
 2. Write down the Ethernet device serial number.
 3. On the Ethernet cable port (Figure 1), verify that:
 - the green lights remains on
 - the yellow light blinks
 4. Set the Communicator Internet settings.
 - a. In a web browser, go to <http://82.80.235.51/>.
 - b. In the Account Name field, type **Rotem**.
 - c. In the Password field, type **1**.

The **Register** page appears.

- d. Fill out all of the fields.

NOTE: The Allowed S/N is the Device S/N found in *SYSTEM > Advanced Setup > Internet*.

NOTE: If you want to add a picture to your Internet account, click **Browse** and select the file.

- e. Type the CAPTCHA letters.
- f. Click **Submit**.

Myrotemnet sends a confirmation message to the account email address.

5. In *SYSTEM > Advanced Setup > Internet > My Account*
 - a. Edit the **IP** number or address (myrotem.net) and **PORT** number as required.
 - b. In the **Name** field, type the name.

- c. In the **Account** name, type the account name that you chose on the myrotemnet page.
- d. In the **Users** field, type the maximum number of users that can simultaneously access the network.
- e. Click **Save**.

INTERNET

DEVICE SN: 140011BD

[SERVER]

IP: 80.179.187.139

Port: 1500

Name: Rotem

Account: <Farm 1

Users: 03

The Internet connection is now configured.

- 6. In a web browser, go to <http://www.myrotem.net> and login using the name and password that you chose.
 - If the Communicator is defined correctly, it is displayed on the site with its name and its status is a green circle.
 - If the Communicator is not defined correctly, it does not appear on the screen.
 - The red exclamation mark (!) indicates that the chip is not online. This means that there is a connectivity problem, lost internet connection, or other possible problems. It does not mean that the Communicator is not defined properly.

7. Click  to view the controller details.

Munters recommends the following resolutions when viewing the web:

- PC: 1280/1024 Text size medium
- Laptop: 1024/768 Text size medium

16.2 Setting Up a Network using RotemNet

Accessing the Communicator or controllers via RotemNet enables local and remote management of your equipment. The following is a summary of the steps needed to setup a remote network using the RotemNet software. For complete instructions, refer to the *RotemNet* manual.

1. Using the provided CD, install and run RotemNet.
2. Refer to the following sections:
 - Local network
 - Remote network

16.2.1 LOCAL NETWORK

1. Under Network Setup, select *Local Network*.
2. Select the required baud rate.

NOTE: *The selected baud rate must be the same as the rate selected in the Communicator.*

3. Select the communication port.

NOTE: *If the connection is via the USB port, select Communicator.*

4. Select the number of controllers and the controller type.

5. Press **Start Scan**.

RotemNet scans the system and lists the controllers.

16.2.2 REMOTE NETWORK

1. In *RotemNet*, select *Internet* and click **OK**.

2. In the Internet Communication window set the:

- Farms account name
- Account Name
- Chip serial number
- Password

NOTE: *This information must be the same as the data entered in Communicator.*

3. If you are configuring multiple farms:

- Enter a name for each farm.
- Enter an Ethernet chip number for each farm.
- Configure the controller setup for each farm.

4. To connect to a farm, click **Connect**.

NOTE: *Refer to Initial configuration, page 20 for instructions on the initial configuration.*

17 Warranty

Warranty and technical assistance

Munters products are designed and built to provide reliable and satisfactory performance but cannot be guaranteed free of faults; although they are reliable products they can develop unforeseeable defects and the user must take this into account and arrange adequate emergency or alarm systems if failure to operate could cause damage to the articles for which the Munters plant was required: if this is not done, the user is fully responsible for the damage which they could suffer.

Munters extends this limited warranty to the first purchaser and guarantees its products to be free from defects originating in manufacture or materials for one year from the date of delivery, provided that suitable transport, storage, installation and maintenance terms are complied with. The warranty does not apply if the products have been repaired without express authorisation from Munters, or repaired in such a way that, in Munters' judgement, their performance and reliability have been impaired, or incorrectly installed, or subjected to improper use. The user accepts total responsibility for incorrect use of the products.

The warranty on products from outside suppliers fitted to Communicator (for example sensors, cables, thermostats, etc.) is limited to the conditions stated by the supplier: all claims must be made in writing within eight days of the discovery of the defect and within 12 months of the delivery of the defective product. Munters has thirty days from the date of receipt in which to take action, and has the right to examine the product at the customer's premises or at its own plant (carriage cost to be borne by the customer).

Munters at its sole discretion has the option of replacing or repairing, free of charge, products which it considers defective, and will arrange for their despatch back to the customer carriage paid. In the case of faulty parts of small commercial value which are widely available (such as bolts, etc.) for urgent despatch, where the cost of carriage would exceed the value of the parts, Munters may authorise the customer exclusively to purchase the replacement parts locally; Munters will reimburse the value of the product at its cost price.

Munters will not be liable for costs incurred in demounting the defective part, or the time required to travel to site and the associated travel costs. No agent, employee or dealer is authorised to give any further guarantees or to accept any other liability on Munters' behalf in connection with other Munters products, except in writing with the signature of one of the Company's Managers.

WARNING: *In the interests of improving the quality of its products and services, Munters reserves the right at any time and without prior notice to alter the specifications in this manual.*

The liability of the manufacturer Munters ceases in the event of:

- dismantling the safety devices;
- use of unauthorised materials;

- inadequate maintenance;
- use of non-original spare parts and accessories.

Barring specific contractual terms, the following are directly at the user's expense:

- preparing installation sites;
- providing an electricity supply (including the protective equipotential bonding (PE) conductor, in accordance with CEI EN 60204-1, paragraph 8.2), for correctly connecting the equipment to the mains electricity supply;
- providing ancillary services appropriate to the requirements of the plant on the basis of the information supplied with regard to installation;
- tools and consumables required for fitting and installation;
- lubricants necessary for commissioning and maintenance.

It is mandatory to purchase and use only original spare parts or those recommended by the manufacturer.

Dismantling and assembly must be performed by qualified technicians and according to the manufacturer's instructions.

The use of non-original spare parts or incorrect assembly exonerates the manufacturer from all liability.

Requests for technical assistance and spare parts can be made directly to the nearest Munters office. A full list of contact details can be found on the back page of this manual.

Munters Israel

18 HaSivim Street

Petach-Tikva 49517, Israel

Telephone: +972-3-920-6200

Fax: +972-3-924-9834



www.munters.com

Australia Munters Pty Limited, Phone +61 2 8843 1594, **Brazil** Munters Brasil Industria e Comercio Ltda, Phone +55 41 3317 5050, **Canada** Munters Corporation Lansing, Phone +1 517 676 7070, **China** Munters Air Treatment Equipment (Beijing) Co. Ltd, Phone +86 10 80 481 121, **Denmark** Munters A/S, Phone +45 9862 3311, **India** Munters India, Phone +91 20 3052 2520, **Indonesia** Munters, Phone +62 818 739 235, **Israel** Munters Israel Phone +972-3-920-6200, **Italy** Munters Italy S.p.A., Chiusavecchia, Phone +39 0183 52 11, **Japan** Munters K.K., Phone +81 3 5970 0021, **Korea** Munters Korea Co. Ltd., Phone +82 2 761 8701, **Mexico** Munters Mexico, Phone +52 818 262 54 00, **Singapore** Munters Pte Ltd., Phone +65 744 6828, **South Africa and Sub-Sahara Countries** Munters (Pty) Ltd., Phone +27 11 997 2000, **Spain** Munters Spain S.A., Phone +34 91 640 09 02, **Sweden** Munters AB, Phone +46 8 626 63 00, **Thailand** Munters Co. Ltd., Phone +66 2 642 2670, **Turkey** Munters Form Endüstri Sistemleri A.Ş, Phone +90 322 231 1338, **USA** Munters Corporation Lansing, Phone +1 517 676 7070, **Vietnam** Munters Vietnam, Phone +84 8 3825 6838, **Export & Other countries** Munters Italy S.p.A., Chiusavecchia Phone +39 0183 52 11