

Manual for use and maintenance

Farm Center
/ Farm
Master Plus



Farm Center, Farm Master Plus

Controllers

Ag/MIS/UmGB-2132-08/13 Rev 2.3
P/N: 110125



Farm Center, Farm Master Plus

Manual for use and maintenance

Revision: N. 2.3 of 07/2017

Product Software: Version 1.10

This manual for use and maintenance is an integral part of the apparatus together with the attached technical documentation.

This document is destined for the user of the apparatus: it may not be reproduced in whole or in part, committed to computer memory as a file or delivered to third parties without the prior authorization of the assembler of the system.

Munters reserves the right to effect modifications to the apparatus in accordance with technical and legal developments.

Index

<i>Chapter</i>		<i>page</i>
1	INTRODUCTION	6
1.1	Disclaimer	6
1.2	Introduction	6
1.3	Notes	6
2	SAFETY ASPECTS	7
2.1	Grounding	7
2.2	Filtering	7
2.3	Checking the battery level	7
2.4	Frequency inverters	7
3	INTRODUCTION TO THE FARM CENTER/FARM MASTER PLUS	9
3.1	Components	9
3.2	General Description	9
3.3	Features	10
3.4	Farm Center/Farm Master Plus network connection	11
4	GETTING STARTED	12
4.1	Farm Center keyboard	13
4.2	Farm Center main screen	13
4.3	Hotkeys	15
4.4	Farm Center setup	17
4.5	Main Menu	19
5	CONTROL MENU	20
5.1	Temp Curve	20
5.2	Min. Max. Level	21
5.2.1	Soft Min Max by Day Levels	22
5.2.2	Setting Cold Warm Levels	23
5.2.3	By Weight	23
5.3	Humidity	24
5.4	Static Pressure	24
5.5	System Parameters	25
5.6	Control Mode	29

6	DEVICE MENU	30
6.1	Cycle Operation	30
6.2	Vent Levels	30
6.3	Variable Fan Levels	32
6.4	Curtain Levels	32
6.5	Circulation Fan	33
6.6	Cool Pad	33
6.7	Foggers	34
6.8	Light	35
6.9	Feed	35
6.10	Extra System	35
6.11	Time Clocks	35
7	MANAGEMENT MENU	36
7.1	Animal Inventory	36
7.2	Day & Group	36
7.3	Alarm Setting	37
7.4	Alarm Reset	38
7.5	Version	38
7.6	Read From Plug	38
7.7	Write To Plug	39
8	HISTORY MENU	40
8.1	Temperature	40
8.2	Humidity	40
8.3	Water	41
8.4	Feed	41
8.5	Mortality	41
8.6	Heater	42
8.7	Alarm	42
8.8	Event	43
9	CALIBRATION MENU	44
9.1	Temperature	44
9.2	Humidity	44
9.3	Pressure	44
9.4	Water & Feed	44
10	INSTALLATION MENU	45
10.1	Relay Layout	45
10.2	Sensors Layout	46

10.3	Digital Input	46
10.4	Analog Output	47
10.5	Variable Speed Fan	47
10.6	Sensor Definition	48
10.7	Curtain Setup	48
10.8	Fan Air Capacity	49
11	FARM MASTER PLUS	50
11.1	Cold Start	50
11.2	Set Unit Number	50
11.3	Main Menu	50
11.4	Calibration	51
11.4.1	Temperature sensor calibration	51
11.4.2	Calibration procedure	51
11.5	TRIAC Calibration	51
11.6	Test	53
12	SPECIFICATIONS	54
13	MECHANICAL INSTALLATION GUIDE	55
13.1	Environmental protection	55
13.2	Sensors and shielded wiring	55
13.3	Installation and electrical connections	56
13.4	Farm Center/Farm Master Plus wiring diagrams	57
13.5	Dip Switch Configuration	63
13.6	Extension Box	64
14	ELECTRICAL GROUNDING	66
14.1	Ground Rods	66
14.2	Ground Wire	66
14.3	Ground Clamps	67
14.4	What Should Be Grounded?	67
14.5	Lightening Protection	67
14.5.1	Power Line Protection	67
14.5.2	Communication Line Protection	67
15	WARRANTY	68

1 Introduction

1.1 Disclaimer

Munters reserves the right to make alterations to specifications, quantities, dimensions etc. for production or other reasons, subsequent to publication. The information contained herein has been prepared by qualified experts within Munters. While we believe the information is accurate and complete, we make no warranty or representation for any particular purposes. The information is offered in good faith and with the understanding that any use of the units or accessories in breach of the directions and warnings in this document is at the sole discretion and risk of the user.

1.2 Introduction

Congratulations on your excellent choice of purchasing a Farm Link!

In order to realize the full benefit from this product it is important that it is installed, commissioned and operated correctly. Before installation or using the fan, this manual should be studied carefully. It is also recommended that it is kept safely for future reference. The manual is intended as a reference for installation, commissioning and day-to-day operation of the Munters Controllers.

1.3 Notes

Date of release: July 2010

Munters cannot guarantee to inform users about the changes or to distribute new manuals to them.

NOTE All rights reserved. No part of this manual may be reproduced in any manner whatsoever without the expressed written permission of Munters. The contents of this manual are subject to change without notice.

2 Safety aspects

2.1 Grounding

- Always connect temperature and sensor shields to an earth ground. Avoid mixing high voltage wiring with sensor and low voltage wiring.
- Keep the controller as far as possible from heavy contactor boxes and other sources of electrical interference.
- Do not connect communication wire shields, which go from one house to another at both ends. Connect them at one end only. Connection at both ends can cause ground loop currents to flow, which reduce reliability.
- The COM connection for communications is not the shield wire. The COM, RX and TX wires must connect to each other in all controllers.

2.2 Filtering

If this installation includes a power inverter to drive variable speed fans, install an EMI filter in front of the inverter, according to the specifications provided by the inverter manufacturer. Refer to the inverter documentation.

2.3 Checking the battery level

Check the battery once a year. The output must be 2.7 volts (minimum). Authorized personnel only must replace the battery.

2.4 Frequency inverters

Frequency inverters can cause severe electrical and electromagnetic interference. Therefore, when employing a frequency inverter, it is critical that you carefully follow the manufacturer's installation instructions.

In particular verify:

- that the cable shielding between the inverter and any motor meets industry standards
- proper grounding of the inverter's chassis and motor power cable
- proper grounding of low voltage cable shield wire
- that the controller and inverter cables are kept in separate conduits or wire bundles

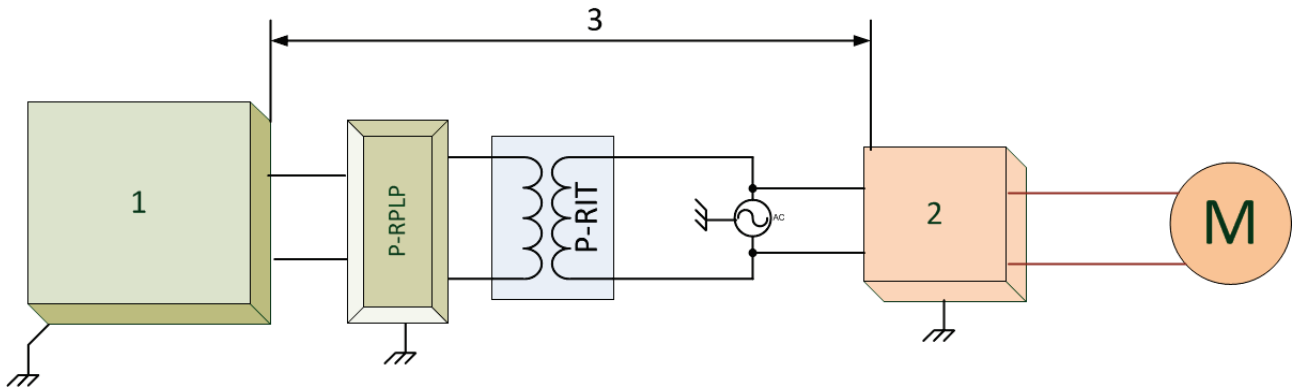

1. Controller
2. Inverter
3. Place the controller at least five meters from the inverter

3 Introduction to the Farm Center/Farm Master Plus

This manual provides easy-to-use information for installation, operation, long/short term planning and parts listing. Read this manual before operating your Munters Controller.

3.1 Components

- Farm Center
- Farm Master Plus
- Extension Box (optional)
- MUX 485 Communication / Farm Guard Communication (optional)

3.2 General Description

Both Farm Center and Farm Master Plus have individual software programs. These programs are designed to work together. However, both programs must have the same versions (for example if your Farm Center unit employs Version 1.10, Farm Master Plus must also use that version). Using different software versions can impede functionality. View the products' version in Management > Version.

• Farm Center

The **Farm Center** provides you maximum capability with minimal complexity in programming and controlling up to 10 **Farm Master Plus** units. The **Farm Center** provides you maximum capability with minimal complexity in programming and controlling up to 10 units. **Farm Center** is the ultimate pig house controller. Equipped with an easy programming interface, it provides programmable outputs for all major features and a 4x20 character LCD that provides display feedback on the programming and device status.

The **Farm Center** communicates with up to ten **Farm Master Plus** units to access history, collect events and alarms for each and all relevant data up to 100 days.

• Farm Master Plus

The user-friendly controller has high performance and quick response time. **Farm Master Plus** features accurate temperature and humidity sensors, secure transmission of data even in noisy environments and the added convenience of eight output relays as well as four analog outputs.

Each **Farm Master Plus** can operate independently, in case of **Farm Center** malfunction or loss of power. Using an internal battery when the **Farm Master Plus** is operating "alone", there is no history collection or possibility to change parameters.

There are three Farm Master Plus models:

- **5020**: No variable speed
- **5021**: One channel variable speed
- **5022**: Two channels variable speed

3.3 Features

Farm Center

- Easy programming
- LCD - 4x20 characters
- Positioning scrollbar
- Swift device and feature selection
- Data plug
- Large numeric keypad
- Communication with up to ten Farm Master Plus units
- Extensive history of events & alarms
- Data Collection
- Real time visual outlook
- Alarm system (for every Farm Master Plus unit)
- Multi language Support
- PC communication

Farm Master Plus

- Easy programming
- Programmable outputs
- Alarm system
- Large display
- Up to 3 temperature sensors
- Up to 8 heavy duty relays (1 HP)
- On/Off/Auto override switches
- Static pressure control (optional)
- 4 Analog output (0-10 volts)
- Variable speed fan output with bypass
- Water, feed, and humidity control
- Automatic calibration of curtains

3.4 Farm Center/Farm Master Plus network connection

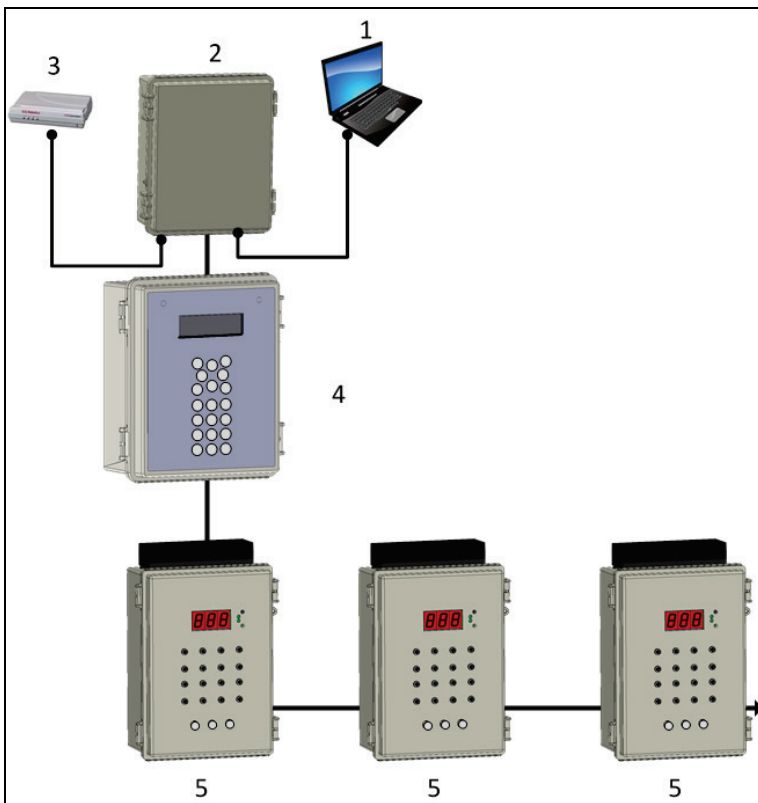

1	Computer
2	MUX
3	Modem
4	Farm Center
5	Farm Master

Figure 1: Farm Center - Master Plus - MUX Network

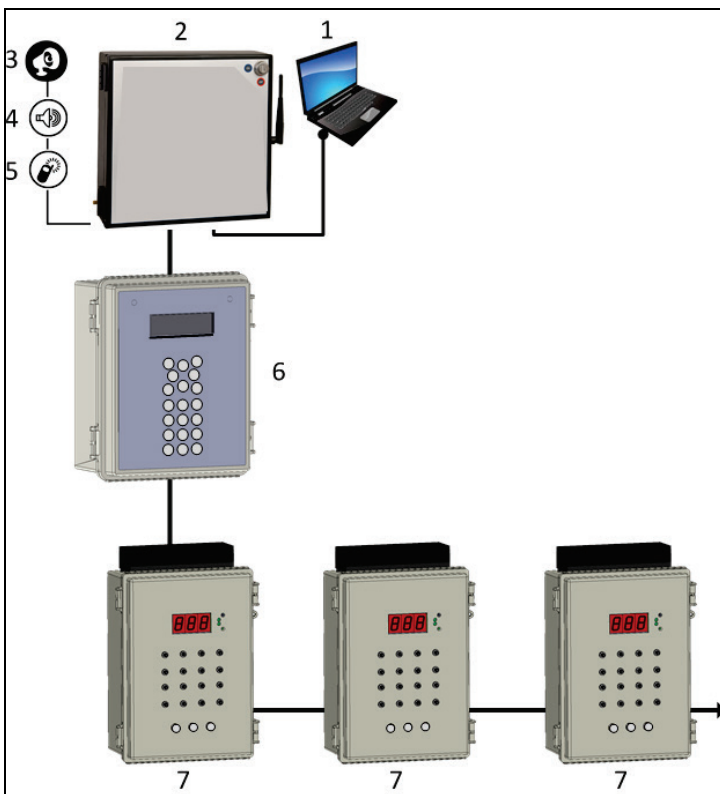

1	Computer
2	Farm Guard
3	Alarms
4	Voice messages
5	Cellular and text messages
6	Farm Center
7	Farm Master Plus

Figure 2: Farm Center - Master Plus - Farm Guard Network

4 Getting started

This quick guide details the order of actions when installing the system:

1. **Hardware Installation:** Read all technical specs and use the wiring diagrams, from page 54 on this manual, to properly install all hardware.
2. **Farm Master Plus Cold Start:** Plug in the controller and hold its three keys simultaneously for a few seconds until a CLD sign will appear. This action erases the memory completely and loads the default definitions.
3. **Farm Master Plus Unit Number:** Press the two arrow keys together until the number sign (no.) blinks. Select the unit number with the up and down arrows and press Select.
4. **Farm Center Cold Start:** Plug in the controller and hold the delete key (DEL) for a few seconds until a Cold Start sign will appear.

This action erases the memory completely and loads the default definitions.

5. **Farm Center setup (Room #0):** Follow the instructions on page 17.

NOTE Before making any changes make sure you are changing the correct room by checking the room number on the upper right side of the screen.

6. **Farm Center Installation:** Follow the instructions from page 45. If you have more than one room, don't forget to change room number and install the rest.
7. **Farm Center Calibration:** Calibrate your equipment on each room using the service menu.
8. **Farm Center Control:** Follow the instructions from page 20 regarding the control parameters for each room.
9. **Farm Center Device:** Follow the instructions from page 30 regarding the device settings for each room.
10. **Farm Center Management:** Follow the instructions from page 36 regarding livestock and alarm management for each room.

The [History](#) menu is for viewing purposes only.

4.1 Farm Center keyboard

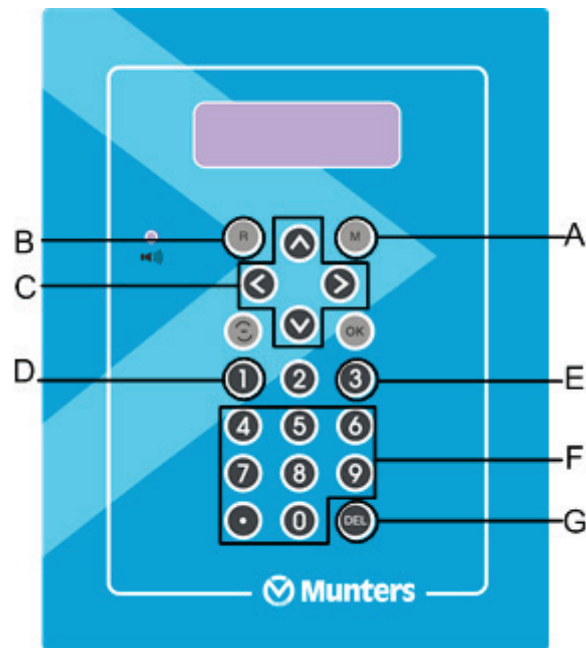

A	Menu	Toggles the menu function
B	Room	The room key is used to switch between rooms. Press the room key and press a number to reach the desired room.
C	Arrows	Use the arrows to scroll a short press in any direction moves one notch.
D	Round Arrows	The Round Arrows key is used to scroll between options (Yes/No, On/Off and '!').
E	Enter	The enter key is a confirmation key.
F	Numeric Pad	The Number keys are selected when a numeric choice is done and when numbers should be selected. Moreover, those keys are used for Hot Keys purposes.
G	Delete	The 'Delete' key erases typing mistakes.

4.2 Farm Center main screen

TEMP	27.1	ROOM	#01
RH%	75.0	DAY	1
TRGT	24.0	Hr.	13:21
RH%T	80.0	LEVEL	1

The Farm Center can display here and in Hot Screen 2:

- inside temperatures as low as -20° C
- outside temperatures as low as -40° C
- inside/outside temperatures as high as +50° C

NOTE The main screen shows basic information regarding rooms controlled by the Farm Center, depending on what equipment is plugged in. Other parameters like static pressure (PRESS), outside temperature (OUT), level, message and offset are also shown on the main screen when they are plugged in. Parameters are shown according to priority. There is a square in level line indicating tunnel level.

TEMP	Current room temperature
RH%	Current room humidity
TRGT	Target temperature
RH%T	Target humidity
OUT	Outside temperature
ROOM #01	Room number
DAY	Growth day
Hr.	Time
LEVEL	Current ventilation level.

CAUTION In case of an alarm, a blinking message will appear on any one of the main screens in addition to the siren. Pressing "0" on the main screen, when the alarm message is on, will direct you to the room with the alarm. Resetting the alarm is possible, but it only stops the siren and not the screen message. Only by fixing the problem will the message stop.

Pressing the zero on the numeric pad, while the alarm is activated will open the room status screen.

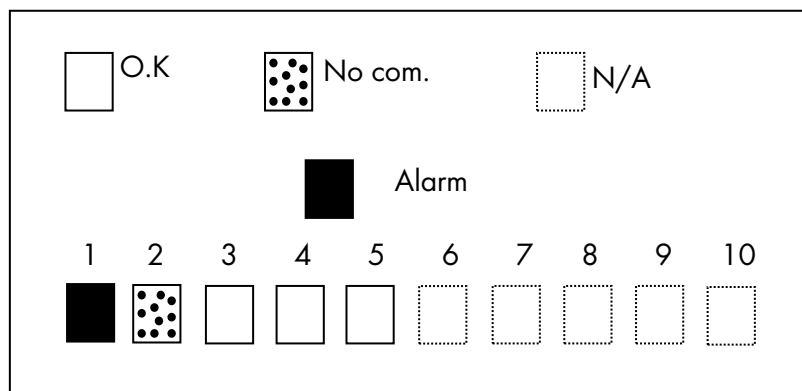

- An empty square indicates that the Farm Center identifies the houses correctly.
- A filled square indicates an alarm is on.
- A dotted square indicates that there is no communication with the **Farm Master Plus**.

NOTE Once communication is off there is no history accumulation in the Farm Center.

- A dotted lined square indicates N/A (not available).

4.3 Hotkeys

To reach the Hotkeys screens, press the Hotkey number while viewing the main screen. The room number is located on the upper right side of the Hot screen to view the status of different rooms, first enter the desired room using the room key and pressing the room number. Then press the desired screen Hotkey number.

- **Hot key 1:** Main screen
- **Hot key 2:** Temperature screen

The temperature hot screen shows important information regarding the status of temperature sensors attached to the Farm Center. The average temperature (defined in table 6.6) is displayed on the upper left side and shows the average of temperature sensors T1 through T3. Table 6.2 enables the user to set the temperature sensor T3 as 'OUT' and therefore T3 presents the outside temperature. On the right side, you can see the temperature for entering tunnel ventilation mode.

T1	24.4	#01	
T2	25.1	AVG.	22.9
T3	22.5	TUN.	23.3
T4	23.3	OUT	31.3

Room Number

The Farm Center can display here and in the Main Screen:

- inside temperatures as low as -20° C
- outside temperatures as low as -40° C
- inside/outside temperatures as high as +50° C
- **Hot key 3:** Targets Screen

This screen shows all of the target levels, selected for any of the controller's functions.

TARGETS	#01		
TEMP	22.5	PRESS	0.01
MIN LEVEL	5	ON	60
MAX LEVEL	15	OFF	240

- **Hot key 4:** Curtain Position screen

This screen shows the curtain opening position in percent. If for example curtain 2 show 40%, it is 40% open.

CURTAIN POSITION	#01		
CURT.1	50	CURT.2	CL
CURT.3	40	CURT.4	-
TUNNEL	OP	INLET	-

- **Hot key 5:** Curtain Steps

This screen shows the number of steps for each curtain.

CURTAIN STEPS		#01	
CURT.1	12	CURT.2	-
CURT.3	14	CURT.3	-
TUNNEL	-	INLET	-

• **Hot key 6:** System Status

This screen shows if humidity treatment is ON/OFF, if the cycle is ON/OFF and how many seconds left for the current cycle.

SYSTEM STATUS		#01	
HUMIDITY TREAT.		ON/OFF	
CYCLE STATUS		ON/OFF	
CYCLE LEFT		29	

• **Hot key 7:** Variable Fans

This screen shows the speed percent of each variable fan.

VARIABLE FANS		#01	
FAN 1	30%	FAN 3	n/a
FAN 2	40%	FAN 4	n/a

• **Hot key 8:** Variable Heat

This screen shows the percent of each variable heat.

VARIABLE HEAT		#01	
HEAT 1		70%	
HEAT 2		n/a	

• **Hot key 9:** Relay Status

This option shows active relays, pressing 9 again will open the extension box's relay activity

RELAY STATUS		#01	
R1- <input type="checkbox"/>	R2- <input checked="" type="checkbox"/>	R3- <input type="checkbox"/>	R4- <input checked="" type="checkbox"/>
R5- <input type="checkbox"/>	R6- <input type="checkbox"/>	R7- <input type="checkbox"/>	R8- <input type="checkbox"/>
EXTENSION RELAYS '9'			

• **Hot key Round Arrow key:** Temperature History

This option shows a summary of temperature according to temperature room. This screen consists of the following columns:

- Day number ('Day' column)
- Minimum value measured on that day ('Min' column)
- Average value calculated on the measured temperatures through the whole day ('Avg' column)
- Maximum value measured on that day ('Max' column)

TEMPERATURE ROOM #1			
DAY	MIN	AVG	MAX
23	21.4	23.5	24.5
24	21.8	24.6	24.7

- **Hot Key:** Ventilation by Weight Hot Screen

This option displays critical parameters connected to the Ventilation by Weight option:

- Current requested calculated air volume per kilo
- Current requested airflow per weight
- Average weight

AIR STATUS	#1
Req. Air Vol.	0
Cur. Air Vol.	0
A. Wg 22.0	Ar. Fl 0.13

NOTE Versions 1.09 or higher support this option. Refer to By Weight, page 23 for more information.

4.4 Farm Center setup

To reach the Farm Center Setup screen:

1. Go to Room key,
2. Press '0' and "Enter" from any of the main screens.

The Farm Center setup is a procedure for customizing the Farm Center and Farm Master Plus units to match the system. Table 1 details the setup parameters.

Farm Center		↑
===COMM.===		
Farm Center#	1	↓
PC.Baudrate	4800	

Total Rooms	5	
=Language=		
Language	►English	
===UNITS===		
Temp.	►F	
Press	►IN.W.C	
Other Units	IMPER	
=OUT TEMP.=		
From Room	►1	
===TIME===		
Time(hh:mm)	►12:06	
=PASSWORD=		
Full Access	0	
Read Only	►0	

Table 1: Farm Center Setup Screen

FARM CENTER	Farm Center identity (Max-32). Define the Farm Center's unit number. If only one Farm Center exists, the unit number is 1. Otherwise, the unit numbers are sequential (1, 2, 3,...).
BAUDRATE	Select communication baud rate with the PC.
TOTAL ROOMS	Set the number of Farm Master Plus units connected to the Farm Center (Max-10). Make sure you define the units' numbers in a following order without skipping digits. For example: 1,2,3,4... If not set this way, the Farm Center will not detect any Farm Master Plus units. After defining the number of Farm Master Plus controllers, the Farm Center begins a search to find the controllers defined.
LANGUAGE	Select language.
TEMPERATURE UNIT	Select between Celsius and Fahrenheit.
PRESSURE	Select between: Milibar, IN.W.C, Pascal, CM.W.C, MM.W.C.
OTHER UNIT	Select between meter and imperial. Controls the speed and rain flow. Units for speed are meter/h or mile/h and for rain millimeter/h or inch/h.
OUT TEMP	Set the outside temperature.
TIME	Set clock time.

PASSWORD	<p>Set passwords to protect data. There are two access levels:</p> <ul style="list-style-type: none"> • Full access. This level enables setting all system parameters. • Read only: This level enables viewing the parameters only. <p>Enter each password. Every time the unit is powered, the user must enter the password.</p> <p>The default is 0 (zero) which disables the password.</p>
----------	---

NOTE The last six parameters are general for all Farm Master Plus units.

4.5 Main Menu

The complete Farm Master Plus main menu structure is described in the table below:

1 CONTROL	2 DEVICE	3 MANAGEMENT	4 HISTORY	5 CALIBRATION	6 INSTALLATION
Temp Curve	Vent Levels	Animal Inv.	Emp	Temp	Relay Layout
Min/Max Level	Var. Fan Levels	Day Group	Hum	Hum	Sensors Layout
Humidity	Curtain Levels	Alarm Setting	Water	Pressure	Dig. Input
Static Pressure	Circulation Fans	Alarm Reset	Feed	Water & Feed	An. Output
System Parameters	Cool Pad	Version	Mortality		Var. Speed fan
Control Mode	Foggers	Read From	Heater		Sensor Def
	Light	Write To	Alarm		Curtain Setup
	Feed		Event		Comm Test
	Ex. Sys.				
	Time Clocks				
	Var. Heat				

5 Control Menu

- Temp Curve
- Min. Max. Level
- Humidity
- Static Pressure
- System Parameters
- Control Mode
- Device

5.1 Temp Curve

TEMP CURVE #01				Heat	Tunnel	Low Alarm	High Alarm
#	Day	Target					
1	1	23.3		21.1	37.2	21.1	37.2
2	14	22.2		20.0	37.2	10.0	35.0
3	42	21.1		18.8	32.2	10.0	35.0
4	70	20.5		17.8	29.4	10.0	35.0
5	98	20.0		16.6	26.6	10.0	32.2
..10							

The Farm Master Plus provides separate temperature curves for growth day, target temperature, heat temperature, tunnel temperature and low/high alarm temperatures. The controller creates a curve for each one and uses it as reference. The program will alter at midnight prior to the next day on the next row programmed. There are up to 10 programmable rows, but the controller will maintain yesterday's settings for every empty line, therefore it is not necessary to fill the entire table.

Limits:

- Day 0 - 999
- Target -20 to +50° C
- Alarm low -20 to +50° C (without floating point)
- Alarm high -20 to +50° C (without floating point)

5.2 Min. Max. Level

The Minimum/Maximum Level menu sets the current absolute minimum and maximum ventilation levels available. There are five minimum/maximum level choices:

- Min/Max by Growth Day
- Soft Min/Max by Day
- Min/Max by Time of Day
- Soft Min/Max by Time
- Cold/Warm (refer to Setting Cold Warm Levels, page 23)
- By Weight (refer to By Weight, page 23)

How do these options work?

- Min/Max by Growth Day and Min/Max by Time of Day define the ventilation by the growth day or time, respectively.
- Soft Min/Max by Day and Soft Min/Max by Time enable decreasing the minimum level of ventilation in extreme cold. For that, the user uses the Soft Min level that operates according to outside or inside temperature. Refer to Soft Min Max by Day Levels, page 22.
- Cold/Warm is used to limit the ventilation levels when temperatures are extremely cold or hot. These settings override any other definitions when temperatures reach the levels defined in the Outside T.Cold and Outside T.Warm parameters (refer to page 27). Refer to Setting Cold Warm Levels, **page 23**.
- By Weight determines the ventilation by the total projected weight of the animals.

By Day		
Day	Min	Max
1	1	21
14	3	30
98	9	30

Soft Minimum By Day			
Day	Min Cold	Min Warm	Max
1	1	11	25
14	3	13	30
98	9	19	30

Soft Minimum By Time			
From Time	Min Cold	Min Warm	Max
8:00	1	7	25
20:00	3	5	23

By Time		
From Time	Min	Max
8:00	1	21
20:00	3	21

Cold/Warm			
Day	Min Level	M/C	M/W
1	1	02	25
14	3	13	30
98	9	19	30

5.2.1 Soft Min Max by Day Levels

Day	Min Cold	Min Warm	Max
1	1	10	30

System parameters -> Min/Max

Level control	DSFT (Soft Min by days)
Soft Min temp	Out (Control by outside temperature)
Soft Min Band	2.2° C (Differential below heat temperature)

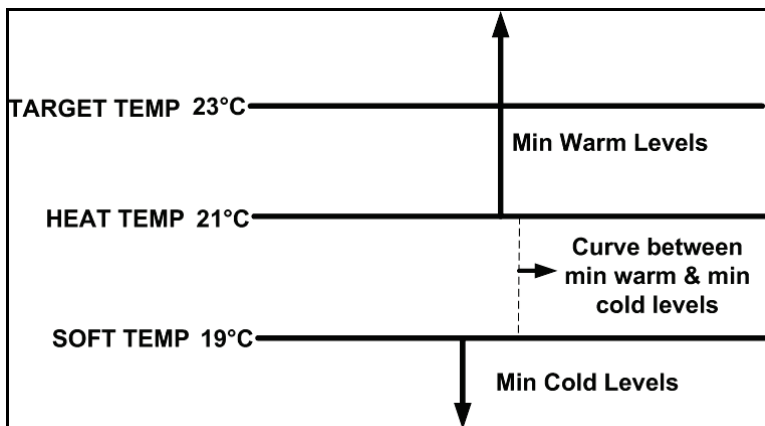

If the inside temperature is above 21 °C (heat temperature) the controller will operate according to the Min Warm levels.

If the inside temperature is below 19 °C (Soft Temp) the controller works according to Min Cold levels. When the temperature is between 21 °C and 19 °C the controller creates a curve between the Min Cold and Min Warm levels. For example, in 20 °C the controller operates in level 5.

Important:

- When using Soft Min according to **inside** temperature there is a curve between min warm and min cold, while decreasing levels. When temperature increases the level remains at the lowest level reached, until reaching the heat temperature.

- When using Soft Min according to **outside** temperature there is a curve between min warm and min cold while decreasing and increasing levels.

To select the type of minimum/maximum go to system parameters and change the level control (see page 25).

5.2.2 Setting Cold Warm Levels

To set Cold/Warm Vent levels:

11. Go to Control > System Parameters > Outside T.Cold.
12. Set the outside cold temperature (default: -5° C, minimum -20° C, maximum +20° C)
13. Go to Control > System Parameters > Outside T.Warm.
14. Set the outside warm temperature (default: +20° C, minimum 0° C, maximum +40° C)
15. Go to Control > System Parameter > Level Control.
16. Select C/W.
17. Go to Control > Min. Max. Level
18. Enter the required ventilation levels.

5.2.3 By Weight

The By Weight option enables controlling the minimum air flow depending on the number of pigs, their weight and the current outside temperature. When using the Weight option, Farm Center takes several parameters and calculates the air speed, level of ventilation and cycle time needed to supply the required volume. As opposed to the other ventilation methods, the Weight option is dynamic, with the ventilation changing according to the current parameters (quantity of air required, weight of animals and number of pigs, outside air temperature). In addition, Ventilation by Weight sends out an alarm if the current ventilation is below the minimum required level.

NOTE This option is available in Version 1.09 and higher.

To set up the Weight Option:

1. In the Install > Fan Air Capacity menu, define the air capacity / hour (page 49).
2. In the Control > Min. Max Level menu, select **By Weight**.
3. Set the parameters as required.

SOFT MIN/MAX LEVEL BY WEIGHT (OUT TEMP)					
Day	Min Level	Air Per Kg/Lb		Max Level	Animal Weight
		Cold	Warm		
1	1	0.5	1.5	16	4.0
3	1	0.5	1.5	16	15.0
6	1	0.5	1.5	16	30.0
10	4	1.1	1.7	16	45.0
12	4	1.1	1.7	21	55.0
15	7	1.1	1.7	21	80.0
17	7	1.1	1.7	21	120
19	7	1.1	1.7	21	170
21	7	1.1	1.7	21	240

- **Day:** Set growth day
- **Min Level:** Set the minimum level of ventilation (refer to Vent Levels, page 30) default: 1; range 1 - 30

- **Air Per Kg/Lb:** Volume of air per kilogram/pound per hour per pig.
 - Cold: Volume of air supplied when the outside temperature goes down to the *Cold Temperature* parameter (see the following section).
default : 0.5; range 0.1 - 99.9
 - Warm: Volume of air supplied when the outside temperature reaches *Warm Temp. - Diff Below Heat* (see the following section).
default : 0.5; range 0.1 - 99.9

NOTE As the level rises between days (for example between day 6 and day 10 in the screen above), the air volume rises proportionally each day, once a day. For example, on Day 7, the Cold Air per Kg/Lb rises to 0.65; on Day 8, 0.8 and so on.

- **Max Level:** Set the maximum level of ventilation (refer to Vent Levels, page 30).
- **Animal Weight Curve:** This curve enables defining the animal average weight per day. The curve provides the day's current animal weight to be used when calculating the total livestock weight:

Total Weight = (Average Animal Weight) x (Total Animals Count)

default: 10.0; range 1.0 - 999

4. In the *Management > Animal Inventory* menu, type the number of pigs.

Ventilation by Weight is configured.

5.3 Humidity

HUMIDITY #01	
Target	0
Delay (minute)	0
Duration (sec)	0
Band (%)	2
Dif From Heat	0.0

- **Target:** Set the humidity target for.
- **Delay:** delay time before humidity treatment. The controller checks during the delay time whether the humidity is above the target.
- **Duration:** humidity treatment duration time.
- **Band:** band zone to balance the treatment.
- **Below heat:** select if you wish to initiate humidity treatment below heater temperature.

5.4 Static Pressure

STATIC PRESSURE #01	
Out temp low	5
Press. (low t)	0.12
Out temp high	35
Press. (high t)	0.08
Tunnel press.	0.08

Low alarm	0.05
High alarm	0.15
Band	0.04
Wind delay (s)	10
Pre open (s)	5
Alarm MINIMUM level	0

- **Out Temp low:** Set outside low temperature definition for low pressure target.
- **Press (Low T):** Static pressure target for the outside low temperature (See graph below, point 1).
- **Out Temp High:** Set outside high temperature definition for high pressure target.
- **Press (High T):** Static pressure target for outside high temperature (See graph below, point 2).
- **Tunnel Pressure:** Static pressure target during tunnel ventilation mode.
- **Low Alarm:** If static pressure drops below set point alarm will be active.
- **High Alarm:** If static pressure rises above set point alarm will be active.
- **Band:** Set band zone to balance the system.
- **Wind Delay:** Static pressure is affected by wind; this definition ensures an alarm is given due to a stable change in pressure and not an accidental one, one that may have been caused by a wind gust.

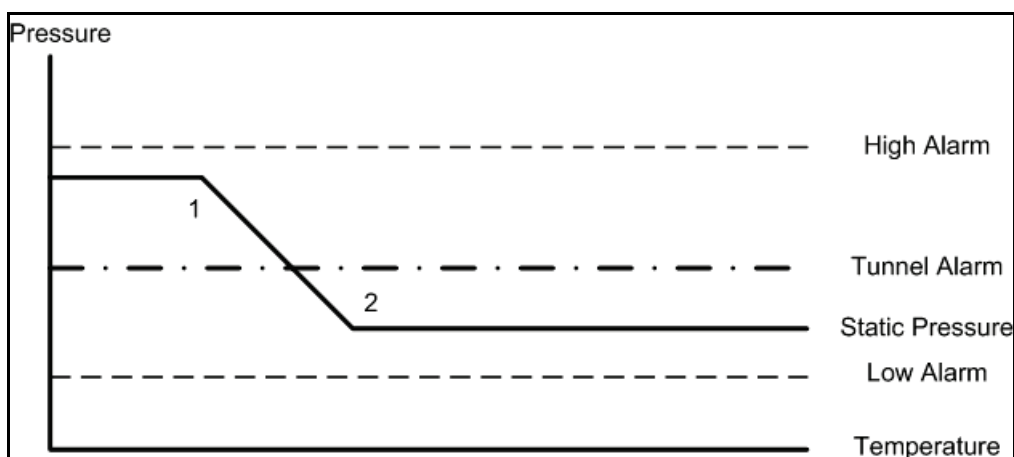

- **Pre Open:** Time setting for curtains to open before fans activate. This is to make sure the curtains are open before fan activity.
- **Alarm minimum level:** From what level you wish to activate low static pressure alarm.

5.5 System Parameters

SYSTEM PARAMETERS	
=====TEMP=====	
Offset▶	0.0
Band	1.0
Cool Factor	10%
Cold Above TRG	3.0
Cold Below TRG	1.0

```
====HEATER====
Heat Band 1.0
Heat Lamp Diff 0.0
Heat Offset ??
====MIN MAX====
Curve NO
Level Control Day
Soft Min Temp OUT
Soft Temp Band 10.0
Outside T.Cold -5
Outside T.Warm +20
====Press====
Press Control No
====LEVELS====
Inc Delay (s) 120
Dec Delay (s) 180
====TUNNEL====
1st Tunn Level 0
Dif Below, Exit 2.0
T.Out Dif, Exit 0.0
Exit Delay (m) 5
===CURTAINS===
Calib Steps 99

===INLETS===
Power Fail Cal NO
==COOL PAD==
From Level 0
Temp Band 1.0
Humidity Band 2.0
====FOGGERS====
From Level 0
Temp Band 1.0
Humidity Band 2.0
===VAR. FAN===
Freeze Protect NO
Fan Cycle High
Min Motor1 Spd 30
Min Motor2 Spd 30
Min Motor3 Spd 30
Min Motor4 Spd 30
```

===VAR. HEAT===	
Temp. Diff	NO
Temp. Band	0.0
Min Heat	30%

NOTE Min Motor appears in Version 1.09 and below

Parameter	Default
TEMP	
Offset: Use this parameter to change the offset target temperature up or down for any purpose.	0.0
Band: This refers to the target temperature zone range. The User's Manual refers to this as the Happy Zone.	1.0
Cool Factor (%): The minimum correction towards target happy zone during each increase ventilations delay (patience factor). If the temperature does not improve by this amount, the controller will increase one level.	10%
Cold Above TRG: Temp change to be considered as quick drop in degrees, to reduce a level to reach above target temp (degrees).	3.0
Cold Below TRG: Temp change to be considered as quick drop in degrees, to reduce a level to reach below target temp (degrees).	1.0
HEATER	
Heat Band: Set the happy zone for the heaters on/off.	1.0
Heat Lamp Diff: Differential from target temperature to initiate heat lamps.	0.0
Heat Offset: Use this parameter to change the offset Heat temperature up or down for any purpose.	0.0
MIN MAX	
Curve: If Yes - Min max table curve between the days. If No: Works according to previous line until current day	NO .
Level Control: Four options for the min max table method: by days, soft minimum by days, by time, soft minimum by time.	Day
Soft Min Temp: Choose whether to use the current inside temperature or the outside temperature to determine when to use the soft minimum.	OUT
Soft Temp Band: Difference below heat temperature to set temperature at which to enforce low temperature minimum ventilation level.	10.0
Outside T.Cold: This parameter defines the temperature below which ventilation is reduced to the minimal level defined when using Cold/Warm Min Max Ventilation.	5° C
Outside T.Warm: This parameter defines the temperature above which ventilation is increased to the minimal level defined when using Cold/Warm Min Max Ventilation. +20° C	
PRESSURE	
Press Control (Yes / No): If a pressure control should be done in Min Vent mode by the inlet and in Tunnel mode by tunnel curtain, select Yes . Otherwise, select No .	No.
LEVELS	

Inc Delay Time: This is the standard minimum delay before increasing ventilation levels.	120 (sec)
Dec Delay Time: This is the standard minimum delay before decreasing ventilation levels.	180 (sec)
TUNNEL	
1st Tunnel Level: Switching into and out of tunnel ventilation is a major change in ventilation. For tunnel ventilation, enter the first tunnel level here. If set to 0 there is no tunnel level.	0
Dif Below, Exit: This parameter sets amount below the tunnel entry temperature at which to exit tunnel ventilation. Tunnel temperatures are determined by the sensors specified in Temperature Definition. Entry and exit is also controlled by these sensors. The controller cannot exit tunnel until the tunnel temperature is this much less than the tunnel entry temperature. It must be a positive number.	2.0
T.Out Dif, Exit: Set the relative temperature for the outside sensor at which to exit tunnel. The controller cannot exit tunnel until the outside temperature is less than tunnel temperature plus this differential. This number can be positive or negative. To eliminate the effect of this parameter on tunnel exit, enter a large positive number such as 90.0.	0.0
Exit Delay (m): Delay time after satisfying tunnel exit conditions.	5 (minutes)
CURTAINS	
Calibration Steps: To ensure accurate positioning of the curtains, the controller may periodically calibrate the curtain position. This parameter sets the maximum number of curtain movements or stages between calibrations. Calibration consists of forcing the curtain to the nearest limit, 0% or 100% with adequate overtime to ensure reaching the limit switch. Then the curtain returns to its proper position. In the event several curtains require calibration, they calibrate one at a time to reduce the amount of restriction to normal ventilation. The stage counter resets automatically each time the curtains reach a limit point to prevent excessive calibration.	99
INLETS	
Power Fail Calibration: When set to yes, Farm Center automatically resets (calibrates) the inlet after a power failure or power reset. The inlet opens completely and then closes according to the static pressure at the required position.	No
COOL PAD	
From Level: From which ventilation level to begin cool pad operation. 0 is no operation.	0
Temp Band: On/off differential or Happy Zone with respect to temperature for the 'Cool #' and 'Cool Pad #' relays. These normally control the water pump for the cool cells.	1.0
Humidity Band: On/off differential or Happy Zone with respect to inside humidity for the 'Cool #' and 'Cool Pad #' relays.	2.0
FOGGER	
From Level: From which ventilation level to begin fogger operation. 0 is no operation.	0
Temp Band: See cool pad above.	1.0
Humidity Band: See cool pad above.	2.0
VAR. FAN	
Freeze Protect: A general protection for the variable speed fan motor. When the variable speed fan starts from zero speed, the freeze protection activates it to 100% for 5 seconds.	No
Min Motor 1, 2, 3, 4 Spd: Safety speed fan operation delay. This is the fan minimum speed to begin operation. .	30
<i>NOTE Min Motor appears in Version 1.09 and below. To enable the fans, refer to</i>	

<i>Variable Speed Fan, page 47. Users having Version 1.10 and above, refer to TRIAC Calibration, page 51.</i>	
Fan Cycle: Enables cycle operation in cold temperatures when set to Low..	High
VAR. HEAT	
Temp. Diff: Differential from heat temperature to initiate variable heaters.	0.0
Temp. Band: Temperature range in which the variable heater operates in the power range between minimum and 100%. For example: the heater temperature is 80°F, the temp diff is -1 and the temp band is 2. At 79°F the heater will operate at minimum power according to minimum heat. At 77°F and down the heater will operate at 100% and between 79°F and 77°F there will be a power band between minimum and 100%.	0.0
Minimum Heat: Minimum heaters operation for safety measures. This parameter refers to both var. heat 1 and var. heat 2.	30%

5.6 Control Mode

CONTROL MODE #01
Set Mode ▶Normal
Empty

In this screen control mode can be set, choosing between Normal mode and Empty mode.

Empty mode is applied in cases of empty houses.

When Empty mode is selected:

- All alarms will be disabled
- A flashing message will appear while displaying temperature.
- "E" In Farm Master Plus and "Empty House" in Farm Center.

Setting controller to Normal or Empty mode inserts an event to History/Event table

6 Device menu

The following sections detail the Device Menu.

- Cycle Operation
- Vent Levels
- Variable Fan Levels
- Curtain Levels
- Circulation Fan
- Cool Pad
- Foggers
- Light
- Feed
- Extra System
- Time Clocks

6.1 Cycle Operation

The Vent Levels and Variable Fan Levels features enable Cycle Operation. Cycle Operation means that the fans operate at two levels, minimum and maximum. When the cycle is off, the fans run at the minimum level. When the cycle is on, the fans run at maximum level.

To enable Cycle Operation:

1. In *Control > System Parameters > Var. Fan*, set the Min Motor Speeds (up to 4).
2. In *Control > System Parameters > Var. Fan*, set the Fan Cycle to High (default) or low.
 - High: Maximum level is 100%; minimum level is user-determined.
 - Low: Maximum level is user determined; minimum level is zero.

NOTE In Low, the maximum level is the **Minimum Motor Speed**.

6.2 Vent Levels

The Farm Center provides up to 30 programmable ventilation levels.

NOTE When employing the Ventilation by Weight option, the On/Off times don't appear.

VENT LEVELS #01				
#	12345678	on	Off	Diff
01	●	30	240	0
02	◐	40	220	0
30	■			

The usual way to program them is to start the first level with the least amount of air to be used.



The full circles represent continuous fan operation.



The half full circle represents cycle operations according to the on/off time set for each stage.



A dot represents no operation at all.

The following table is an example of a proper ventilation setting. Note that tunnel is not noticeable on the current table and is set according to the system parameter- 1st tunnel level.

Lev	Tunnel Fans								On	Off	Diff
	1	2	3	4	5	6	7	8			
1	◐	◐							30	570	0.0
2	◐	◐							40	560	0.0
3	◐	◐							52	548	0.0
4	◐	◐							70	530	0.0
5	◐	◐							90	510	0.0
6	◐	◐							30	270	0.0
7	◐	◐							40	260	0.0
8	◐	◐							52	248	0.0
9	◐	◐							70	230	0.0
10	◐	◐							90	210	0.0
11	◐	◐							120	180	0.0
12	◐	◐							160	140	0.0
13	●	●	◐						225	75	0.0
14	●	●	◐						300		0.0
15	●	●	◐						100	200	0.0
16	●	●	◐						70	230	0.0
17	●	●	◐						90	210	0.0
18	●	●	◐						120	180	0.0
19	●	●	●						160	140	0.0
20	●	●	●	●					225	75	0.0
21	●	●	●	●					0	0	0.0
22	●	●	●	●	●	●			0	0	1.0
23	●	●	●	●	●	●			0	0	2.0
24	●	●	●	●	●	●	●		0	0	3.0
25	●	●	●	●	●	●	●		0	0	4.0
26	●	●	●	●	●	●	●		0	0	5.0

6.3 Variable Fan Levels

This screen sets the variable fan levels.

SPEED (%) #01					
#	Fan 1	Fan 2		Fan 3	Fan 4
01	30 ●	32 ●		0	0
02	20 ◐	25 ◐		0	0
...30					



The percentage for a full circle represents the fan operation percentage from the maximum. If set on 30% it will operate up to 30% of the maximum.



The percentage for a half full circle represents the fan operation percentage in off mode during cycle operation.

6.4 Curtain Levels

This screen sets the levels to which the curtains are opened.

CURTAIN (%) #01						
#	Crt. 1	Crt. 2	Crt. 3	→ Crt. 4	Tun.	inlet
01	0	0	0	0	0	15
02	0	0	0	↓ 0	0	15
...3	0	0	0	0	0	15
0						

Curtain Level Example						
Level	Curtain (% Open)					
	1	2	3	4	Tunnel	Inlet
	0	0	0	0	0	15
Levels 1 thru 17	·	·	·	·	·	·
	·	·	·	·	·	·
	·	·	·	·	·	·
	0	0	0	0	0	15
18	0	0	0	0	30	
19	0	0	0	0	45	
20	0	0	0	0	70	
21	0	0	0	0	100	

Set the curtain levels to correspond with the ventilation levels. Some producers will want to open the tunnel curtain somewhat prior to the actual tunnel. This is convenient to control pressure in retrofit houses which may not have sufficient side inlets for the number of fans required in side ventilation.

You can also optionally run the tunnel curtain under pressure control. In that event, the percent open settings become minimum settings. Then, once the side vents are at 100%, if pressure requires, the Master opens the tunnel curtain to maintain the pressure setting.

6.5 Circulation Fan

The circulation fans will mix the air inside the house and control temperature differentials between different parts of the house.

CIRCULATION FAN #01	
Sensors Dif	3.0
From Time	00:00
To Time	00:00
From Level	1
To Level	10

- **Sensors Dif:** The circulation fan starts if the difference between temperatures in different parts of the house is higher than the set differential. The sensors that participate in this differential can be divided into three groups:
 - If no sensors are set for circulation fans in temp definition, the current defined sensors will control this operation. If for example the house is in tunnel mode, the tunnel sensors will control the circulation fans. If there will be difference higher than three (like the example above) between two sensors the circulation fans will begin to operate.
 - If one sensor is defined for the circulation fans, the difference between this sensor and the average will control the circulation fans.
 - If more than one sensor is defined for the circulation fans, when the difference increase between any two sensors, the circulation fans will begin operation.
- **From Time:** from what time to start the application.
- **To Time:** to what time operate this application.
- **From Level:** from what level to operate this application.
- **To Level:** up to what level operate this application.

If any of the four definitions above is set on 0, the circulation fan will operate at any time or level according to the differential.

6.6 Cool Pad

The cooling table provides settings for the evaporative cool pad system. There are up to five fragments allowing precise control over this system. Several fragments can be selected for the same day.

Cool Pad #01							
#	From	To		Diff	%RH	On	Off
1	08:00	20:00	→	3.0	85	30	90
2	10:00	18:00		5.0	75	60	60

- **From:** (HH:MM) Start time / **To:** (HH:MM) End time.
- **Diff:** Differentiation from the tunnel temperature to activate cooling. When temperature raises this amount above the tunnel temperature, cooling process begin. When the temperature goes back to the tunnel temperature, cooling process stops.
- **%RH:** As long as the humidity + Band are below this level the cooling operates. Cooling stops only at humidity level + band. (See figure below)
- **On/off:** (sec) On/Off cycle by seconds.
- **Band:** The cooling table has its own 'happy zone' for temperature and humidity that can be set at the system parameters under cooling section. The cooling system turns on the amount above specified in the column 'Diff' and turns off when the temperature drops the amount specified in the band.

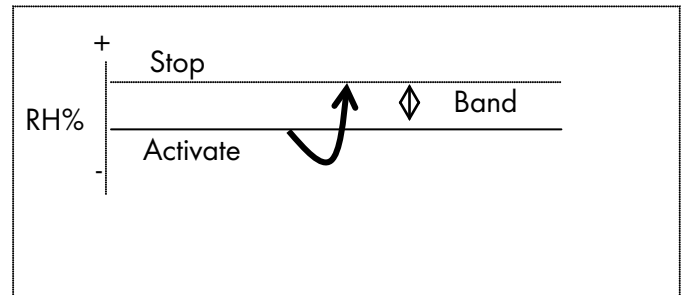
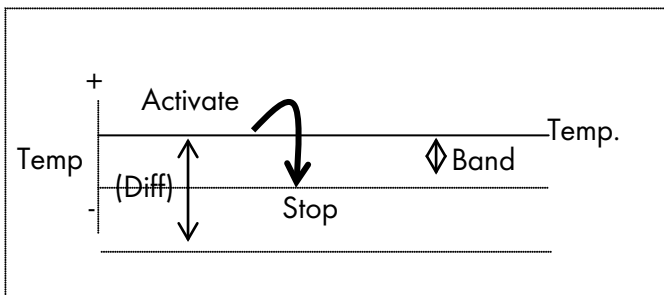

6.7 Foggers

The Foggers' table provides settings for the fogger system. There are up to five fragments allowing precise control over this system. Several fragments can be selected for the same day

Foggers #01							
#	From	To		Diff	%RH	On	Off
1	08:00	20:00		3.0	85	30	90
2	10:00	18:00		5.0	75	60	60

- **From:** (HH:MM) Start time / **To:** (HH:MM) End time.
- **Diff:** Differentiation from target temperature to activate foggers. When temperature raises diff above target, fogger's process begins. When temperature reduces back to target, the fogger's process stops.
- **%RH:** As long as the humidity + Band are below this level the foggers operates. Foggers stop only at humidity level + band.
- **On/Off:** (sec) On/Off cycle by seconds.

6.8 Light

This screen sets the light on/off times according to growth days. There are up to five programmable lines.

LIGHT			
#	Day	From	To
1	1	14:00	12:00
2	5	10:00	16:00

6.9 Feed

Set from what hour to what hour you want the feeding to take place, there are up to five programmable lines

FEED			
#	Day	From	To
1	5	10:00	12:00
2	10	14:00	16:00

6.10 Extra System

Any relay can be set as an extra system. There are up to three functions (relays) available to program as extra system.

EXTRA SYSTEM #01							
#	From	To		From T.	To T.	on	off
1	10:00	12:00		15	40	20	50
2	14:00	16:00		15	50	30	60

The extra system's relays will activate according to the settings in this table and regardless of the conditions, or other devices.

- **From:** (HH:MM) Start time. / **To:** (HH:MM) End time.
- **To/From Temperature (From T./To T.):** the temp range for extra system activity.
- **On/Off:** (sec) On/off cycle by seconds.

This table consists of up to five programs.

6.11 Time Clocks

This is a simple device definition table with operation time and cycle. There are up to 5 functions (relays) available to program as time clocks.

TIME CLOCKS #01					
#	From	To		on	off
1	10:00	12:00		20	50
2	14:00	16:00		30	60

7 Management menu

- Animal Inventory
- Alarm Reset
- Write To Plug
- Day & Group
- Version
- Alarm Setting
- Read From Plug

7.1 Animal Inventory

This table provides an update for animal inventory.

ANIMAL INVENTORY #01	
Add Mortality	2
Animal Placed	1000
Animal Update	998

- Add Mortality: insert mortality.
- Animals Placed: insert animals placed.
- Animal Update: update number of animals.

NOTE In case the wrong figures are entered, it is possible to correct them by entering negative figures.

7.2 Day & Group

DAY & GROUP #01	
Growth Day	2
New Group	Yes/no
Group No.	4

Day and group keeps monitor the growth of groups

- **Growth Day:** Set the number of growth day. This parameter can also help determine the animals age.
- **New Group:** To start a new group, select YES under new group fragment and the controller will automatically increase group number by one and set growth day to 1.

CAUTION When starting a new group, history will be deleted!!!

- **Group No.:** You can manually change the group number.

7.3 Alarm Setting

ALARM SETTING	
Alarm Delay	↕
=SENSOR ALARM=	
Low Alarm Diff	
Hi. Alarm Diff	18.0
====HIGH TEMP=====	
Out	0.0
Compensate	
Emergency	35
Temp	
====LOW TEMP=====	
Var Fan Stop	NO
=====WATER=====	
Min	0
Water/hour	
Max	0
Water/hour	
=====FEED=====	
Min Feed/hour	0
Max Feed/hour	0
====Aux. Alarm====	
Aux Relate f()	NONE

- **Alarm Delay (sec):** represents the number of seconds between failure detection and the alarm operation.

NOTE If the problem is solved before the delay time ends, an alarm will not be recorded in the history log.

- ==SENSOR ALARM==
 - **Low/High:** High and low temperature ranges beyond which alarm is activated.
- ==HIGH TEMP==
 - **Out Compensation:** This parameter is added to the high temperature alarm when outside temperatures are high, like noontime in desert countries. Ensuring you won't get an alarm just because it's a hot day. The emergency temperature has no compensation, so the compensation feature only works when temperatures do not exceed the emergency temperature.

Example: Outdoor+comp.> Alarm then Alarm = Outdoor+Comp.

For example: If the preset compensation is 1 °C, the outside temperature is 24 °C and alarm is set to 25 °C, the controller adds the outside temperature to the comp, and the alarm will rise to 26. (25+1=26)

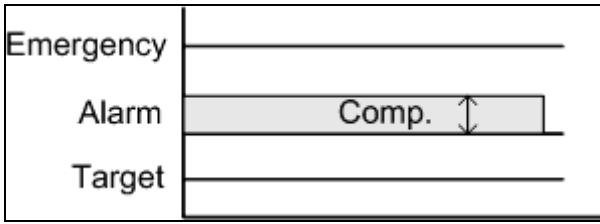
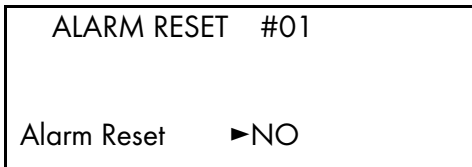

Figure 3: Out Temperature Compensation

- **Emergency Temp.:** The temperature beyond which the controller goes into emergency mode and an alarm is activated.
- **==LOW TEMP==**
 - **Variable Speed Stop (Yes/No):** When in low temperature alarm, decide whether to keep variable speed in minimum operation or totally shut down the function.
- **==WATER & FEED==**
 - **Min/Max Water/Hour:** A quantity of water per hour, above which alarm will activate.
 - **Min/Max Feed/Hour:** A quantity of feed per hour, above which alarm will activate.
- **==AUX. ALARM==**
 - When assigning a related function, alarm occurs if the associated digital input fails to follow the relay. Digital input must be active when its associated relay is on. If there is no related function the alarm turns on when digital input is active.

7.4 Alarm Reset

This screen resets the alarms.



To reset the alarm press Enter and use the Round Arrows key to change from NO to YES.

7.5 Version

Use this window to check the controller's software version.

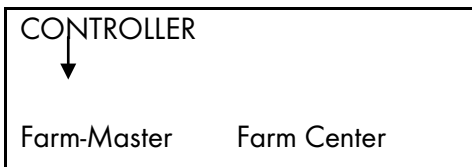

Use the arrow keys to switch between controllers and press select to view the software version.

7.6 Read From Plug

There are two types of data plugs regular and gold. The gold data plug can store up to eight different settings. By naming each setting differently you can easily write/read data from the plug to the controller and vice versa.

```
Read from Plug?
NO<      YES
```

Use the arrow keys to shift from NO to YES and press Enter to read from data plug.

```
DATA ON THE PLUG
Name: Room No. 1
Ver.: 1.00r01
OK->ENTER, Abort MENU
```

Before loading the setting, you can view setting name and software version for this setting. Press enter to load the data on the controller. To cancel reading from this setting, press MENU.

```
READING FROM PLUG
-----
PLEASE WAIT
```

Gold data plug

```
SELECT SETTING #1
Room No.1
Room No.2
<NO SETTING>
...8.
```

7.7 Write To Plug

```
Write to Plug?
NO<      YES
```

Gold data plug

```
SELECT SETTING #1
Room No.1
Room No.2
<NO SETTING>
...8.
```

Use the arrow keys to shift from NO to YES and press Enter to write over the data plug.

You can name your current configuration by using the arrow keys.

On the Gold Data plug, select **NO SETTING** to create a new setting or overwrite an existing one.

```
ENTER SETTING NAME
Name: Room No. 1
To Change ARROWS
OK->ENTER, Abort MENU
```

Press enter to load data to the plug.

8 History menu

The history section maintains a memory of activity of the last 100 days and 100 events or alarms.

- Temperature
- Humidity
- Water
- Feed
- Mortality
- Heater
- Alarm
- Event

8.1 Temperature

TEMPERATURE #01			
DAY	MIN	AVG	MAX
1	24.5	25.8	26.5
2	24.0	25.0	26.5
.			
100			

8.2 Humidity

HUMIDITY #01			
DAY	MIN	AVG.	MAX
1	55.0	60.0	67.0
2	55.0	60.0	66.0
.			
100			

- **Sensors:** Data collection for minimum, maximum and average in temperature and humidity for the last 100 days.

8.3 Water

WATER #01		
DAY	DAILY	%
1	0.0	N/A
2	0.0	N/A
.		
100		

- **DAY:** Growth day.
- **DAILY:** Daily consumption.
- **%:** Percent change from previous day.

8.4 Feed

FEED #01		
DAY	DAILY	%
1	0.0	N/A
2	0.0	N/A
3	0.0	N/A
.		
100		

- **DAY:** Growth day.
- **DAILY:** Daily consumption.
- **%:** Percent change from previous day.

8.5 Mortality

MORTALITY #01		
DAY	DAILY	TOTAL
1	0	N/A
2	1	1
.		
1 100		

- **DAY:** Growth day.
- **DAILY:** Daily mortality.
- **TOTAL:** Mortality total since growth day one.

8.6 Heater

HEATER ROOM #01		
DAY	Heat 1	Heat 2
1	01:05	00:00
2	00:42	00:00
.		
100		

The history heater displays the amount of HH:MM the heater was on that day.

8.7 Alarm

ALARM #01			
	MESSAGE	TIME	DAY
■	Press. Fail	18:50	18
▣	High Temp	10:45	14

The following is an example of an Icon status that indicates activation of alarms.

- NOT ACTIVE
- AN ALARM THAT WAS RESET
- ACTIVE

There are 21 different possible alarm messages:

- Ana. In Fail - analog input failure
- High Temp - high temperature alarm
- Low Temp - low temperature alarm
- Hum.Sen Fail- humidity sensor failure
- Lost Comm- lost communication
- W. Overflow- water over flow
- F. Overflow- feed over flow
- Sn. 1 Fail - Sensor #1 failure.
- Sn. 2 Fail
- Sn. 3 Fail
- Sn.1 Def Err- sensor definition error
- Sn.2Def Err
- Sn.3 Def Err
- Sn.1 Out Rng- sensor out of range
- Sn.2 Out Rng
- Sn.3 Out Rng
- Sn. Not Def- sensor not defined

- Aux Alarm- auxiliary alarm.
- Press. Fail
- Low S. Press.
- High S. Press.

8.8 Event

EVENTS ROOM #1			
	EVENT	DAY	TIME
1	Menu #11	2	18:53
2	Power up	4	14:42

Besides the menu # event message there are three kinds of events:

- **Power up:** How many times the controller was turned on.
- **Reset:** How many times the controller was reset.
- **Cold:** How many cold starts were performed.
- **Menu#:** Which menu number has been changed.

The events table is similar to the alarms table but without icons. For example: In the table above "menu #11" means that there was a change of settings in CONTROL menu 1, Temp Curve table.

9 Calibration menu

• Temperature

• Humidity

• Pressure

• Water & Feed

9.1 Temperature

TEMP. CALIB. #01
Temp-1(Factor)▶ 0.0
Temp-2(Factor) 0.0
Temp-3(Factor) 0.0
Temp-4(Factor) n/a

The temperature sensor is a very accurate sensor with a deviation of 0.1. If needed, calibrate the temperature sensor by using a very accurate reference instrument and enter the offset number for each sensor in the Temp factor line. Use the up and down arrow keys to select sensors.

9.2 Humidity

HUM. CALIB. #01
Humid.(factor)▶ 0.0

If needed, calibrate the humidity sensor by using a very accurate reference instrument and enter the offset number in the Humidity factor line.

9.3 Pressure

PRESS. CALIB. #01
Value A/D
Press ENTER to calib

9.4 Water & Feed

Water/feed #01
Water per pulse 0.1
Feed per pulse 1.0

The water and feed system operates on a pulse counting method. Enter the amount of feed/water per pulse.

10 Installation menu

The following sections detail how to configure the Farm Center software. For details on the physical installation, refer to Mechanical installation guide, page 55.

- Relay Layout
- Sensors Layout
- Digital Input
- Analog Output
- Variable Speed Fan
- Sensor Definition
- Curtain Setup
- Fan Air Capacity

10.1 Relay Layout

RELAY LAYOUT #01	
#	FUNCTION
01	Heater 1
02	Heater 2

Each relay can be defined to any of the functions on the following list:

- None
- Heater 1-2
- Heat lamp 1-2
- Fan 1-8
- Cool Pad
- Foggers
- Curt. 1-4 open
- Curt. 1-4 close
- Tunnel open
- Tunnel close
- Inlet open
- Inlet close
- Light
- Feed
- Circulation
- Extra system 1-3

- Timer 1-5

10.2 Sensors Layout

ANALOG INPUT #01		OPTIONS
Temp-1	IN	IN / NONE
Temp-2	NONE	IN / NONE
Temp-3	NONE	IN / NONE
Temp-4	OUT	NO / YES/OUT
Humidity	YES	NO / YES

The Sensor Layout accommodates up to four temperature sensors and one humidity sensor. Three can be defined for use inside the house and up to one can be used out of the house. Just mark "IN" for a temperature sensor connected in the house and OUT for a temperature sensor outside of the house.

NOTE Only Sensor number 4 can be 'Out'.

10.3 Digital Input

In this screen, set the digital inputs to one of the following:

- None
- Water
- Feed
- Aux. Alarm

DIGITAL INPUT #01		OPTIONS
Input-1	Water	None / Water / Feed / Aux. Alarm
Input-2	Feed	
Input-3	None	

AUX. ALARM: Once operating function, a digital input is sent to make sure that it is actually on, and if not the alarm starts.

10.4 Analog Output

- Variable Heat (up to 2)
- Variable Fan (up to 4)
- Damper (up to 4)

ANALOG OUTPUT #01			
#	FUNCTION	0%	100%
1	Var. Heat 1	0.0	10.0
2	Var. Heat 2	0.0	10.0
3	Var. Fan	3	
4	Var. Fan	4	
5	Var. Fan	3	
6	Var. Fan	4	
7	Damper	1	
8	Damper	2	
9	Damper	3	
10	Damper	4	

Use the Round Arrows key to run through the list of outputs and press enter to select an output.

10.5 Variable Speed Fan

This screen enables variable speed fans. This table fills out according to the number of TRIACs in your system (0 - 2).

Version 1.09 and below:

VAR. SPEED FAN #01	
FUNCTION	
1 VAR. Fan 1	► YES
2 VAR. Fan 2	YES

- To enable a speed fan select **YES**.
- In *Installation > System Parameters*, enter the minimum fan speeds. Refer to **Min Motor1, 2, 3, 4 Spd**, page 28.

• Version 1.10 and above:

VAR. SPEED FAN #01				
Device	Func.	0%	100%	
1 VAR. Fan 1	YES	30	75	
2 VAR. Fan 2	YES	30	75	

- 30 / 75 are the default minimum and maximum values.
- To determine the minimum (0%) and maximum (100%) speeds, refer to TRIAC Calibration, page 51.

10.6 Sensor Definition

Select the temperature sensors 1-4 to use for each function using the Round Arrows key to apply and remove check marks. **You can view only those devices defined in the relay layout and variable heat.**

FUNCTION	1	2	3	4
Average	+	-	+	-
Tunnel +	-	-	-	
Heater 1	+	-	-	-
Heater 2	-	+	-	+
Heat Lamp 1	-	+	-	-
Heat Lamp 2	-	-	-	+
Curtain 1	+	+	-	-
Cool cell	-	-	-	-
Ex. System 1	-	-	-	-
Tun. Curt	-	-	-	+
Var. Heat 1	-	-	+	-

NOTE ***Average:** The average definition refers to the average temperature, according to the sensor defined. An empty line defined for a certain sensor, indicates that the sensor will operate according to the average temperature definition.*

10.7 Curtain Setup

CURTAIN SETUP #01		
CURTAIN	OPEN	CLS
Curtain1 ▶	60	60
Curtain2	60	60
Curtain3	60	60
Curtain4	60	60
Tunnel	60	60
Inlet	60	60

Curtain Setup tells the controller how fast your curtains and side inlets move. It needs this information to properly calculate automatic inlet advance as well as inlet and curtain positions.

10.8 Fan Air Capacity

In this screen set the fan air capacity for the, exhaust, tunnel, and variable speed fans.

Fan	M3/H	#01
Fan 1	30000	
Fan 2	30000	
Fan 3	30000	
Fan 4	30000	
Var.Fan 1	20000	
Var.Fan 2	20000	

- Default capacity: 30000 M3/H
 - Range: 0 - 99999
- Default capacity unit: M3/H
 - Variable: M3/H or CFM
- Default weight value: KG; Options: KG or LB
- Default temperature unit: Celsius; Options: Celsius or Fahrenheit

NOTE To select the capacity unit, weight value, and temperature unit refer to Farm Center setup, page 17.

1 1 Farm Master Plus

The following sections detail the Farm Master Plus functions.

- Cold Start
- Set Unit Number
- Main Menu
- Calibration
- TRIAC Calibration
- Test

11.1 Cold Start

To execute a cold start:

1. Disconnect the power.
2. Reconnect the power while pressing the three buttons of the Farm Master Plus together and hold them for about three seconds.

The following appears:



Cold Start erases all data and history from the memory and load factory defaults!!!

11.2 Set Unit Number

1. Press the two arrow keys simultaneously until NO blinks.
2. Set the unit number with the up and down arrows.
3. Press Select.

11.3 Main Menu

Once the **Farm Master Plus** is activated the main screen will appear showing the inside average temperature of the rooms. Pressing SELECT for 2 seconds allows the user through the main screen's information.

- **trg**: The target temperature for the room (can be changed from the Farm Master Plus itself, only if a curve was not defined.)
- **rH**: Humidity in room
- **rH.t**: Target humidity
- **day**: Growth day for the room

The display alternates between the name and the figure.

11.4 Calibration

Temperature sensors are very accurate and most likely will not require calibration. However, if calibration is required do the following:

11.4.1 Temperature sensor calibration

- Use an accurate thermometer reference.
- Place it near the temperature sensor.
- Make sure that the inside temperature is stable.
- Calibrate the temperature sensor immediately after reading.

11.4.2 Calibration procedure

1. Press **SELECT** and the “up” arrow keys simultaneously and hold them together for about two seconds. The display alternates between the sensor number and the temperature measured.
2. Use the arrow key to change the temperature.
3. Press **SELECT** to move through the sensors and the arrows to change temperatures.

NOTE Calibration of humidity sensor is done exactly the same way; the only difference is that instead of measuring temperature, the humidity is measured by an external humidity sensor.

11.5 TRIAC Calibration

The following procedure describes how to calibrate the Farm Center and Farm Master Plus 81/82 TRIAC functions.

- Install the Farm Center and Farm Master Plus units.
- Wire the variable fans to the Farm Master Plus units.
- The procedure requires a true-rms voltmeter (set to AC).
 1. Apply power to Farm Center and Farm Master Plus units.
 2. On the Farm Master, press **Select** and **Down** arrows until **tst** appears.
 3. Press **Select** repeatedly until **tr1** (TRIAC 1) or **tst2** (TRIAC 2) appears.
 4. Open the Farm Master Plus unit.
 5. Using the voltmeter, place the probes on \sim and **N** (Figure 4). The voltmeter displays the Farm Master voltage power input.

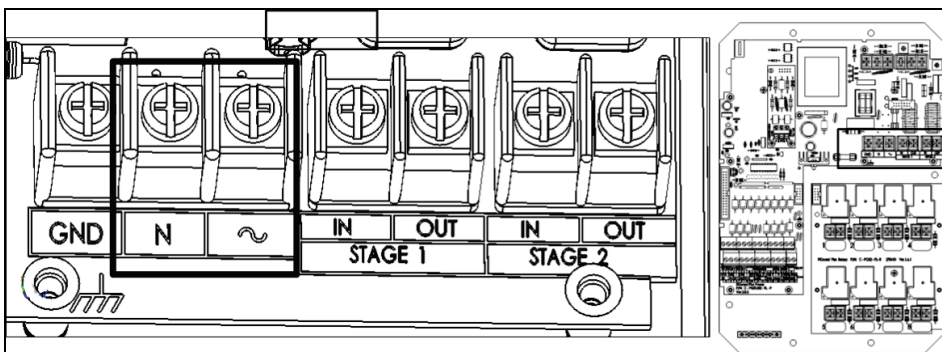

Figure 4: Input power ports

6. Note the voltage.

7. Place the probes on the **Input N** and **Stage Out** ports (Figure 5 or Figure 6 for TRIAC 1 or TRIAC 2 respectively). The voltmeter displays the voltage being provided to the fan.

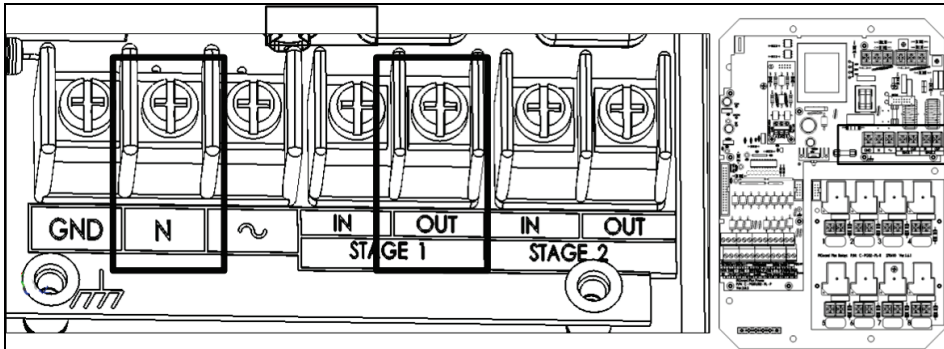

Figure 5: TRIAC 1 Power

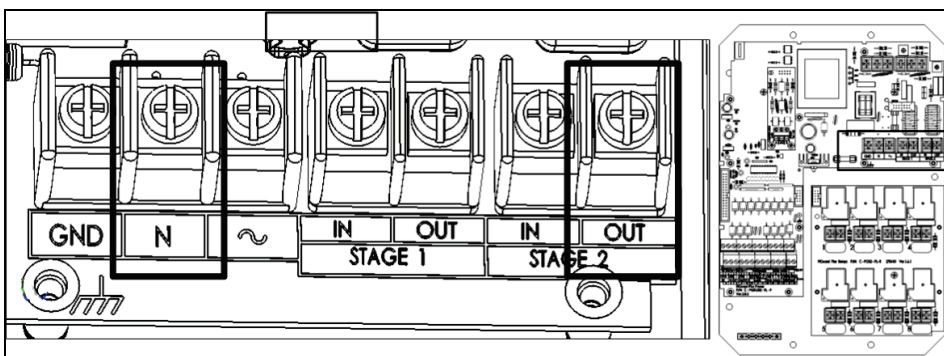

Figure 6: TRIAC 2 Power

8. Press the **Up** key. Farm Master displays 30. This is the default minimum voltage.
 - a. Continue pressing the **Up** key until the voltage displayed in the voltmeter equals the voltage displayed in Step 6 (if you continue to press the Up key, the voltage remains the same (or falls)). Click the **Down** key twice. Record the number displayed on the Farm Master screen.
 - b. Calibrating the TRIAC lower limit does not require a voltmeter. Press the down arrow until you reach the minimum required fan speed. Record the number displayed on the Farm Master screen.

CAUTION Munters recommends leaving the minimum level at the default definition (30).

9. In Farm Center, *Installation > Variable Speed Fan* (page 47), enter the numbers defined here under 0% and 100%.

10. Repeat for the second TRIAC (if required).

11.6 Test

The test option is used mostly in the installation process and it enables the installer to check systems.

To test a menu:

1. Press "SELECT" and "down" arrow keys simultaneously and hold them together for about two seconds. The display alternates between the name of the I/O and an ON/OFF sign.
2. Press the arrow keys to allow switching between On and Off.
 - rL.1-7: Relays 1 to 7
 - SPd: Variable speed (check minimum to full capacity using the arrow keys)
 - AO1-4: Analog outputs 1 to 4
 - t1, t2: Temperature sensors with the A/D counts blinking on the screen
 - Hu: Humidity sensor A/D counts
 - Ai1-2: Analog inputs 1 to 2
 - Prs: Pressure A/D counts
 - DG1-3: Digital inputs 1 to 3

12 Specifications

Power Supply	
Mains voltage single phase	115/230 VAC
Main fuse	315 mA
Secondary fuse	1 A
Maximum power consumption	22 VA
Available power for peripheral equipment	
Analog Inputs	
3 temperature sensors	RTS-2 (Thermistor)
4 analog outputs	20 mA, 0-10V
1 humidity sensor input	0-3V
2 analog inputs	0-5V
Digital Inputs	
3 digital inputs	Dry contact 5 V/ 2 mAmp
Relays Outputs	
8 N.O. power relays	2HP, 12 Amps, 250 Vac
Variable Speed Output	
2.2 Kw, 10 Amps, 230 Vac; HP 2.8 HP	
1.1 Kw, 10 Amps, 115 Vac; HP 1.4 HP	
Housing	
Dimensions (LxWxH cm)	92.5 x 73 x 36
Ambient climate	
Operating temperature range	0° to + 50° C
Storage temperature range	-10° to + 70° C
Indoor Applications	
The equipment is designed for use in indoor applications only!	
Certification	
	

13 Mechanical installation guide

WARNING! Only an authorized electrician can install the Farm Master Plus. Disconnect the power to avoid electrical shock and damage.

CAUTION Install the Farm Master Plus in the service room to avoid exposing the unit to harmful gases or high humidity.

- Installation Category (Over voltage Category) II
- The power supply to the controller should be protected by 10 Amps circuit breaker
- All electrical connections should comply with National Electrical code (NEC)

1. Screw the metal sheet on the back of the box using the 4 supplied screws. Mount the Farm Master through the mounting holes (see next page).
2. Open the enclosure lid by unfastening the four screws.
3. Drill holes at bottom of the box and place cable holders.
4. Place the required cables through the cable holders at the bottom of the unit. Connect the wires according to the wiring diagrams.
5. Make sure that you use wires large enough for the load of the variable speed.
6. To connect temperature and humidity sensors use shielded two or four conductor #18-#24 gauge cables. Connect the shields to the Ground metal strip. Do not connect the shields to more than one point, or you may induce ground loop currents.
7. Close the Farm Master enclosure lid carefully and tightly. Use RTV silicon or equivalent sealant to seal the cable holders.
8. After installation is completed, operate the Farm Master for a few hours and re- check for proper operation.

13.1 Environmental protection



Recycle raw materials instead of disposing as waste. The controller, accessories and packaging should be sorted for environmental-friendly recycling. The plastic components are labeled for categorized recycling.

13.2 Sensors and shielded wiring

- For long shielded wires, connect the shield to ground at **one end** only.
- From the ground terminal, run a heavy wire directly to the ground rod. It is acceptable, if necessary, to run the heavy ground wire to the electrical service grounding system rather than directly to the ground rod.
- Do not use light wires for these ground connections. They must carry heavy lightning currents, sometimes exceeding thousands of amperes. Certainly, do not use the shielding of sensor and low voltage wiring for this purpose.

- Ensure that all ground connections go to a single local point. When lightning strikes, grounds a meter or two apart will be at significantly different voltages. If you have several electronic boxes with individual grounds, connect all these together to a single point (If Possible), preferably to the surge protector ground. This should continue to the ground rod or the electrical service. In particular, avoid grounding any controls remotely through shield wiring.
- Do not use shields to create a path for lightning. For long shield wires, such as building to building runs, connect the shield to ground at *one end* only, to reduce the chance of conducting lightning from one building to another.
- When splicing sensors to longer wires, ensure that the splice is **waterproof**. Use adhesive lined heat shrink (marine grade) to make waterproof connections.
- Use a good compression connector for splicing. This is better than soldering. Do not simply twist wires together and then cover with electrical tape.
- Keep sensor wiring separate from other power distribution and high voltage wiring. Ensure that lightning on other wiring will not transfer to the sensors.
- Install outside temperature sensors so that the sun will not cause false readings, and so that exhaust air from the building will not affect the sensor.

13.3 Installation and electrical connections

- Install computerized electronic controls at least one meter (three feet) away from interference sources such as high voltage wiring to motors, variable speed, light dimmers, relays.
- Install electronic controls in a separate ventilated control room that is protected from extreme temperatures and dirty environments. Place the controls so that the operators can conveniently use the control and read indicators and displays.
- Give your installation a professional appearance, with all wiring in conduit or neatly installed. Keep low voltage wires separate from high voltage wires.
- Use shielded wiring for low level signals. For buried wiring (building to building runs) use high grade jell filled cables that are impervious to moisture.
- Seal cable entry points and control boxes to prevent contamination and corrosion. If you use silicon sealant with acetic acid cure, keep the control open and ventilated until cured. Otherwise, the acetic acid will attack the metal parts, including circuitry.
- Drill cable entry holes on the bottom of the box only.

13.4 Farm Center/Farm Master Plus wiring diagrams

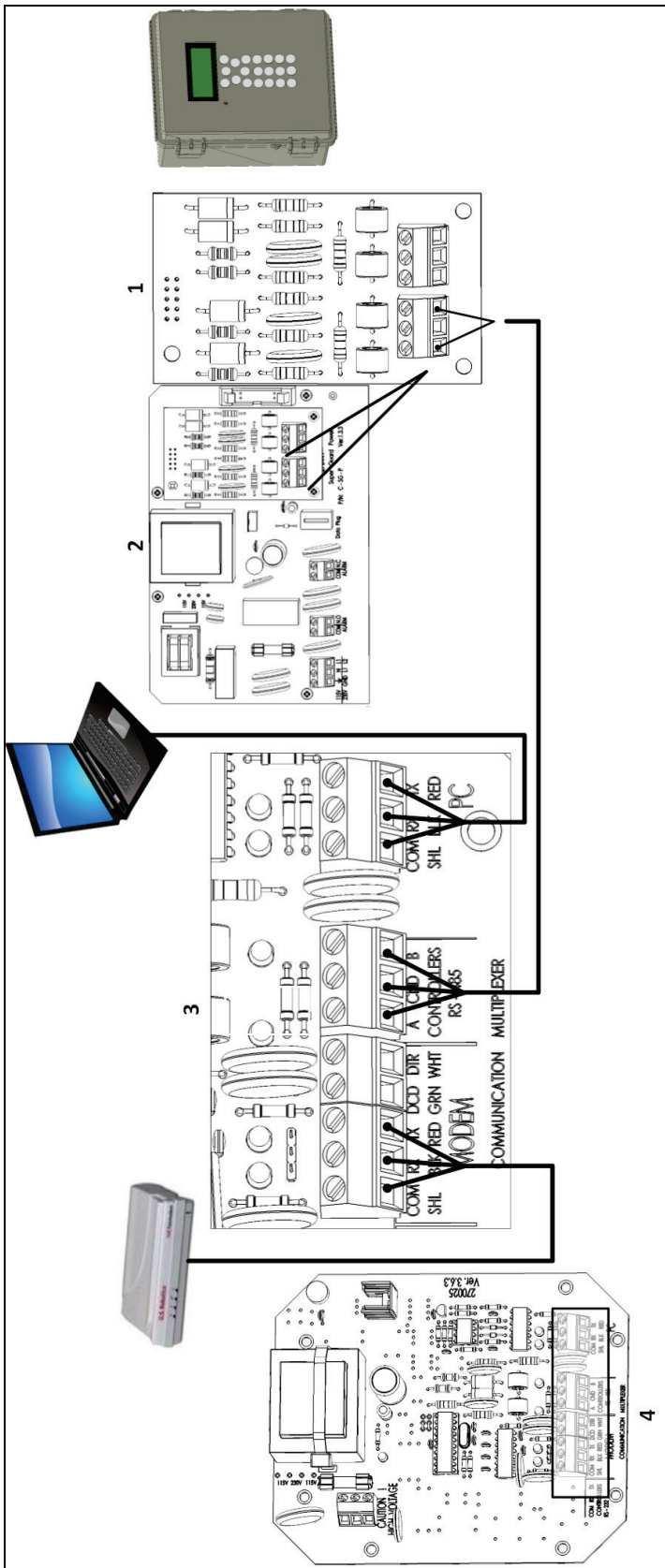

1	Farm Center communication card
2	Communication Box board
3	Communication ports RS 485 ports
4	MUX 485 Communication board

Figure 7: MUX – Farm Center Wiring Diagram

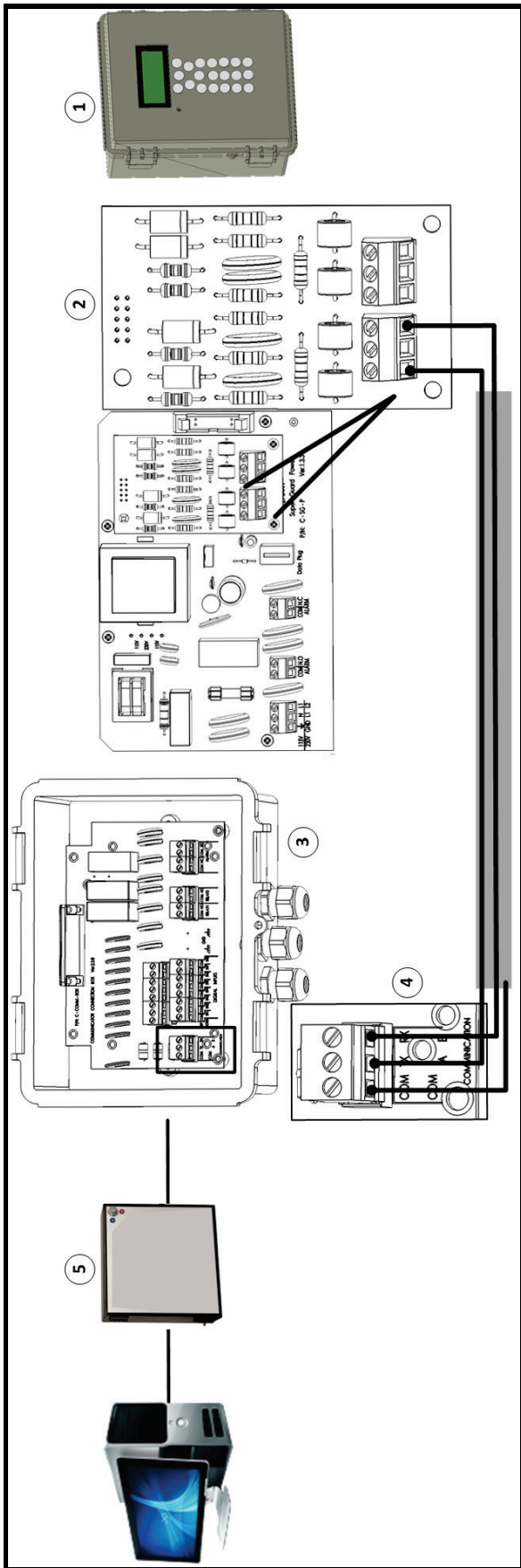

Figure 8 key	
1	Farm Center
2	Farm Center board
3	Farm Guard Communication Box
4	Communication ports
5	Farm Guard

Figure 8: Farm Guard Communication Box – Farm Center Wiring Diagram

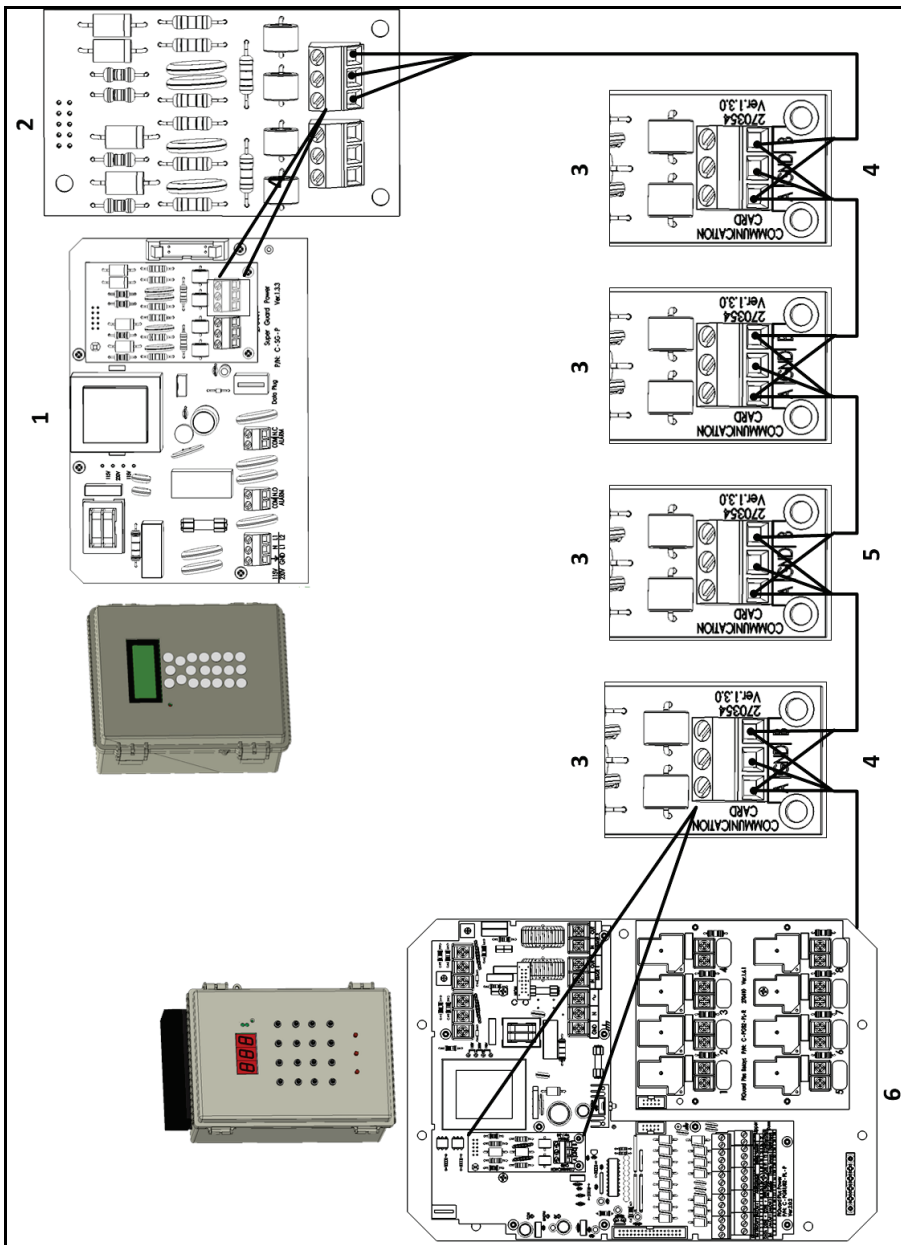

Figure 9: Farm Center – Farm Master Plus Wiring Diagram

Figure 9 key			
1	Farm Center board	4	Shield connected to this side
2	Farm Center communication card	5	Shield is connected to GND on one end of the cable only.
3	Farm Master Plus communication port	6	Farm Master board

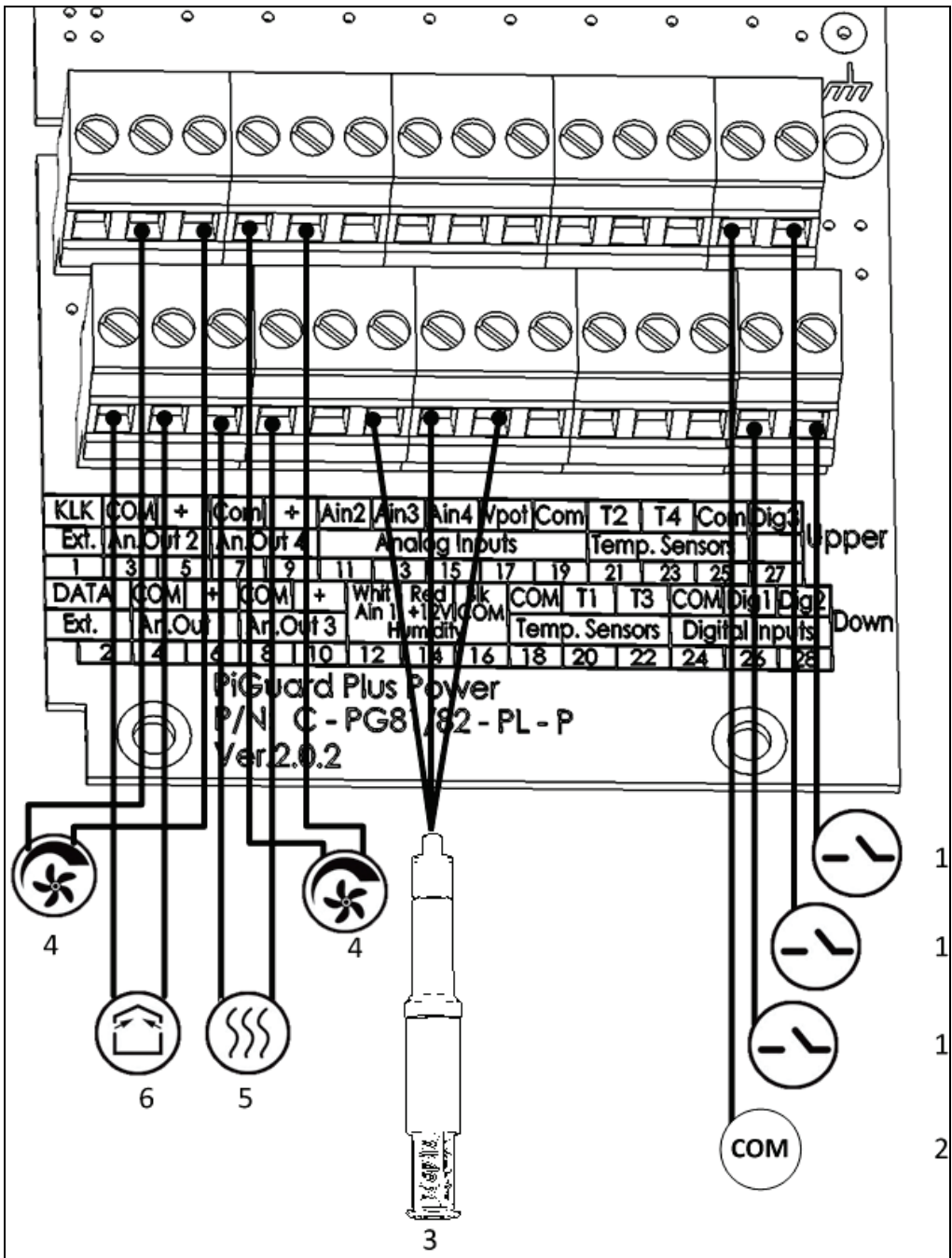

Figure 10: Farm Master Plus Wiring Diagram (Analog Output, Power, Variable Speed, RHS-2)

Figure 10 Key	
1	Digital input
2	COM
3	RHS-SE
4	Variable speed fan
5	Variable heater
6	Vents

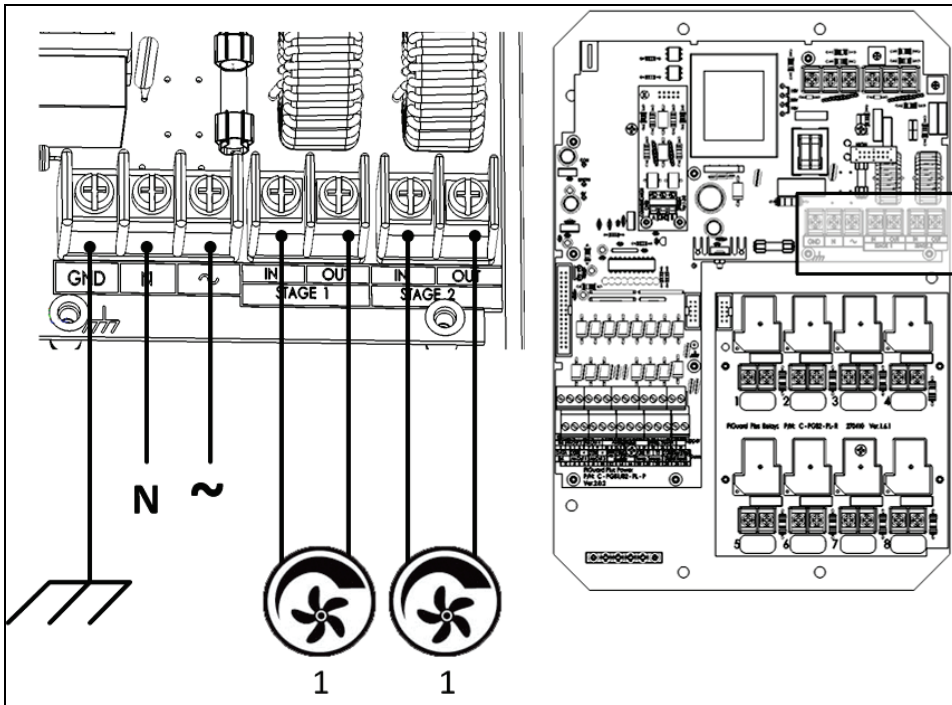

Figure 11: Farm Master Plus Wiring Diagram (Variable Speed)

1: Variable fans

The following table details the inputs.

		Number	Wire
Digital Input		25	COM
		26	Dig 1
		28	Dig 2
		27	Dig 3
Humidity		12	White
		14	Red
		16	Black
Analog output	1	4	COM
		6	+
	2	3	COM
		5	+
	3	8	COM
		10	+
	4	7	COM
		9	+

NOTE To ensure compliance with EMC 61000-6-3, install an appropriate filter; for example a TDK-RSHN-2016 L or similar device.

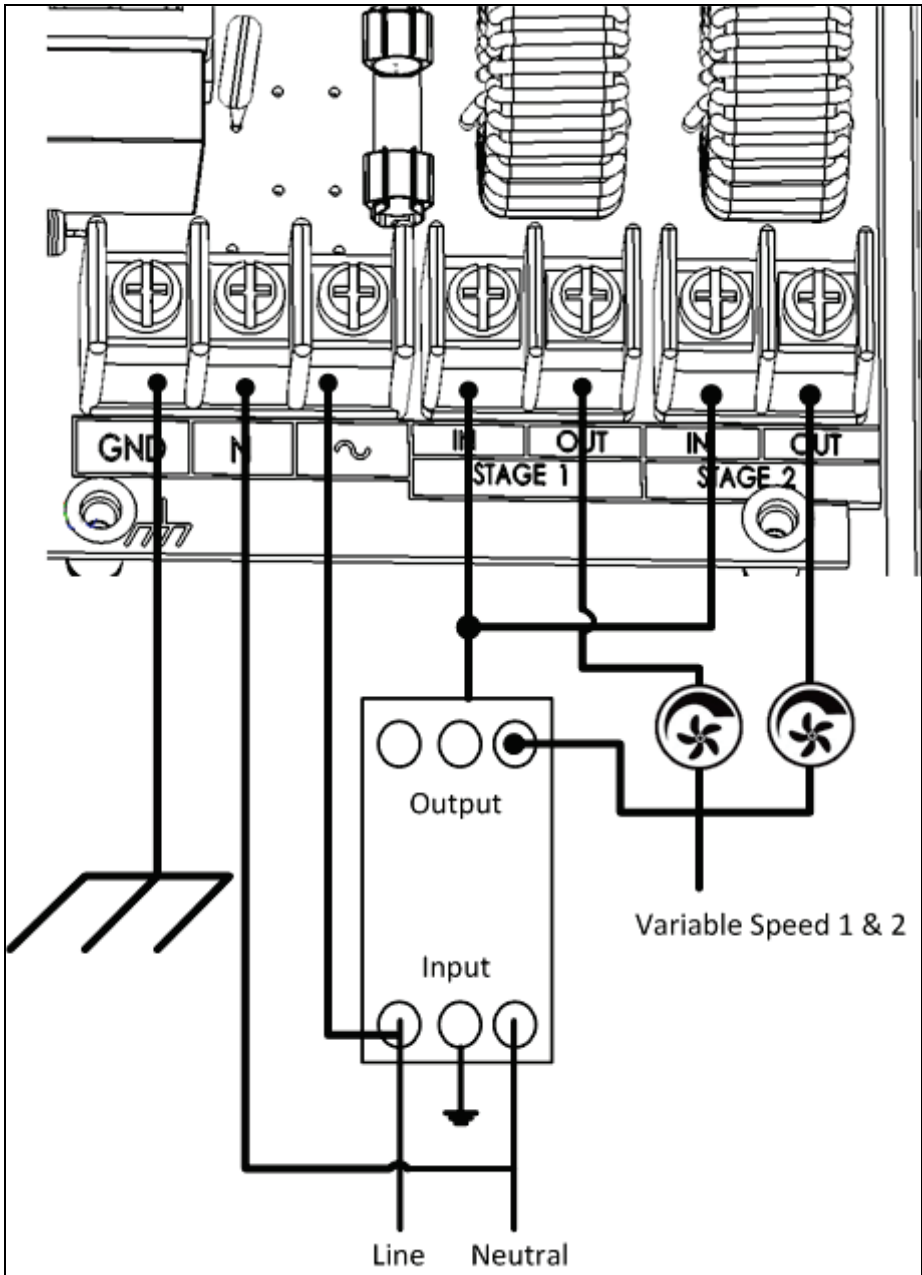

Figure 12: Wiring Diagram of Main Voltage Section Showing Filtering

NOTE All the remaining wiring to the main voltage section remains as illustrated above.

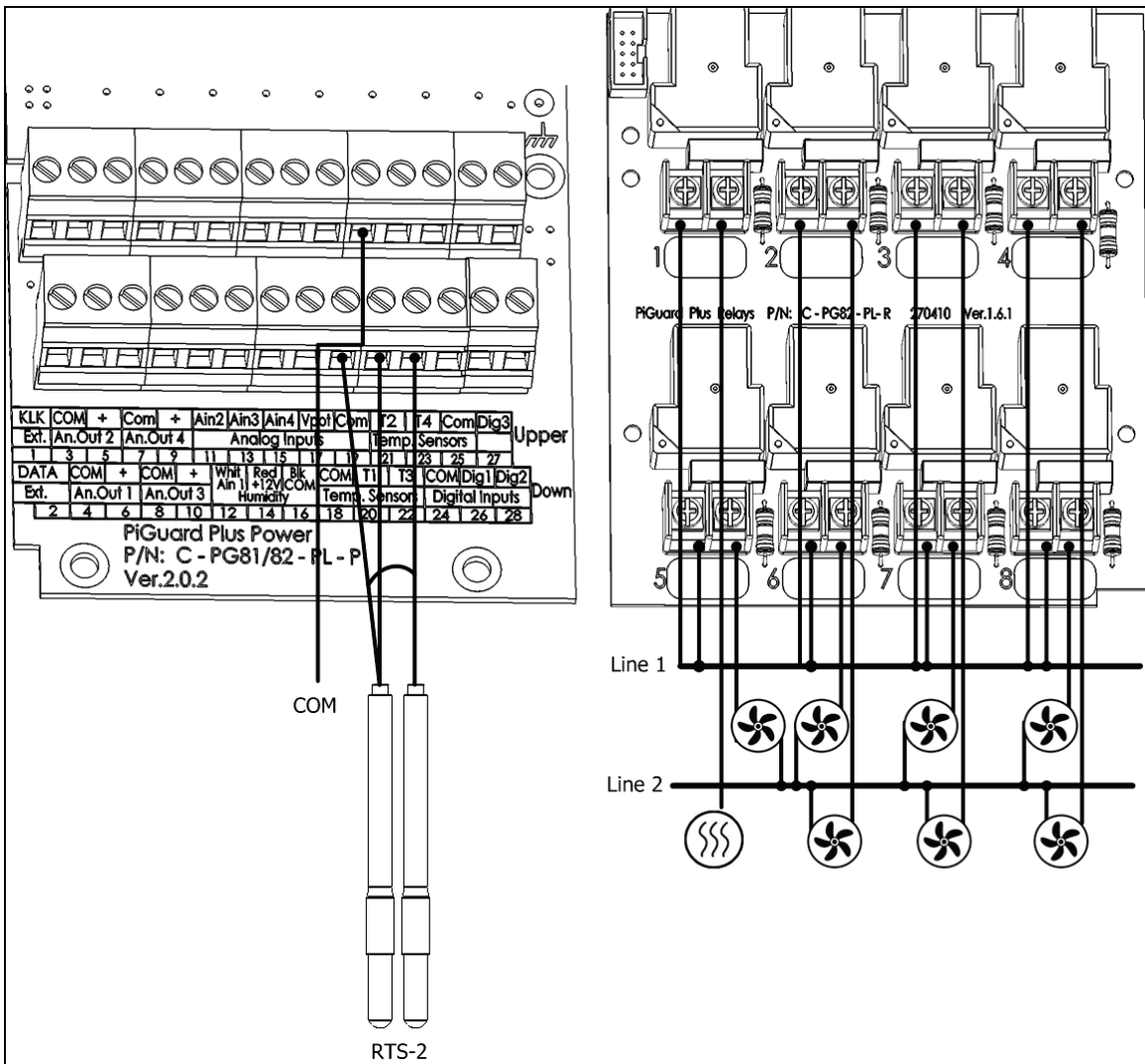

Figure 13: Farm Master Wiring Diagram (Relays, RTS-2)

	Number	Wire
Temperature sensor	18	COM
	20	T1
	21	T2
	22	T3
	23	T4

CAUTION Each output requires a 16 amp circuit breaker!

13.5 Dip Switch Configuration

On the Farm Master Plus' CPU are two parallel blue dip switches, located on the left hand side of the PCB. If you want hardware protection during curtains' activity, make sure you connect the curtains in pairs, according relay numbers (1, 2; 3, 4; 5, 6; etc.) and to move the three matching dipswitches to off position. On the PCB is written which switch goes with the relay. Not doing so may result in the motors closing and opening the curtains simultaneously, due to bad configuration or programming on behalf of the user.

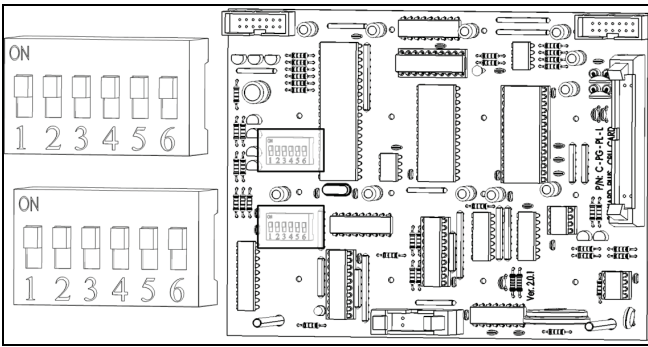

Figure 14: Farm Master Plus' CPU

13.6 Extension Box

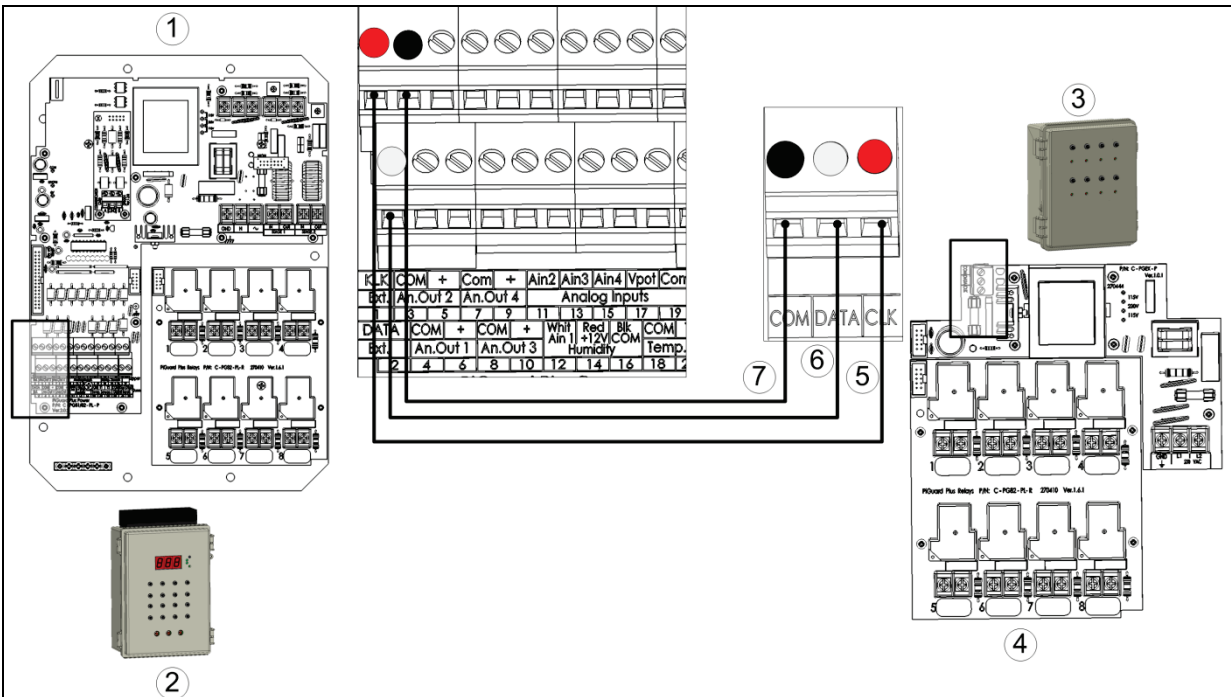

Figure 15: Farm Master Extension Box Wiring Diagram

Figure 15 Key			
1	Farm Master Plus board	5	Clock port
2	Farm Master Plus	6	Data port
3	Farm Master Plus Extension Box	7	COM port
4	Extension box board		

NOTE For detailed information regarding wiring a Farm Master Plus to the Farm Master Extension Unit, refer to the appropriate manual.

WARNING! Before wiring the Farm Master Plus to the Extension Box, disconnect the power on both units!

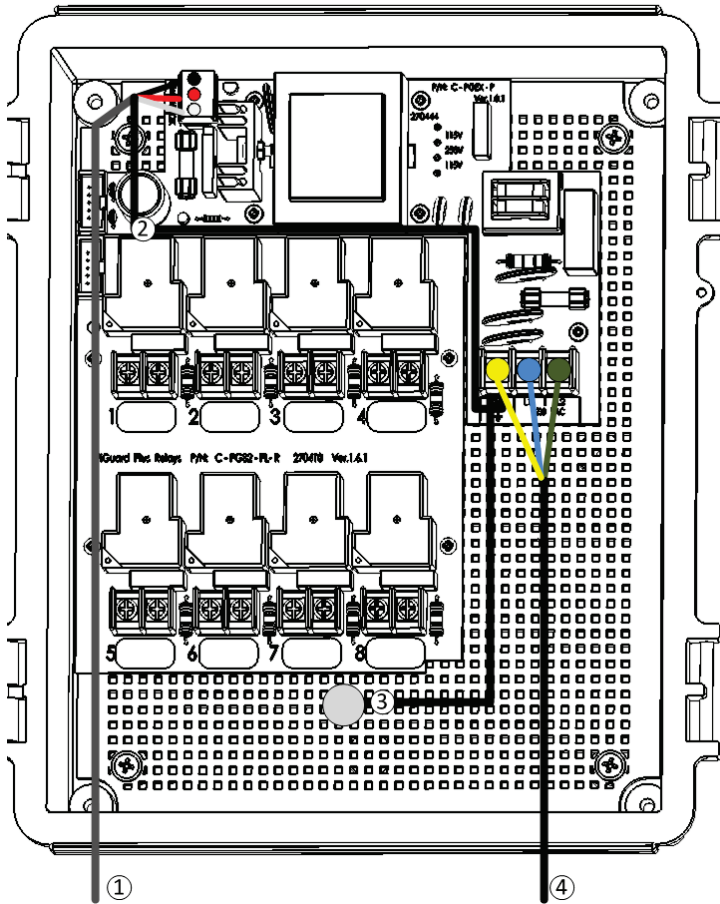

Figure 16 Key	
1	I2C cable
2	Ground wire connected to shield
3	Ground wire hole
4	Cable from Farm Master Plus
5	Variable heater
6	Vents

Figure 16: Farm Master Extension Box Wiring

- Before turning the Farm Master Plus on, make sure the Extension box is plugged in, so that the Farm Master Plus identifies the Extension box.
- The I2C communication cable (1 meter) is connected to the extension box and the shield is grounded. Don't extend the cable and distance it from high power cables.

The extension box should be connected with a shielded cable (I2C cable) as appears in Figure 16. The shield has to be connected to ground with a wire that is soldered to the shield of the I2C cable (factory supplied). The shield is connected to ground only on the extension box side (on the Farm Master side the shield has to be left unconnected).

14 Electrical Grounding

CAUTION Always connect temperature and sensor shields to earth ground.

Avoid mixing high voltage wiring with sensor and low voltage wiring.

Keep the controller as far as possible from heavy contactor boxes and other sources of electrical interference.

14.1 Ground Rods

Ground rods are used to efficiently connect the system to earth where current may be dissipated in the soil.

- Material: Ground rods should be copper clad or galvanized steel.
- Diameter: Minimum 5/8", preferably 3/4". Generally the larger the rod diameter, the lower it's resistance to current flow.
- Length: Minimum 2.5 meters (8 feet), preferably 3-meter (10-foot). A longer ground rod will reach a soil with higher moisture content. Moist soil carries current much better than drier soil.
- Single grounding: It is important that there is only one grounding location where a rod or series of rods are connected to each other using a ground wire.
- Independent ground rods will increase the risk of current, from a lightning strike for example, being dissipated through one rod and reentering the system through an adjacent rod.
- Location: Close to the main circuit breaker panel and in moist soil. For example in an area that is usually wet from a drip or a low spot where water drains. Make sure the area is well protected from damage by lawnmowers, tractors, etc'.
- Rod installation: Drive the rod into the earth until about 10 cm (4 inches) is left above grade. If it is impossible to drive the rod to the proper depth, it is acceptable to lay the rod horizontally, 80 cm (2.5 feet) below grade.

In case the rod is exposed to damage, for example by lawnmowers or tractors it can be installed in a hole, about 20 cm (8 inches) deep so that the rod is about 10 cm under grade and 10 cm above hole level.

CAUTION The National Electric Code (NEC) mandates two ground rods unless you can show less than 10 ohms resistance with one rod.

14.2 Ground Wire

The ground wire is a large copper wire that connects the main circuit breaker panel to the ground rod.

- Material: Ground rods should be copper clad or galvanized steel.
- Diameter: Typically, 16 mm (6-gauge) copper wire is sufficient. If the wire run is greater than 20 feet, 20 mm (4-gauge) wire should be used.
- Length: Minimum 2.5 meters (8 feet), preferably 3-meter (10-foot). A longer ground rod will reach a soil with higher moisture content. Moist soil carries current much better than drier soil.

The ground wire should be protected from damage by lawnmowers, tractors, etc'. It should be buried minimum 15 cm (6 inches) under grade for protection and enter the house as soon as possible. It is important that the wire not be cut; it should remain continuous.

14.3 Ground Clamps

Ground wires should not be merely wrapped around a ground rod. Ground clamps are used to attach a ground wire to a ground rod. The most common clamp is known as an acorn clamp. Make sure the ground clamps you select are rated for outdoor use. Do not use pipe clamps rated for inside water lines or hose clamps to attach the ground wire.

14.4 What Should Be Grounded?

Any equipment that is or could become energized, even accidentally, should be grounded. Current from lightning, strikes objects in a random fashion. Accounts of lightning strikes reveal scenarios most of us could not predict.

Electric circuits should be wired with a 3-wire conductor consisting of hot, neutral and grounding wires. The grounding wire should be attached cleanly and securely to devices or systems to be grounded. The other end of the grounding wire should be attached to the ground bus on the main panel.

14.5 Lightning Protection

Because of the potential for lightning damage to electronic devices, Rotem recommends supplying lightning protection on both the power supply and the communication terminals (if used).

14.5.1 Power Line Protection

The RPLP-1 provides lightning protection to controllers. Refer to the RPLP-1 documentation for detailed wiring instructions. While no lightning protection is perfect, the RPLP-1 significantly enhances the reliability of built-in lightning protection. In addition, Munters recommends using an isolation transformer in front of the RPLP-1 to help block lightning and other transients.

NOTE Common surge protectors provide little additional protection, and may trip unnecessarily.

An isolation transformer preceding the RPLP-1 provides significant additional protection against lightning.

14.5.2 Communication Line Protection

The RCLP-1 provides communication protection for the controller. Refer to the RCLP-1 documentation for detailed wiring instructions. Since outdoor communication lines can receive and conduct powerful electromagnetic pulses into the controllers and cause significant damage, Rotem advises using a RCLP-1 prevent damage to the units.

NOTE Common surge protectors provide little additional protection and may trip unnecessarily.

15 Warranty

Warranty and technical assistance

Munters products are designed and built to provide reliable and satisfactory performance but cannot be guaranteed free of faults; although they are reliable products they can develop unforeseeable defects and the user must take this into account and arrange adequate emergency or alarm systems if failure to operate could cause damage to the articles for which the Munters plant was required: if this is not done, the user is fully responsible for the damage which they could suffer.

Munters extends this limited warranty to the first purchaser and guarantees its products to be free from defects originating in manufacture or materials for one year from the date of delivery, provided that suitable transport, storage, installation and maintenance terms are complied with. The warranty does not apply if the products have been repaired without express authorization from Munters, or repaired in such a way that, in Munters' judgement, their performance and reliability have been impaired, or incorrectly installed, or subjected to improper use. The user accepts total responsibility for incorrect use of the products.

The warranty on products from outside suppliers fitted to Farm Center or Farm Master Plus, (for example sensors, cables, thermostats, etc.) is limited to the conditions stated by the supplier: all claims must be made in writing within eight days of the discovery of the defect and within 12 months of the delivery of the defective product. Munters has thirty days from the date of receipt in which to take action, and has the right to examine the product at the customer's premises or at its own plant (carriage cost to be borne by the customer).

Munters at its sole discretion has the option of replacing or repairing, free of charge, products which it considers defective, and will arrange for their dispatch back to the customer carriage paid. In the case of faulty parts of small commercial value which are widely available (such as bolts, etc.) for urgent dispatch, where the cost of carriage would exceed the value of the parts, Munters may authorize the customer exclusively to purchase the replacement parts locally; Munters will reimburse the value of the product at its cost price.

Munters will not be liable for costs incurred in demounting the defective part, or the time required to travel to site and the associated travel costs. No agent, employee or dealer is authorized to give any further guarantees or to accept any other liability on Munters' behalf in connection with other Munters products, except in writing with the signature of one of the Company's Managers.

WARNING: *In the interests of improving the quality of its products and services, Munters reserves the right at any time and without prior notice to alter the specifications in this manual.*

The liability of the manufacturer Munters ceases in the event of:

- dismantling the safety devices;
- use of unauthorized materials;

- inadequate maintenance;
- use of non-original spare parts and accessories.

Barring specific contractual terms, the following are directly at the user's expense:

- preparing installation sites;
- providing an electricity supply (including the protective equipotential bonding (PE) conductor, in accordance with CEI EN 60204-1, paragraph 8.2), for correctly connecting the equipment to the mains electricity supply;
- providing ancillary services appropriate to the requirements of the plant on the basis of the information supplied with regard to installation;
- tools and consumables required for fitting and installation;
- lubricants necessary for commissioning and maintenance.

It is mandatory to purchase and use only original spare parts or those recommended by the manufacturer.

Dismantling and assembly must be performed by qualified technicians and according to the manufacturer's instructions.

The use of non-original spare parts or incorrect assembly exonerates the manufacturer from all liability.

Requests for technical assistance and spare parts can be made directly to the nearest Munters office. A full list of contact details can be found on the back page of this manual.



www.munters.com

Australia Munters Pty Limited, Phone +61 2 8843 1594, **Brazil** Munters Brasil Industria e Comercio Ltda, Phone +55 41 3317 5050, **Canada** Munters Corporation Mason, Phone +1 517 676 7070, **China** Munters Air Treatment Equipment (Beijing) Co. Ltd, Phone +86 10 80 418 000, **Denmark** Munters A/S, Phone +45 9862 3311, **India** Munters India, Phone +91 20 3052 2520, **Indonesia** Munters, Phone +62 818 739 235, **Italy** Munters Italy S.p.A., Chiusavecchia, Phone +39 0183 52 11, **Japan** Munters K.K., Phone +81 3 5970 0021, **Korea** Munters Korea Co. Ltd., Phone +82 2 761 8701, **Mexico** Munters Mexico, Phone +52 818 262 54 00, **Singapore** Munters Pte Ltd., Phone +65 744 6828, **South Africa and Sub-Sahara Countries** Munters (Pty) Ltd., Phone +27 11 997 2000, **Spain** Munters Spain S.A., Phone +34 91 640 09 02, **Sweden** Munters AB, Phone +46 8 626 63 00, **Thailand** Munters Co. Ltd., Phone +66 2 642 2670, **Turkey** Munters Form Endüstri Sistemleri A.Ş, Phone +90 262 751 37 50, **USA** Munters Corporation Mason, Phone +1 517 676 7070, **Vietnam** Munters Vietnam, Phone +84 8 3825 6838, **Export & Other countries** Munters Italy S.p.A., Chiusavecchia Phone +39 0183 52 11