

# Manual for use and maintenance

AC-2000  
3G



## AC-2000 3G

Climate Controller

# AC-2000 3G

## Manual for use and maintenance

**Revision:** N.2.5 of 03/2019

Ag/MIS/UmEn-2612-07/18 Rev 1.2

**Product Software:** 9.19

This manual for use and maintenance is an integral part of the apparatus together with the attached technical documentation.

This document is destined for the user of the apparatus: it may not be reproduced in whole or in part, committed to computer memory as a file or delivered to third parties without the prior authorization of the assembler of the system.

Munters reserves the right to effect modifications to the apparatus in accordance with technical and legal developments.

# Index

<i>Chapter</i>		<i>page</i>
<b>1</b>	<b>INTRODUCTION</b>	<b>3</b>
1.1	Disclaimer	3
1.2	Introduction	3
1.3	Notes	3
<b>2</b>	<b>INTRODUCTION TO THE AC-2000 3G</b>	<b>4</b>
2.1	Keypad	4
2.2	Hot Screens	5
2.3	Standard Display	6
2.4	Main Menu Icons	7
2.5	Cold Start	8
<b>3</b>	<b>CONTROL MENU</b>	<b>9</b>
3.1	Temperature Curve	9
3.1.1	Temperature Curve Help   Set Definitions	10
3.1.2	Radiant Heaters Help   Set Definitions	11
3.1.3	Cycle Heaters   Set Definitions	12
3.1.4	Variable Heater Help   Set Definitions	13
3.1.5	Variable Floor Heater   Set Definitions	16
3.2	Introduction to Humidity, Ammonia, and CO2 Treatment	17
3.3	Humidity Treatment	17
3.3.1	Humidity Treatment Help   Set Definitions	18
3.4	CO2 Treatment	19
3.4.1	CO2 Treatment Help   Set Definitions	20
3.5	Min/Max Level	20
3.5.1	By Day and By Soft Days Curve	21
3.5.2	By Time	21
3.5.3	Day Soft Min.	22
3.5.4	By Weight	22
3.6	Static Pressure	27
3.6.1	Disabling the Static Pressure Sensor	27
3.6.2	Static Pressure Help   Set Definitions	28
3.6.3	Multi Stage Tunnel Curtains	28
3.7	Control Mode	29
3.8	System Parameters	29

3.9	Ammonia Treatment	30
3.9.1	Ammonia Treatment Help   Set Definitions	31
<b>4</b>	<b>DEVICE MENU</b>	<b>32</b>
4.1	Levels of Ventilation	33
4.1.1	Levels of Ventilation Help   Set Definitions	34
4.1.2	Wind Chill	34
4.2	Variable Speed Fan Levels	35
4.3	Vent & Curtain Levels	36
4.3.1	Vent & Curtain Levels Help   Set Definitions	37
4.4	Stir Fan Levels	37
4.5	Stir Fan Program	38
4.5.1	Stir Fan Program Help   Set Definitions	39
4.6	Cool Pad	40
4.6.1	Cool Pad Help   Set Definitions	41
4.7	Foggers	42
4.7.1	Foggers Help   Set Definitions	42
4.8	Light	43
4.8.1	Light Help   Set Definitions	44
4.9	Water & Feed	45
4.9.1	Water and Feed Help   Set Definitions	46
4.10	Extra Systems	47
4.11	Water on Demand	48
4.11.1	Relay Control	48
4.11.2	Sensor Control	48
<b>5</b>	<b>MANAGE MENU</b>	<b>50</b>
5.1	Inventory	50
5.2	Feed Inventory	51
5.2.1	Feed Inventory Help   Set Definitions	51
5.3	Time & Date	51
5.4	Growth Day & Flock	52
5.5	Alarm Setting	52
5.5.1	Alarm Setting Help   Set Definitions	54
5.6	Alarm Reset	56
5.7	Password	56
<b>6</b>	<b>SCALE MENU</b>	<b>57</b>
6.1	Scale Layout	57
6.2	General Settings	57
6.2.1	General Settings Help   Set Definitions	58
6.3	Bird Scale Setting	58

6.3.1	Bird Scale Setting, Version 9.18 and Below .....	58
6.3.2	Bird Scale Setting, Version 9.19 .....	59
6.4	Bird Curve/Bird Weight.....	59
6.4.1	Bird Curve, Version 9.18 and Below .....	60
6.4.2	Bird Weight, Version 9.19 .....	60
6.5	History.....	61
6.5.1	History, Version 9.18 and Below.....	61
6.5.2	History, Version 9.19 .....	62
6.6	Feed Conversion.....	63
6.7	Test.....	63
6.8	Calibration.....	63
<b>7</b>	<b>HISTORY MENU.....</b>	<b>65</b>
7.1	Temperature.....	65
7.2	Humidity.....	65
7.3	CO2.....	65
7.4	Water.....	66
7.5	Feed.....	66
7.6	Mortality.....	66
7.7	Heaters.....	66
7.8	Radiant Heaters.....	67
7.9	Alarms.....	67
7.10	Table of Events.....	67
7.11	History View.....	67
<b>8</b>	<b>TEST MENU.....</b>	<b>68</b>
8.1	Relays.....	68
8.2	Alarm.....	68
8.3	Analog Sensors.....	69
8.4	Digital Sensors.....	69
8.5	Analog Output.....	69
8.6	Static Pressure.....	70
8.7	Communication.....	70
<b>9</b>	<b>SERVICE MENU.....</b>	<b>71</b>
9.1	Temperature Calibration.....	71
9.2	Humidity Calibration.....	72
9.3	CO2 Sensor Calibration.....	72
9.4	Static Pressure Calibration.....	73
9.5	Light Sensor Calibration.....	74
9.6	Feed Calibration.....	74
9.7	Water Calibration.....	75

9.8	Ventilation Potentiometer Calibration	75
9.9	Save Settings to SD Card	76
9.10	Read from SD Card	77
9.10.1	Load Settings Report	77
9.11	WOD Calibration	78
9.11.1	WOD Calibration Help   Set Definitions	78
<b>10</b>	<b>INSTALL MENU</b>	<b>79</b>
10.1	Setup	79
10.1.1	Static Pressure Unit Definition	80
10.2	Relay Layout	80
10.2.1	Supported Relays	80
10.2.2	Relay Layout - Help   Set Definitions	81
10.3	Analog Sensors	81
10.4	Digital Sensors	82
10.5	Analog Output	83
10.6	Vent/Curtain Setup	83
10.6.1	Using Time to Calibrate	83
10.6.2	Using a Potentiometer to Calibrate	84
10.6.3	Vent/Curtain Help   Set Definitions	84
10.7	Temperature Definition	85
10.8	Fan Air Capacity	86
10.9	House Dimensions	86
10.10	Communication	86
<b>11</b>	<b>TECHNICAL SPECIFICATIONS</b>	<b>88</b>
<b>12</b>	<b>INSTALLATION</b>	<b>89</b>
12.1	Precautions	89
12.1.1	Grounding	89
12.1.2	Filtering	89
12.1.3	Checking the Battery Level	89
12.1.4	Frequency Inverters	89
12.2	Mounting the Unit	90
12.3	AC-2000 3G Wiring	91
12.3.1	Board Layout	91
12.3.2	Relays	92
12.3.3	High Voltage Wiring (Relays)	93
12.3.4	Terminal Setup	94
12.4	Communication Card	98
12.4.1	Wiring	99
12.4.2	Communication Card Grounding	101

12.4.3	Termination and 5V Setup.....	101
<b>13</b>	<b>APPENDIX A: DATA OUTPUT</b> .....	<b>104</b>
<b>14</b>	<b>APPENDIX B: INSTALLING A CO2 SENSOR AND SECOND HUMIDITY SENSOR</b> .....	<b>107</b>
14.1	Humidity Sensor.....	108
14.2	CO2 Sensor.....	108
<b>15</b>	<b>APPENDIX C: AC-2000 3G PANEL MOUNT</b> .....	<b>110</b>
15.1	Metal Assembly Precautions.....	110
15.2	Panels.....	110
15.3	Panel Dimensions.....	111
15.4	Connecting the Metal Panels.....	111
15.4.1	Precautions.....	111
15.4.2	Panel Mount Cable Connections.....	112
<b>16</b>	<b>APPENDIX D: ELECTRICAL GROUNDING FOR CONTROLLERS</b> .....	<b>113</b>
16.1	Ground Rods.....	113
16.2	Ground Wire.....	114
16.3	Ground Clamps.....	114
16.4	What Should Be Grounded?.....	114
<b>17</b>	<b>WARRANTY</b> .....	<b>115</b>

# 1 Introduction

## 1.1 Disclaimer

Munters reserves the right to make alterations to specifications, quantities, dimensions etc. for production or other reasons, subsequent to publication. The information contained herein has been prepared by qualified experts within Munters. While we believe the information is accurate and complete, we make no warranty or representation for any particular purposes. The information is offered in good faith and with the understanding that any use of the units or accessories in breach of the directions and warnings in this document is at the sole discretion and risk of the user.

## 1.2 Introduction

Congratulations on your excellent choice of purchasing an AC-2000 3G!

In order to realize the full benefit from this product it is important that it is installed, commissioned and operated correctly. Before installation or using the fan, this manual should be studied carefully. It is also recommended that it is kept safely for future reference. The manual is intended as a reference for installation, commissioning and day-to-day operation of the Munters Controllers.

## 1.3 Notes

Date of release: July 2010

Munters cannot guarantee to inform users about the changes or to distribute new manuals to them.

All rights reserved. No part of this manual may be reproduced in any manner whatsoever without the expressed written permission of Munters. The contents of this manual are subject to change without notice.



# 2 Introduction to the AC-2000 3G

This document describes the **AC-2000 3G** Precision Mode operation.

Computerized Electronic Controllers such as the AC-2000 3G advance the producer's ability to grow high quality eggs by accurately controlling the environment. Instead of struggling with individual thermostats for heat zones and ventilation, AC-2000 3G brings them all together into one convenient place with great accuracy. The AC-2000 3G optimizes and precisely applies your equipment and energy sources to most benefit from the accuracy of your computer and sensors.

The AC-2000 3G coordinates your ventilation equipment in precise levels of ventilation to provide the optimal fresh air balanced with heating costs. The light and feed clocks provide additional channels for greater capability. Besides advanced Cooling Pad methods, you benefit from superior stir fan programs to recover ceiling heat and other features. Precision Mode's additional features enable you to improve your profitability significantly.

AC-2000 3G provides a variety of management and history utilities. You can choose from simple overviews, or fully detailed *by the minute* records of minimum, maximum and average temperatures for each individual sensor. The unique **Table of Events** records the moment of every significant action taken by the AC-2000 3G and, optionally, its operator.

- Keypad, page 4
- Hot Screens, page 5
- Standard Display, page 6
- Main Menu Icons, page 7

## 2.1 Keypad

The diagram illustrates the keypad controls and their functions:

- Enter main menu, also acts as "ESC" or "Back" key
- Access help screens and graphs
- Erase typing mistakes
- Enter menus, values, open windows
- Scroll up, down, left and right

The keypad layout includes a numeric keypad (1-9, 0, +/-, .), a directional pad (up, down, left, right arrows), and a set of function keys (Menu, Info, Erase, Enter).

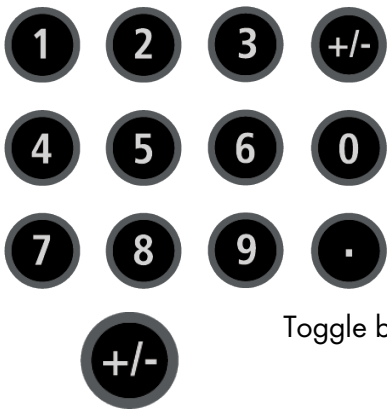

Enter values, select options and make selections

Toggle between positive and negative values and mark check boxes.

## 2.2 Hot Screens

Many of the keys serve as shortcuts. Here are the main ones:



Software version



Return to standard main screen



Temperature, Humidity Status, and Wind Chill Temperature

*NOTE If two humidity sensors are installed, Hot Screen 2 displays their average.*



Curve status



Curtain tunnel, vent, and attic opening positions



Bird scale status



Light status



Analog output status



Temperature sensors



Feed bin status



Scan through Hot Screens for five seconds each



Air Status (refer to Weight Hot Screen, page 26 for details on this screen)



Stir fans status



Increase/ decrease offset from temperature setting from the standard display only (hold both keys) - defined in the [TEMPERATURE CURVE HELP | SET](#)



## 2.3 Standard Display

The main screen consists of the following parts.

SENSORS		AV. TEMP.	ACTIVE	
Temp1	37.9°	27.5°	Heat	1
Temp2	16.2°		Heat. Hi	1
Temp3	28.2°		Tun. Fan	
E. Tmp1	28.8°		Exh. Fan	
E. Tmp2	28.4°		Stir	
Press.	23		Cool P.	
Out T.	23.9°		Fogger	
Hum. In	58.7%		Curt. 1	100%
Hum. Out	61.9%		Curt. 2	100%
Weight	0.000		Curt. 3	0%
Weights	0		Curt. 4	0%
			Ext. Sys	
			Alarm	
<b>4 MESSAGES</b>				
(2) Low Feed At Bin 2				

1. **Sensors:** Displays individual sensor readings. Temperature sensors marked with dark squares form the current average temperature.

- **Filled square:** Indicates the sensor participates in the average calculation.
- **Empty square:** Indicates the sensor does not participate in the average calculation.

SENSORS	
Temp1	37.9°
Temp2	16.2°
Temp3	28.2°
E. Tmp1	28.8°
E. Tmp2	28.4°
Press.	23
Out T.	23.9°
Hum. In	58.7%
Hum. Out	61.9%
Weight	0.000
Weights	0

Go to Table 1: Sensor Readings page 104, to view all the possible sensors.

2. **Av. Temp:** Reports the current average temperature. This example is in Celsius, but yours may be in Fahrenheit.

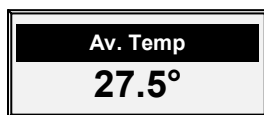

3. **Active:** Displays the output relay list. The filled black boxes indicate active outputs. Controller also informs the position of inlets and curtains, as well as the number of operating heaters or fans.

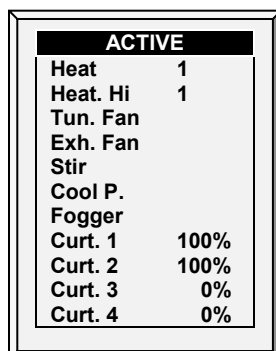

Go to Table 2: Output List (Active), page 104 to view all the available readings (ACTIVE).

The ACTIVE screen shows rectangular markers by the outputs. Filled rectangles indicate operating outputs; empty rectangles indicate outputs that are off.

4. **Status:** Provides important general information such as the time and ventilation mode.

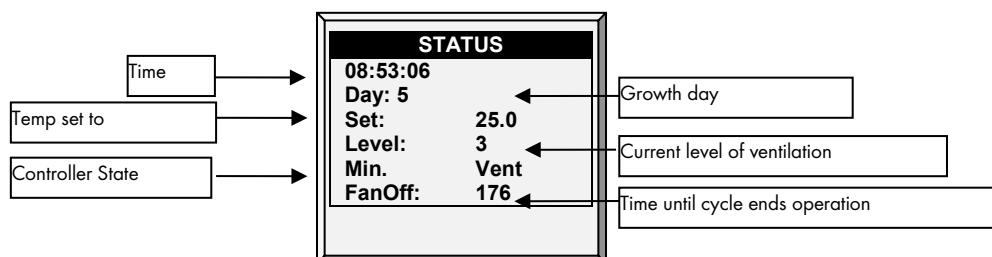

Go to Table 1: Sensor Readings, page 104 to view all the available readings.

5. **Messages:** Displays important messages/alarms. The title bar displays the number of important messages, and if there are several messages, they each appear in turn.

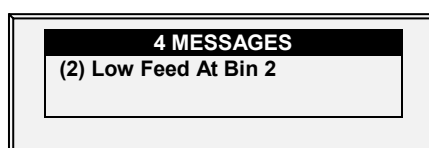

## 2.4 Main Menu Icons

1. To enter the Main Menu screen, press **Menu**.
2. To select an option, press **Enter**.

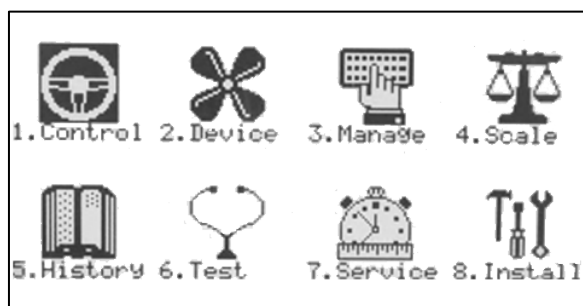

1. Control temperature, humidity, ventilation, static pressure and system parameters.

2. Define equipment settings
3. Manage inventory, livestock, and alarm/password settings.
4. Set, calibrate and test bird scales.
5. View history of all controller functions.
6. Test to see switches, relays, communication, and alarms are functioning properly.
7. Calibrate temperature, humidity, ventilation, static pressure, feed, water, read/save to plug.
8. Install sensors, devices, communication, etc.

## 2.5 Cold Start

### To perform a cold start:

1. Disconnect the power cable from the power source.
2. Reapply power while pressing **Delete**. The Cold Start screen appears.
3. Select **Yes**.

# 3 Control menu

The following sections detail the following functions:

- Temperature Curve, page 9
- Introduction to Humidity, Ammonia, and CO2 Treatment, page 17
- CO2 Treatment, page 19
- Min/Max Level, page 20
- Static Pressure, page 27
- Control Mode, page 28
- System Parameters, page 29
- Ammonia Treatment, page 30

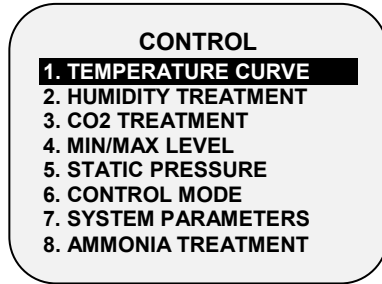

## 3.1 Temperature Curve

This screen sets the temperature targets according to the bird age.

TEMPERATURE CURVE						
Day	Target	Heat	Tunnel	Alarm		T.Hi
				Low	High	
1	89.0	89.0	100.0	84.0	102.0	103
2	89.0	89.0	99.0	84.0	102.0	103
3	87.0	87.0	97.0	82.0	95.0	103
7	84.0	83.0	91.0	80.0	95.0	103
15	82.0	81.0	89.0	78.0	93.0	103
21	79.0	78.0	86.0	75.0	90.0	103
28	76.0	74.0	81.0	71.0	87.0	103
35	72.0	70.0	77.0	67.0	84.0	103
42	70.0	68.0	75.0	63.0	83.0	103
48	68.0	66.0	73.0	60.0	83.0	103

1. In *Install > Analog Sensors* (refer to Analog Sensors, page 81), designate the required number of sensors as temperature sensors. When using more than one sensor, AC-2000 3G begins treatments based on the average.
2. In *Install > Relays Layout*, define the required number of relays as Heaters.
3. If required, go to *Service > Temperature Calibration*, calibrate the sensors.
4. In *Install > Temperature Definition*, assign specific sensors brood setups, heater zones, and devices. If a zone does not have an assigned sensors, calculations are based on the current average temperature.
5. In *Control > Temperature Curve*, define the required target temperature curve
  - Set up to 20 lines, 999 growth days. When a curve is not required, enter temperatures in the first line only.
    - Define: **Day**: Sets growth day. You can program negative growth days up to -7 for pre-warming. To enter a negative growth day, type the day number followed by the +/- key.

- **Target:** Set the desired temperature.
- **Heat:** Set the temperature to stop heat.
- **Tunnel:** Set the temperature for tunnel ventilation to begin.
- **Alarm Low & High:** Set average temperature alarm limits. See [Manage | Alarm Settings](#) for zone alarm settings.

6. In *Manage > Alarm Setting*, set the Sensor Alarms (page 52).

7. If required set the:

- Temperature Curve Help | Set Definitions, page 10
- Radiant Heaters Help | Set Definitions, page 11
- Cycle Heaters | Set Definitions, page 12
- Variable Heater Help | Set Definitions, page 13
- Variable Floor Heater | Set Definitions, page 16

### 3.1.1 TEMPERATURE CURVE HELP | SET DEFINITIONS

- ② While viewing the Temperature Curve menu: Press **HELP**, select *SET*, and press *ENTER*.

SYSTEM PARAMETERS	
<b>TEMPERATURE CURVE</b>	
Temperature Curve Offset	0.0
Set Temp. Change Reminder (Diff)	3.0
Target Temp. Band	1.5
Heater Temp. Band	1.0
Cool Down Factor (%)	15
Cool Down Fast Response (Deg.)	3.0
Min Vent Below Heat Temp By: ▶	ZONE
Non Brood Area Diff. From Heat	-3.0

- **Temperature Curve Offset:** Adjusts all temperature curves by this amount. You can use this to temporarily adjust all temperatures up or down for special circumstances. The curve appears in the [Status Window](#), and you can use the [ENTER and Up](#) or [ENTER and Down](#) hot key combinations to change the offset.
- **Set Temperature Change Reminder (Diff):** Sets the change in set temperature that triggers a reminder for you to set backup thermostats. Often producers forget to set backup thermostats as their birds grow from baby chicks to market age, so the AC-2000 3G reminds you. When you press Enter to acknowledge the reminder, the AC-2000 3G logs it in the Table of Events.
- **Target Temperature Band:** The size of the target temperature zone. This "Happy Zone" is between Target Temperature and (Target Temperature + Band).
- **Heater Temperature Band:** Heaters turn on at 'Band' degrees below Heat, and turn off at the Heat Temperature.

*NOTE Heaters operate at minimum level only; however, Radiant Heaters can operate at any temperature or level below Tunnel.*

- **Cool Down Factor (%):** Minimum percentage correction towards target during each increase [ventilation level delay](#). If average temperature does not improve by this amount, the AC-2000 3G increases ventilation by one level.
- **Cool Down Fast Response (Deg.):** Set a limit to the maximum degrees per minute of cooling. If Average Temperature drops more than this in one minute, the AC-2000 3G decreases ventilation one level to avoid overshooting.

*NOTE Avoid making this parameter too small or the normal temperature variation caused by timer fans reduces the ventilation level.*

- **Min Vent Below Heat Temp By:** Tells controller to go directly to Min Level in some cases. Select from the following choices:
  - None: Operate by the normal level decrease time delay rule.
  - Zone: Go directly to minimum level if any active temperature sensor reaches heat temperature.
  - Avg.: Go directly to minimum level if the average temperature reaches heat temperature.
- **Non Brood Area Diff. From Heat:** Set differential temperature for non-brood heaters. You normally use this to set temperatures in unoccupied areas.

*NOTE When set at -99° F the heaters are effectively disabled, since it will probably never go to 99° F below the heater temperature. Putting this parameter at 0° sets the non-brood areas to the heater temperature.*

### 3.1.2 RADIANT HEATERS HELP | SET DEFINITIONS

SYSTEM PARAMETERS	
<b>TEMPERATURE CURVE</b>	
Temperature Curve Offset	0.0
Set Temp. Change Reminder (Diff)	3.0
Target Temp. Band	1.5
Heater Temp. Band	1.0
Cool Down Factor (%)	15
Cool Down Fast Response (Deg.)	3.0
Min Vent Below Heat Temp By:	ZONE
Non Brood Area Diff. From Heat	-3.0
<b>RADIANT HEATERS</b>	
Rad. Low -Diff from Heat Set	0.0
Rad. High -Diff (Below Low Set)	1.0
Radiant Ignition Time (sec)	30

To configure the radiant heaters:

1. In *Installation > Relay Layout* define at least one relay as a radiant heater (Relay Layout, page 80).
2. Configure the following parameters:
  - **Radiant Low - Differential from Heat Set:** Set degree of difference from Heat for LOW Radiant Heaters to begin working. This differential can be positive or negative. (default: 2.0)
  - **Radiant High - Differential (Below Low Set):** Set number of degrees below Radiant Low Heaters for HIGH Radiant Heaters to begin working (default: 1.0). To ensure proper heater ignition, Radiant High Heaters remain on for the Radiant Ignition Time along with the Radiant Low Heaters.
  - **Radiant Ignition Time (sec):** Set number of seconds to power radiant ignition (default: 30).

The Heater Temperature Band applies to radiant heaters as well. For example, if the Heat Temperature is 80° F and the Heater Temperature Band is 1° F, heaters turn on at 79° F and off at 80° F. If the Radiant Low Differential is 2.0° F, radiant heaters turn off at 82° F, and on 1° F below that (81° F). However, a Radiant High Heater turns on regardless of its temperature setting for the Radiant Ignition Time whenever the corresponding Radiant Low Heater turns on. This feature ensures proper flame ignition.



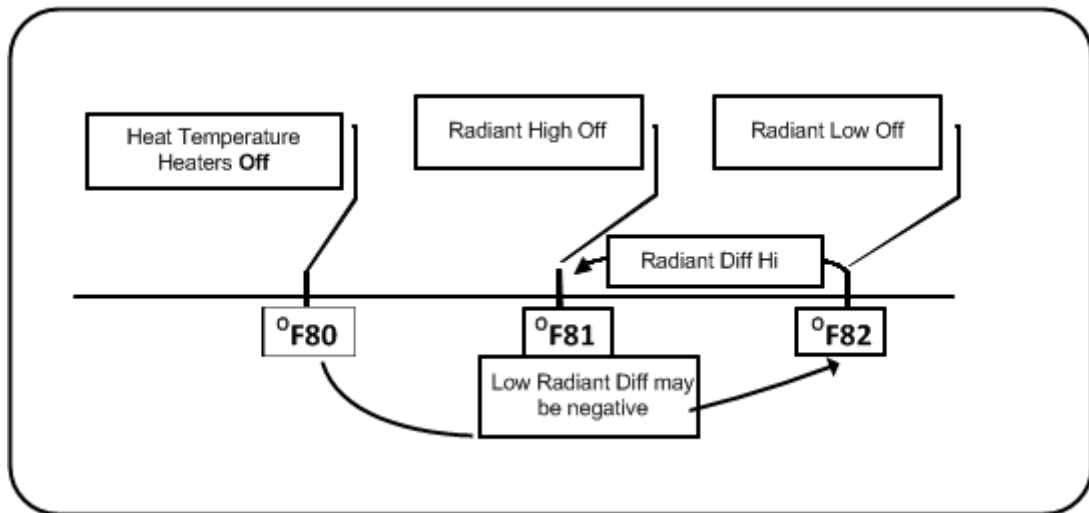

Figure 1: Radiant Heater Differentials

### 3.1.3 CYCLE HEATERS | SET DEFINITIONS

Heat Cycle means providing heat in conjunction with the ventilation system during minimum ventilation cycles, **using heaters and fans connected to relays**. When enabled, heaters operate during the fans' cycle off time (as defined in the Levels of Ventilation Cycle Timer On and Off parameters). How does it work?

Between the Heat Temperature and the differential temperature, heaters do not operate. When the temperature goes below the Heat Off temperature minus the Low Heat Differential:

- Heaters begin to operate when the exhaust or tunnel fans are off. Heaters operate for the Minimum On Time.
- If the temperature continues to drop, heaters operate for longer periods of time, up to the Maximum On Time (defined in Levels of Ventilation).
- AC-2000 3G automatically generates a curve.

In this example:

- Temperature Curve Heat Off is 78°.
- Low Heat Differential is 1°.
- High Heat Differential is 8°.
- Minimum On time is 30 seconds.
- Cycle Off time is 270 seconds.

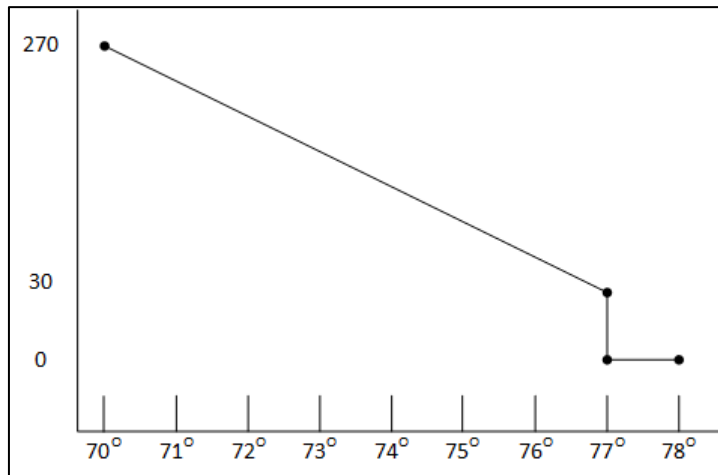

1. Define the required number of heater and exhaust and/or tunnel relays (Relay Layout, page 80).
2. In Control > Control Mode, set the Heater Cycle to Yes.
3. In Control > Temperature Curve > Help, scroll to Cycle Heater.
4. Define:
  - Low Heat Differential: The differential below the Heat Off temperature, at which heating begins and runs for the minimum amount of time.
  - High Heat Differential: The differential below the Heat Off temperature, at which heating runs for the maximum amount of time
  - Minimum ON Time: Minimum heating time when the exhaust or tunnel fans are off.

### 3.1.4 VARIABLE HEATER HELP | SET DEFINITIONS

The AC-2000 3G Controller enables configuring up to two variable heaters. The heater output changes according to the output of a 0 - 10 VDC device.

#### To configure the variable heaters:

1. In *Installation > Analog Output* configure:
  - a. up to two analog outputs as variable heaters
  - b. the minimum and maximum voltage output for each heater

ANALOG OUTPUT			
Out No.	Output Function	Min V.Out	Max V. Out
1	Var. Heater 1	1.0	10.0
2	Var. Heater 2	1.0	10.0

2. In *Control > Control Mode > Analog Heat Mode*, define the mode.

- Linear Heat
- Proportional Heat
- Linear Valve

Refer to Control Mode, page 29 for details.

3. In Control > Temperature Curve > Help, define the parameters for each mode.

### 3.1.4.1 Linear Heat

When Linear Mode is enabled:

- Between the Heat Temperature and the Target temperature, heaters do not operate (meaning, the output voltage is 0).
- Between the Heat Temperature and the Low Difference Below Heat, heaters operate at the minimum voltage output.
- If the temperature continues to drop, the voltage output increases until it reaches the maximum voltage output at the High Difference below Heat.

In this example:

- Target Temperature is 80°
- Temperature Curve Heat Off is 78°.
- Low Heat Differential is 1°.
- High Heat Differential is 8°.
- If the temperature is between 77° to 78°, the output voltage is the minimum voltage defined in Installation > Analog Output (1 volt in this example).
- If the temperature continues to drop, the output voltage increases until it reaches the maximum voltage defined in Installation > Analog Output. Output increases or decreases to keep the temperature within the Target Temperature and Heat Off band.

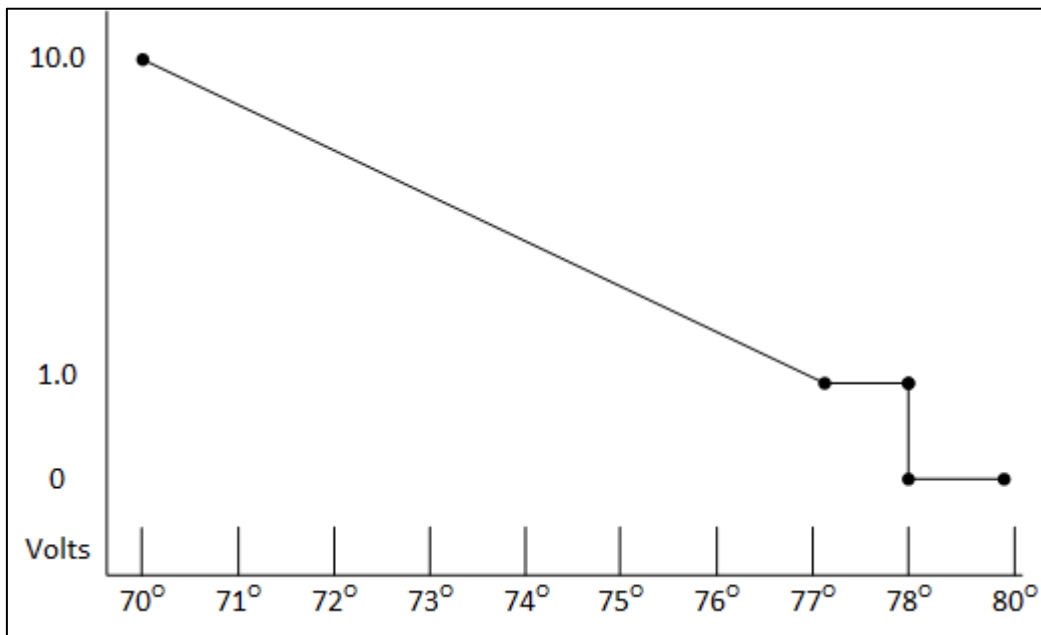

SYSTEM PARAMETERS	
<b>RADIANT HEATERS</b>	
Rad. Low -Diff from Heat Set	0.0
Rad. High -Diff (Below Low Set)	1.0
Radiant Ignition Time (sec)	30
<b>VARIABLE HEATER</b>	
Low Diff Below Heat	1.0
High Diff Below Heat	8.0

- Define the parameters:
  - **Low Difference Below Heat:** Temperature difference between the Heat Off parameter at which the variable heater begins to function.

- **High Difference Below Heat:** Temperature at which the heater begins to operate at maximum output.

### 3.1.4.2 Proportional Heat

Proportional Heat works in manner similar to Linear Mode. The difference is that Proportional Heat features a delay time.

- When the temperature falls below the user-defined point, the heaters begin operating at their minimum output.
- After the response time passes, AC-2000 3G checks the temperature. If it is still below the defined point, AC-2000 3G increases the voltage by a certain amount (this amount of the increase cannot be changed).
- After the response time passes, the process is repeated until heaters operate at their maximum output.

SYSTEM PARAMETERS	
<b>RADIANT HEATERS</b>	
Rad. Low –Diff from Heat Set	0.0
Rad. High –Diff (Below Low Set)	1.0
Radiant Ignition Time (sec)	30
<b>VARIABLE HEATER</b>	
Diff Above Heat to Stop Heater	1.0
High Diff Below Heat	8.0
Response Time (seconds)	15

- Define the parameters.
  - **Difference Above Heat to Stop Heater:** Differential from target temperature at which the heater runs at minimal input
  - **High Difference Below Heat:** High Difference Below Heat: Temperature at which the heater begins to operate at maximum output
  - **Response Time (seconds):** Amount of time before the controller begins to change the ventilation.

### 3.1.4.3 Linear Valve

SYSTEM PARAMETERS	
<b>RADIANT HEATERS</b>	
Rad. Low –Diff from Heat Set	0.0
Rad. High –Diff (Below Low Set)	1.0
Radiant Ignition Time (sec)	30
<b>VARIABLE HEATER</b>	
Low Diff Below Heat	1.0
High Diff Below Heat	8.0

Linear Valve enables defining that variable heater input voltage is always equal to or above the minimum input defined in Installation > Analog Sensors..

When the Analog Heat Mode is defined as having Linear Valve control, there is always a minimal voltage input. Therefore, if the minimum voltage is 1 volts:

- The voltage range is from 1 to 10 volts
  - this corresponds to 10% at 1V and 100% at 10V

- interpolation inside the band
- There is 0% voltage when the target temperature is reached.

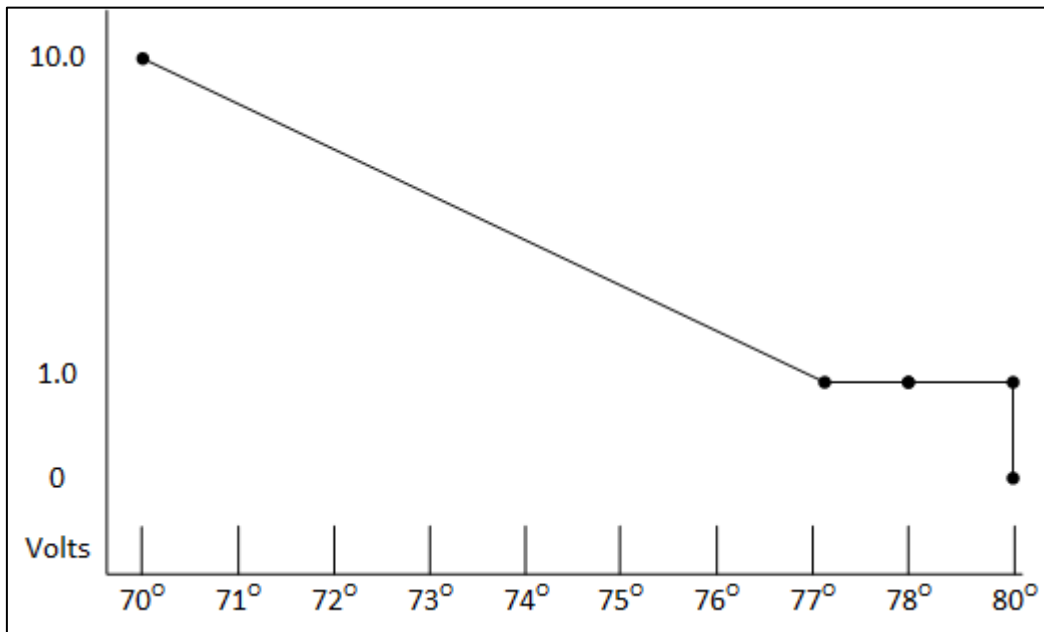

- Define.
  - **Difference Above Heat to Stop Heater:** Differential from target temperature at which the heater runs at minimal input
  - **High Difference Below Heat:** High Difference Below Heat: Temperature at which the heater begins to operate at maximum output.

### 3.1.5 VARIABLE FLOOR HEATER | SET DEFINITIONS

SYSTEM PARAMETERS	
<b>RADIANT HEATERS</b>	
Rad. Low -Diff from Heat Set	0.0
Rad. High -Diff (Below Low Set)	1.0
Radiant Ignition Time (sec)	30
<b>VARIABLE HEATER</b>	
Low Diff Below Heat Tmp.	0.5
High Diff Below Heat Tmp.	4.5
<b>VARIABLE FLOOR HEATER</b>	
Low Diff Below Heat Tmp.	0.5
High Diff Below Heat Tmp.	4.5

AC-2000 3G Controllers enable configuring up to two variable floor heaters. The output of the heaters changes as the temperature increases or decreases.

➔ **Install at least one analog output card.**

**To configure the variable floor heaters:**

1. In *Installation > Analog Output* configure:
  - a. up to two analog outputs as variable heaters
  - b. the minimum and maximum voltage output for each heater

ANALOG OUTPUT			
Out No.	Output Function	Min V.Out	Max V. Out
1	Var. Heater 1	1.0	10.0
2	Var. Heater 2	1.0	10.0

2. In *Control > Temperature Curve > Help*, scroll down to Variable Floor Heater.
3. Set the response time (amount of time before the controller begins to change the ventilation).
4. Variable heat parameters are dependent on the mode employed.
  - Linear Heat
  - Proportional Heat
  - Linear Valve

### 3.2 Introduction to Humidity, Ammonia, and CO2 Treatment

AC-2000 3G provides various options to controlling the humidity, CO2, and ammonia levels.

- **None:** No treatment is provided.
- **Level:** Ventilation levels increase for a designated amount of time.
- **Tunnel or exhaust fan:** A designated fan turns on for a designated amount of time. The amount of air blown into the house is greater than that provided by an increase in ventilation level.
- **Increase in air / weight:** The total amount of air that fans need to provide increases by a user defined amount. Fan stay on until CO2, humidity, or ammonia levels fall to their defined levels. This option is only available when using Minimum Ventilation by Weight.
- **Humidity treatment by heat:** In cold air situations, heaters can be turned on to lower the relative humidity.

If there is a contradiction between CO2, humidity, and ammonia treatments:

- Ammonia treatment has priority over CO2 treatment.
- CO2 treatment has priority over humidity treatment.
- Increase in air / weight has priority over other treatments.
- Humidity treatment by heat takes priority over increasing the ventilation.

### 3.3 Humidity Treatment

Humidity treatment forces an increase in ventilation level when the humidity is too high. It holds the increase for 'Duration Seconds', and checks back after 'Interval Minutes' for another increase. After the duration, the ventilation level comes back down automatically.

HUMIDITY TREATMENT			
Day	Humidity	Delay (Min)	Duration (sec.)
1	70	10	130
7	75	7	150
14	80	5	180
0	0	0	0
0	0	0	0
0	0	0	0
0	0	0	0
0	0	0	0

1. In *Install > Analog Sensors* (refer to Analog Sensors, page 81), designate up one or two sensors as indoor humidity sensors (outdoor sensor is for information only). When using more than one sensor, AC-2000 3G begins treatments based on the average.
2. If required, go to *Service > Humidity Calibration*, and calibrate the sensors (refer to CO2 Sensor Calibration, page 72).
3. In *Control > Humidity Treatment* set the parameters as required.
  - **Day:** Growth day. Can set multiple programs for same day (maximum number of programs: 20)
  - **Humidity:** Humidity at which to begin treatment
  - **Delay Minute:** Amount of time the controller pauses before ventilating
  - **Duration Sec.:** Number of seconds the controller maintains the increased level of ventilation
4. Set the Humidity Sensor Alarm (page 55).

### 3.3.1 HUMIDITY TREATMENT HELP | SET DEFINITIONS

- ② While viewing the Humidity Treatment menu: Press **HELP**, select **SET**, and press **ENTER**.

HUMIDITY TREATMENT	
Humidity Band (%)	5.0
Humidity Treatment below Heat	YES
Humidity Treatment By	Exh 6
HUMIDITY TREATMENT BY HEATERS	
Humidity Treatment by Heaters	YES
Outside Temp Treat by Heaters	-18.0
Diff to Stop Treatment by Heaters	3.6

- **Define:**
  - **Humidity Band (%):** Hysteresis band (delay) for Humidity Treatment.
  - **Humidity Treatment below Heat:** Select YES or NO for allowing Humidity Treatment when heaters are operating (set in Temperature Curve).
  - **Humidity Treatment By:** This parameter designates the method used when humidity or CO2 treatment begins. Normally, this parameter is relevant only when minimum ventilation is running. When a treatment is required, select one the method to be employed:
    - Level: Increases the ventilation level when a treatment is required.

*NOTE* When employing Ventilation by Weight, the controller increases the cycle time or the level, depending on the particular settings.

- Exhaust: Designate a specific exhaust fan (press a number key to select the fan).

- Tunnel: Designate a specific tunnel (press a number key to select the fan).
- None: Disables the treatment.

➡ To enable the exhaust/tunnel options, in *Installation > Relay Outlet* or *Installation > Analog Output*, designate at least one relay/variable device as a tunnel or exhaust fan.

- Humidity Treatment by Heaters: This parameter enables using the heaters to lower the relative humidity. If enabled, define:
  - Outside Temp Treat by Heaters: Heaters handle humidity treatment when the **outside** temperature is lower than the target temperature by this amount.
  - Diff to Stop Treatment by Heaters: Heaters cease the humidity treatment if the **inside** temperature is lower (or higher) than the target temperature by this amount. This number can be positive or negative.

➡ Humidity Treatment by Heaters requires designating at least one temperature sensor as an outside sensor (refer to Temperature Definition, page 85).

*NOTE* If the heaters are operating because of the interior temperature, Humidity Treatment by Heaters is disabled.

### 3.4 CO2 Treatment

CO2 treatment forces an increase in ventilation level when the CO2 level is too high. It holds the increase for 'Delay Seconds', and checks back after 'Interval Minutes' for another increase. After the duration, the ventilation level may come back down automatically. If during treatment, the CO2 level drops below the **Stop Value** parameter, the ventilation level automatically returns to that level used before CO2 treatment was initiated.

CO2 TREATMENT				
Day	Start Value	Stop Value	Delay (sec)	Duration (sec)
1	3000	2500	120	130
7	2700	2200	120	150
14	2500	2000	90	180
0	0	0	0	0
0	0	0	0	0
0	0	0	0	0
0	0	0	0	0
0	0	0	0	0
0	0	0	0	0
0	0	0	0	0

1. In *Install > Analog Sensors* (refer to Analog Sensors, page 81), designate one sensor as a CO2 sensor.
2. If required, go to *Service > CO2 Calibration*, calibrate the sensors (refer to Analog Sensors, page 81).
3. In *Control > CO2 Treatment* set the parameters as required.
  - **Day:** Growth day. Can set multiple programs for same day (Max. programs 20)
  - **Start Value:** CO2 value at which to begin treatment
  - **Stop Value:** CO2 value at which to end treatment
  - **Delay (Sec):** Number of seconds the controller pauses before ventilating
  - **Duration (Sec):** Number of seconds the controller maintains the increased level of ventilation
4. Set the CO2 Sensor Alarm (page 55).



### 3.4.1 CO2 TREATMENT HELP | SET DEFINITIONS

- ② While viewing the CO2 Treatment menu: Press **HELP**, select **SET**, and press **ENTER**.

SYSTEM PARAMETERS	
CO2 TREATMENT	
CO2 Treatment Below Heat	NO
CO2 Treatment By	Exh 6
CO2 TREATMENT BY HEATERS	
CO2 Treatment by Heaters	YES
Outside Temp Treat by Heaters	-18.0
Diff to Stop Treatment by Heaters	3.6

- **CO2 Treatment below Heat:** Select **YES** or **NO** to enable CO2 treatment when heaters are operating (set in [Control | Temperature Curve](#)).
- **CO2 Treatment By:** This parameter designates the method used when humidity or CO2 treatment begins. Normally, this parameter is relevant only when minimum ventilation is running. When a treatment is required, select one the method to be employed:
  - Level: Increases the ventilation level when a treatment is required.

*NOTE* When employing Ventilation by Weight (refer to page 22), the controller increases the cycle time or the level, depending on the particular settings.

- Exhaust: Designate a specific exhaust fan (press a number key to select the fan).
  - Tunnel: Designate a specific tunnel (press a number key to select the fan).
  - None: Disables the treatment.
- ➔ To enable the exhaust/tunnel options, in *Installation > Relay Outlet* or *Installation > Analog Output*, designate a relay/variable device as a tunnel or exhaust fan.
    - CO2 Treatment by Heaters: This parameter enables running the heaters in situations where the CO2 level is high. Typically this can happen in cold temperatures when CO2 is produced by the heaters. By increasing the heat in the house, ventilation can then be increased. If enabled, define:
      - Outside Temp Treat by Heaters: Heaters handle CO2 treatment when the **outside** temperature is lower than the target temperature by this amount.
      - Diff to Stop Treatment by Heaters: Heaters cease the CO2 treatment if the **inside** temperature is lower (or higher) than the target temperature by this amount. This number can be positive or negative.
  - ➔ CO2 Treatment by Heater requires designating at least one temperature sensor as an outside sensor (refer to Temperature Definition, page 85).

*NOTE* If the heaters are operating because of the interior temperature only, CO2 Treatment by Heater is disabled.

### 3.5 Min/Max Level

- ➔ **IMPORTANT:** Before setting Min/Max levels, go through and set up the Device Settings, especially the ventilation levels.

Once you have entered the ventilation levels, use Min/Max to select the range of levels to apply to your situation. Typically, you increase the minimum ventilation level as litter conditions deteriorate and the

birds require greater amounts of fresh air. You can also restrict the maximum level to prevent excess airflow on young birds.

Use one of the following methods to set the Min/Max levels:

- By Day and By Soft Days Curve
- By Time
- Day Soft Min.
- By Weight

➡ Before configuring these parameters, go to *Control Mode > Min. Max. Level Control* (page 28) to select the required method.

### 3.5.1 BY DAY AND BY SOFT DAYS CURVE

MIN/MAX LEVEL		
Day	Min	Max
1	1	16
3	2	16
6	3	16
10	4	16
14	5	21
21	6	21
35	7	21
0	0	0
0	0	0
0	0	0

- **Day:** Set growth day
- **Min:** Set the controller's minimum ventilation level
- **Max:** Set the controller's maximum ventilation level
  - BY DAYS CURVE generates an incremental increase/decrease between the defined days.
  - BY DAYS operates according to that day's values until the next defined day is reached.

### 3.5.2 BY TIME

MIN/MAX LEVEL		
From	Min	Max
06:00	1	6
10:00	4	8
13:00	6	12
18:00	8	15
21:00	1	3
00:00	0	0
00:00	0	0
00:00	0	0
00:00	0	0
00:00	0	0

- **From:** Set time of day (hh:mm) in 24 hour format
- **Min:** Set minimum ventilation level for controller
- **Max:** Set maximum ventilation level for controller

### 3.5.3 DAY SOFT MIN.

SOFT MIN/MAX LEVEL			
Day	Min Soft	Min	Max
1	1	11	16
3	2	11	16
6	3	11	16
10	4	11	16
14	5	11	21
21	6	11	21
35	7	11	21
0	0	0	0
0	0	0	0
0	0	0	0

- **Day:** Set growth day
- **Min Soft:** Set minimum ventilation level for when temperature drops below heat temperature
- **Min:** Set minimum ventilation level for when temperature is above heat temperature
- **Max:** Set maximum ventilation level for controller

#### 3.5.3.1 Soft Min/Max Level Help | Set Definitions

① While viewing the **Soft Min/Max Level** menu: Press **HELP**, select **SET**, and press **ENTER**.

SYSTEM PARAMETERS	
SOFT MIN/MAX LEVEL	
Diff. Below Heat for Soft Min.	10.0
Temp Choice for Soft Min. ▶	ATTIC

- **Differential Below Heat for Soft Min:** Set the degree of difference from heat temperature (set in [Control | Temperature Curve](#)) to switch minimum level from **Min.** to **Soft Min.**
- **Temp Choice for Soft Min:** Select inside/outside/attic temperature to control Minimum Level changes. The minimum level adjusts towards the Soft Min as this temperature falls. Above the heat temperature, the minimum level is at the Min setting.

As temperature rises, **INSIDE** and **ATTIC** stay at lowest ventilation level reached until average temperature gets to the heat setting, and then changes instantly. With the **OUTSIDE** selection, the minimum ventilation level increases gradually as temperature rises to the heat setting. This means inside and attic soft min vent choices to latch to the lowest level reached as long as the temperature remains below the heat setting.

### 3.5.4 BY WEIGHT

The By Weight option enables controlling the minimum air flow depending on the number of birds, their weight and the current outside temperature. When using the Weight option, AC-2000 3G takes several parameters and calculates the air speed, level of ventilation and cycle time needed to supply the required volume. As opposed to the other ventilation methods, the Weight option is dynamic, with the ventilation changing according to the current parameters (quantity of air required, weight of birds and number of birds, outside air temperature). In addition, Ventilation By Weight sends out an alarm if the current ventilation is below the minimum required level.

#### To set up the Weight Option:

1. In *Install > Setup* (page 79) enable Minimum Vent (Power).

2. In *Install > Fan Air Capacity*, define the air capacity / hour (page 86).
3. In *Management > Bird Inventory*, define the number of birds.
4. In *Scale > General Setting*, select the curve.
5. In *Scale > Bird Curve*, define the growth days and weights as required.
6. In *Control > Control Mode > Min. Max Level Control*, select **Weight**.
7. In *Control > Min/Max Level*, set the parameters as required.

SOFT MIN/MAX LEVEL BY WEIGHT (OUT TEMP)				
Day	Min Level	Air Per Kg/Lb		Max Level
		Cold	Warm	
1	1	0.5	1.5	16
3	1	0.5	1.5	16
6	1	0.5	1.5	16
10	4	1.1	1.7	16
12	4	1.1	1.7	21
15	7	1.1	1.7	21
17	7	1.1	1.7	21
19	7	1.1	1.7	21
21	7	1.1	1.7	21
350	70	0	1.7	22

- **Day:** Set growth day
- **Min Level:** Set the minimum level of ventilation (refer to Levels of Ventilation, page 33)
- **Air Per Kg/Lb:** Volume of air per kilogram/pound per hour per bird.
  - Cold: Volume of air supplied when the outside temperature goes down to the *Cold Temperature* parameter (see the following section).
  - Warm: Volume of air supplied when the outside temperature reaches *Warm Temp. - Diff Below Heat* (see the following section).

*NOTE As the level rises between days (for example between day 6 and day 10 in the screen above), the air volume rises proportionally each day, once a day. For example, on Day 7, the Cold Air per Kg/Lb. rises to 0.65; on Day 8, 0.8 and so on.*

- **Max Level:** Set the maximum level of ventilation (refer to Levels of Ventilation, page 33).

8. In the *Management > Bird Inventory* menu, type the number of birds.
9. In the Help menu, define the parameters as required.

Ventilation by Weight is configured.

- Min/Max Level By Weight Help | Set Definitions, Version 9.18 and Below
- Min/Max Level By Weight Help | Set Definitions Version 9.19
- Weight Hot Screen

### 3.5.4.1 Min/Max Level By Weight Help | Set Definitions, Version 9.18 and Below

② While viewing the Min/Max Level by Weight menu: Press **HELP**, select **SET** and press **ENTER**.

SYSTEM PARAMETERS	
<b>SOFT MIN/MAX LEVEL BY WEIGHT</b>	
Warm Temp. – Diff Below Heat	2.0
Cold Temperature	68.0
Air Change	0.24
Fan Cycle Time (sec, 0 – Manual)	600
Minimum ON Time in Vent Cycle	60
Minimum OFF Time Vent Cycle ▶	60
Air Change by Humidity/CO2 %	20
Air Per Weight Curve Mode	2

- **Warm Temperature – Difference Below Heat:** Differential below the heat temperature (refer to Temperature Curve, page 9) that defines outside temperature as Warm in the Soft Min/Max table. For example, if the Heat Temperature is 78° F, Warm Temp. – Diff Below Heat is 2.0, than the outside temperature is defined as warm at 76° F.
- **Cold Temperature:** Outside temperature (or below) at which **Air per Kg/Lb (Cold)** capacity is reached.

When the outside temperature is between the Warm and Cold Temperature, the flow rate is calculated at a proportional rate.

- **Air Change:** As the temperature rises from the Cold Temperature parameter to the Heat Temperature (or drops from the Heat Temperature to the Cold Temperature parameter), the minimal air volume rises/falls proportionally. Air Change defines the minimal change in air temperature that must takes place to cause a change in the air supply.
- **Fan Cycle Time:** The total amount of time that the fans operate while operating under Minimum Ventilation. During this time, the fans supply the required volume of air at the minimum ventilation level required. Platinum Pro/Rotem Pro adjusts the minimum ON time and OFF time as needed. If the fans cannot supply the required volume at a particular level of ventilation, the controller automatically adjusts the minimum ventilation level.
  - **Minimum ON Time in Vent Cycle:** The minimum amount of time that the fans operate during a cycle. The controller adjusts the actual fan time as needed.
  - **Minimum OFF Time in Vent Cycle:** The minimum amount of time that the fans do not operate during a cycle. The controller adjusts the actual fan time as needed.

As the temperature rises, the actual Minimum OFF Time decreases until it reaches the minimum time. Only then does the Minimum On Time begin to rise.

*NOTE If the temperature goes above the Band Temperature, Power Ventilation begins and times are adjusted accordingly.*

- **Air Change By Humidity/CO2/Ammon%:** As the humidity, CO2, or ammonia levels rise above the levels specified in Humidity Treatment, CO2 Treatment, or Ammonia Treatment the minimal air volume rises proportionally. Air Change By Humidity/CO2/Ammon% defines the minimal change in in these levels that must take place to cause an increase in the air supply.
- **Air Per Weight Curve Mode:** By default, Air per Kilo/Lb has two data points: cold temperature and warm. If desired, the user can add an additional intermediate (**computer defined**) data point which is between the two default points. This point determines the quantity of air to be distributed when the temperature reaches the midpoint between the cold and warm temperatures.

SOFT MIN/MAX LEVEL BY WEIGHT (OUT TEMP)					
Day	Min Level	Air Per Kg/Lb			Max Level
		Cold	Warm		
1	1	0.5	0.9	1.5	16
3	1	0.5	0.9	1.5	16
6	1	0.5	0.9	1.5	16
10	4	1.1	1.4	1.7	16
12	4	1.1	1.4	1.7	21
15	7	1.1	1.4	1.7	21
17	7	1.1	1.4	1.7	21
19	7	1.1	1.4	1.7	21
21	7	1.1	1.4	1.7	21
35	7	0	1.4	1.7	22

*NOTE* In a three point curve, the intermediate value must be between the cold and warm value in each line.

### 3.5.4.2 Min/Max Level By Weight Help | Set Definitions Version 9.19

Version 9.19 has an additional parameter, Medium Temp, which enables setting up a more accurate temperature curve in Air by Weight. By default, the curve is determined by the Air per Kg/Lb Cold and Warm Temperatures. Medium Temp adds an additional (**user-defined**) point to the curve.

#### To add the Medium Temp point:

1. Configure Air by Weight as shown in By Weight, page 22.
2. Go to Control > Min/Max > Help and configure the parameters (refer to Min/Max Level By Weight Help | Set Definitions, Version 9.18 and Below, page 24 for details).
3. In the Help screen, define the Air per Weight Curve Mode:
  - Using the number pad keys to define the mode as 2 or 3.
    - If set to 2, the Medium Temp parameter is disabled.
    - If set to 3, define the Medium Temp parameter.

SYSTEM PARAMETERS	
<b>SOFT MIN/MAX LEVEL BY WEIGHT</b>	
Warm Temp. – Diff Below Heat	2.0
Medium Temp	72.0
Cold Temperature	68.0
Air Change	0.24
Fan Cycle Time (sec, 0 – Manual)	600
Minimum ON Time in Vent Cycle	60
Minimum OFF Time Vent Cycle ▶	60
Air Change by Humidity/CO2/Ammon% %	20
Air Per Weight Curve Mode	3

- It can be no lower than the Cold Temperature.
- It can be no higher than the Warm Temperature minus Warm Temp. –Diff below Heat differential.
- Go to the Control Menu screen, re-enter the Mini/Max screen, and the Medium Weight parameter appears.

SOFT MIN/MAX LEVEL BY WEIGHT (OUT TEMP)					
Day	Min Level	Air Per Kg/Lb			Max Level
		Cold	Med	Warm	
1	1	0.5	0.9	1.5	16
3	1	0.5	0.9	1.5	16
6	1	0.5	0.9	1.5	16
10	4	1.1	1.4	1.7	16
12	4	1.1	1.4	1.7	21
15	7	1.1	1.4	1.7	21
17	7	1.1	1.4	1.7	21
19	7	1.1	1.4	1.7	21
21	7	1.1	1.4	1.7	21
35	7	0	1.4	1.7	22

### 3.5.4.3 Weight Hot Screen

Selecting the Ventilation by Weight option enables an additional Hot Screen, the Air Status Screen. This screen displays the critical parameters involved in the Ventilation by Weight option.

AIR STATUS				
Inside Temp	24.1			
Outside Temp	21.3			
Humidity	46.7%			
Weight KG	0.468			
	Current	Min	Max	
Level	2	1	2	
Cycle On	30	30	30	
Cycle Off	98	134	66	
Total Air	M3/h	8347	6552	11232
M3/h				
Air/WGT	M3h/kg	0.9	0.7	1.20

- **Inside Temperature:** Current temperature inside the house
- **Outside Temperature:** Current temperature outside the house
- **Humidity:** Current relative humidity inside the house (requires a humidity sensor)
- **Weight KG:** Current average weight of the Bird Curve (page 59)
- **Level:** Displays the current, minimum and maximum level of ventilation.

*NOTE If the current level is below the minimum required level, AC-2000 3G displays an alarm "Below Min Air".*

- **Cycle On/Off:** Displays the current, minimum and maximum fan on and off times.
- **Total Air M3/h:** Displays the current, minimum and maximum quantity of ventilation, per hour.
- **Air/WGT:** Displays the current amount of ventilation, per kilo/pound of bird weight.

## 3.6 Static Pressure

This screen sets target parameters for Static Pressure at High and Low Outside Temperatures, as well as alarms for high and low static pressure.

STATIC PRESSURE	
<b>Minimum Ventilation</b>	
S.Press. At Low Temperature	0.120
S.Press. At High Temperature	0.080
Low Static Pressure Alarm	0.010
High Static Pressure Alarm	0.150
Static Pressure Band	0.040
<b>Tunnel Ventilation</b>	
Target Static Pressure	0.080
Low Static Pressure Alarm	0.010
High Static Pressure Alarm	0.150
Static Pressure Band	0.040
<b>Attic</b>	
Target Static Pressure	0.050

- Disabling the Static Pressure Sensor
- Static Pressure Help | Set Definitions
- Multi Stage Tunnel Curtains

### Minimum Ventilation

- **Static Pressure at Low Temp:** Set desired static pressure for low outside temperature conditions. Be sure that there is proper airflow at this setting.
- **Static Pressure at High Temp:** Set desired static pressure for high temperature conditions. Normally this pressure is lower to obtain a larger air inlet opening.

*NOTE The controller interpolates between the LOW and HIGH Temperatures. If Static Pressure exists, it is controlled by the outside temperature sensor or the average temperature (if there is no sensor).*

- **Low Static Pressure Alarm:** Set alarm for low static pressure. If you disable it by setting zero, the AC-2000 3G warns you and enters a record in the Table of Events.
- **High Static Pressure Alarm:** Set alarm for high static pressure.
- **Static Pressure Band:** Set desired band for the target pressure.

### Tunnel Ventilation

- **Target Static Pressure:** Set required Static Pressure for Tunnel Ventilation Mode.
- **Low Static Pressure Alarm:** Set alarm for low static pressure.
- **High Static Pressure Alarm:** Set alarm for high static pressure.
- **Static Pressure Band:** Set required band for pressure in tunnel ventilation mode.

### Attic

- **Target Static Pressure:** Set required Static Pressure when in attic mode.
- **Static Pressure Band:** Set required band for attic ventilation mode.

### 3.6.1 DISABLING THE STATIC PRESSURE SENSOR

To disable the static pressure sensor:

1. Go to *Installation > Setup*.



2. Set the Static Pressure Unit to **None**.

The main screen stops:

- displaying the pressure
- displaying High Pressure and Pressure Sensor Failure alarms

If either of these alarms were active before disabling the sensor, the main screen continues to display the alarms. Reset the alarms one time to cease the display.

### 3.6.2 STATIC PRESSURE HELP | SET DEFINITIONS

② While viewing the Static Pressure menu: Press **HELP**, select **SET**, and press **ENTER**.

SYSTEM PARAMETERS	
<b>STATIC PRESSURE</b>	
Wind Gust Delay Time (sec)	10
S. Pressure During Tunnel	YES
Transitional Tunnel	NO
Minimum Ventilation Using	VENT
Low Incoming Air (diff to Trg)	-25.0
High Incoming Air (diff to Trg)	-10.0
Emergency S. Press. Delay (sec)	60
Curt. Pos. In Emerg. S. Press. %	100
Low S.P. Alarm Min. Level (MinV)	0
Low S.P. Alarm Min. Level (Tun.)	0
Time To Produce S. Pressure (sec)	10
Attic Advance Opening Time (sec)	0

- **Wind Gust Delay Time (sec):** Set length of time in seconds before starting Static Pressure control after an unexpected change in air pressure.
- **Static Pressure During Tunnel:** Select **YES** or **NO** for using Static Pressure control when in Tunnel mode.
- **Transitional Tunnel:** Select **YES** or **NO** for using tunnel curtains when static pressure is high and vents are already at 100%.
- **Minimum Ventilation Using (vent/curtain):** Select **VENT** or **CURTAIN** for controlling static pressure when in minimum ventilation.
- **Low Incoming Air (Diff to Trigger):** Define low temperature for static pressure control.
- **High Incoming Air (Diff to Trigger):** Define high temperature for static pressure control.
- **Emergency Static Pressure Delay (sec):** Set length of time in seconds before initiating an emergency opening when pressure exceeds high alarm setting.
- **Curtain Position in Emergency Static Pressure (%):** Set the desired curtain position (in percentage) when an emergency pressure event occurs.
- **Low Static Pressure Alarm Min. Level (MinV):** Below this level, the controller ignores low static pressure alarms.
- **Low Static Pressure Alarm Min. Level (Tun.):** Below this level, the controller ignores low static pressure alarms while in tunnel mode.
- **Time to Produce Static Pressure (sec):** Enter the length of time to reach target pressure when minimum ventilation fan cycle is on.
- **Attic Advance Opening Time (sec):** Define the amount of time for the attic inlets to open before minimum vent cycling fans turn on.

### 3.6.3 MULTI STAGE TUNNEL CURTAINS

When in static pressure mode and employing multiple tunnel curtains, AC-2000 3G can open the curtains in sequence. Opening the tunnel curtains commences when the target static pressure is reached and the

controller signals to the tunnel machine to operate the curtains. AC-2000 3G opens the first tunnel curtain (as defined in the relays) to the user defined level. If additional ventilation is required, the second tunnel curtain opens. This process continues for each defined curtain.

As pressure falls, the process is reversed; curtains close in progression starting with the last curtain.

**To set up Multi Stage Tunnel Curtains:**

1. In *Installation > Relays* define more than one relay as tunnel curtain (open and close).
2. In *Device > Vent & Curtain Levels*, define the opening levels for each curtain.
3. In *Static Pressure > Tunnel Ventilation*, define the target pressure.

### 3.7 Control Mode

Select house-operating modes, turn temperature curves on or off and select which type of min/max CO2 level method to use.

CONTROL MODE	
House Mode	FULL
Empty House Mode	HOUSE
Temperature Curve	HOUSE
Min. Max. Level Control	BY WEIGHT
Heat Cycle	NO
Analog Heat Mode	LINEAR

- **House Mode:** Select whether the house is in one of the brood set ups, or in full house.
- **Empty House Mode:** Select YES in order to disable alarms.
- **Temperature Curve:** If you select OFF, temperature settings become fixed values until midnight on the next setting in [Control | Temperature Curve](#) (page 9).
- **Min. Max. Level Control:** Set ventilation control method (By Days, By Days Curve, By Time, By Soft Min, and Weight). Refer to Min/Max Level, page 20 for more details).
- **Heat Cycle:** Enable cycle heaters. Refer to Cycle Heaters | Set Definitions, page 12.
- **Analog Heat Mode:** Define the variable heating mode (Linear, Proportional, Linear Valve). Refer to Variable Heater Help | Set Definitions, page 13.

### 3.8 System Parameters

System Parameters consolidates all of the **HELP | SET** menus into one screen.

System Parameters	Page
Temperature Curve	9
Radiant Heaters Help   Set Definitions	11
CO2 Treatment Help   Set Definitions	19
Static Pressure Help   Set Definitions	27
Levels of Ventilation Help   Set Definitions	34
Curtains	37
Vent/Curtain Help   Set Definitions	84
Attic	27

System Parameters	Page
Cool Pad Help   Set Definitions	41
Cool Pad Flush	41
Foggers Help   Set Definitions	42
Light Help   Set Definitions	44
Water and Feed Help   Set Definitions	46
Feed Inventory Help   Set Definitions	51
Alarm Setting Help   Set Definitions	54

### 3.9 Ammonia Treatment

Ammonia treatment forces an increase in ventilation level when the ammonia level is too high. To prevent fans changing their ventilation too often, treatment begins after a user-defined delay. The user also defines the treatment duration.

After the treatment, the ventilation level may come back down automatically if the house temperature is below the target temperature. Otherwise, the ventilation level does not change. If during treatment, the ammonia level drops below the **Stop Value** parameter, the ventilation level automatically returns to that level used before ammonia treatment began.

AMMONIA TREATMENT				
Day	Start Value	Stop Value	Delay (Sec)	Duration Sec.
1	25	10	120	130
7	25	10	120	150
14	25	10	90	180
0	25	10	0	0
0	25	10	0	0
0	25	10	0	0
0	25	10	0	0
0	25	10	0	0
0	25	10	0	0
0	25	10	0	0

➔ This function requires an ammonia sensor.

1. In *Install > Analog Sensors* (refer to Analog Sensors), designate one sensor as an ammonia sensor.
2. If required, go to *Service > Ammonia* and calibrate the sensors (refer to Ammonia Calibration).
3. In *Control > Ammonia Treatment* set the parameters.
  - **Day:** Growth day. You can set multiple programs for same day (maximum number of programs: 20)
  - **Start Value:** Ammonia value at which to begin treatment. Range: 0 to 100. Default: 2

*NOTE Ammonia levels should not be higher than 30 ppm.*

- **Stop Value:** Ammonia value at which to end treatment. Range: 0 to 100. Default: 2. The stop value must be lower than the start value.
- **Delay (Sec):** When the ammonia level reaches the start value, the controller delays treatment for this amount of time. Default: 0

- **Duration (Sec):** Number of seconds the controller maintains the increased level of ventilation. Default: 0

4. Set the Ammonia Alarm (page 55).

### 3.9.1 AMMONIA TREATMENT HELP | SET DEFINITIONS

- ① *While viewing the Ammonia Treatment menu: Press HELP, select SET, and press ENTER.*

SYSTEM PARAMETERS	
AMMONIA TREATMENT	
Ammonia Treatment Below Heat	No
Ammonia Treatment By	Level

- **Ammonia Treatment below Heat:** Select: Select YES or NO to enable Ammonia Treatment when heaters are operating (set in Temperature Curve).
- **Ammonia Treatment By:** This parameter designates the method used when ammonia treatment begins. Normally, this parameter is relevant only when minimum ventilation is running. When a treatment is required, select the method to be employed:
  - **Level:** Increases the ventilation level when a treatment is required.

*NOTE* When employing Ventilation by Weight, the controller increases the cycle time or the level, depending on the particular settings.

- **Exhaust:** Designate a specific exhaust fan (press a number key to select the fan).
- **Tunnel:** Designate a specific tunnel fan (press a number key to select the fan).
- **None:** Disables the treatment.

# 4 Device Menu

The AC-2000 3G can have many closely spaced levels of ventilation enabling it to find the optimum average airflow for the poultry facility. Many of the levels are at exactly the same temperature setting, so there may be a question as to how the AC-2000 3G chooses the correct level. The menus in this section apply levels to ventilation, variable speed fans, curtains, and so on. The levels in the various menus are consistent with each other so that a level in one menu corresponds with that level in any other menu.

The rules that apply here are:

- **Rule 1:** If the temperature is at target (in the Happy Zone) stay at the current level.
- **Rule 2:** If the temperature moves outside the Happy Zone wait for a few minutes.
- **Rule 3:** After waiting increase or decrease level appropriately.

You can find the 'patience' factors under [HELP | SET](#) in this menu. They are the increase level delay and decrease level delay parameters. The factory default values are 180 seconds for an increase and 60 seconds for a decrease. The factory default values biases the AC-2000 3G slightly toward warmer temperatures, as would be appropriate for young birds. The level increase delay is longer than the level decrease delay. You may wish to reverse these values by the time you have market age broilers, since they are more sensitive to heat stress than to cold.

Although many of the levels have 0.0 differential temperatures, certain levels should have differentials to account for wind chill on the birds. The first tunnel level accounts for wind chill by switching to the tunnel temperature instead of target temperature. Higher tunnel levels require an additional wind chill because of the increased airflow.

In addition, the last few levels before entering tunnel can form a transitional region. You may want to build differentials from target temperature just before the first tunnel level.

The controller obeys both the time delay rules and the differential temperature rules when changing levels. Tunnel exit has several additional rules, such as outside temperature restriction and the tunnel exit delay described under [HELP | SET](#). In addition, there are Cool Down and change to Min Vent on reaching the Heat temperature features described in [Control | Temperature Curve | HELP | Set](#) parameters.

The following sections detail the menu functions.

- Levels of Ventilation, page 33
- Variable Speed Fan Levels, page 35
- Vent & Curtain Levels, page 36
- Stir Fan Levels, page 37
- Stir Fan Program, page 38
- Cool Pad, page 40
- Foggers, page 42
- Light, page 43
- Water & Feed, page 45
- Extra Systems, page 47
- Water on Demand, page 48

DEVICE SETTING
1. LEVELS OF VENTILATION
2. SPEED FAN LEVELS
3. VENT & CURTAIN LEVELS
4. STIR FAN LEVELS
5. STIR FAN PROGRAM
6. COOL PAD
7. FOGGERS
8. LIGHT
9. WATER & FEED
10. EXTRA SYSTEMS
11. WATER ON DEMAND

## 4.1 Levels of Ventilation

The Ventilation table provides up to 30 ventilation levels. To program this table, start with the minimum ventilation used in the first level and increase ventilation gradually. A reasonable rule of thumb is to increase the airflow about 25% at each level. Increases in airflow up to 50% work satisfactorily with factory default settings.

1. Do one or both:
  - In *Install > Relay Outlet* (refer to page Relay Layout) define at least one relay as a Tunnel Fan or Exhaust Fan.
  - In *Install > Analog Output* (refer to page Analog Sensors) define one function as Tunnel Fan or Exhaust Fan.
2. In *Device Setting > Levels of Ventilation* configure the parameters as required.
3. Configure the Help Set parameters as required.

LEVELS OF VENTILATION								
No	Diff Deg.	On Sec	Exhaust			Tunnel		
			1	2	3	1	2	3
1	0.0	30	◇	◇	◇	■	■	■
2	0.0	45	◇	◇	◇	■	■	■
3	0.0	60	◇	◇	◇	■	■	■
4	0.0	80	◇	◇	◇	■	■	■
5	0.0	120	◇	◇	◇	■	■	■
6	0.0	160	◇	◇	◇	■	■	■
7	0.0	200	◇	◇	◇	■	■	■
8	0.0	250	◇	◇	◇	■	■	■
9	0.0	100	◇	◇	◇	■	■	■
10	0.0	120	◇	◇	◇	■	■	■
11	0.0	150	◇	◇	◇	■	■	■
12	0.0	180	◼	◼	◼	■	■	■
13	0.0	0	◼	◼	◼	■	■	■
14	0.0	150	◼	◼	◼	■	■	■
15	0.0	0	◼	◼	◼	■	■	■
16	0.0	0	◼	◼	◼	■	■	■

0.0.  
 Air Capacity: 300  
 Chill Range: ---  
 -Continuous  
 -Cycle  
 -Rotate  
 Tunnel Level: T

**NOTE** The number appearing under Exhaust and Tunnel is refers to the numbers defined in Installation.

- **Number:** Read-only showing the ventilation level.

**NOTE** At the First Tunnel Level (defined in the Help | Set Definitions) the screen displays the tunnel temperature (defined in Temperature Curve). ◼ means the level is in tunnel mode.

- **Differential Temperature:** Triggers next level according to difference from target temperature (time delays remain in effect).
  - The first several levels normally have differential temperature set to 0.
  - If the ventilation level is below tunnel, the differential temperature is relative to Target temperature given in [Control | Temperature Curve](#).
  - If the ventilation level is a tunnel level, the differential temperature is relative to the Tunnel temperature given in [Control | Temperature Curve](#).
- **Cycle timer ON:** Set ON time for fans for that ventilation level.
- **Cycle timer OFF:** Set OFF time for fans of that ventilation level. This parameter disappears if cycle time is set in the [HELP | SET](#) Parameters to something other than 0 and the controller calculates the "Cycle timer OFF" automatically.

- **Exhaust:** Control exhaust fans according to **Continuous, Cycle, and Rotate**.
- **Tunnel:** Control tunnel fans according to **Continuous, Cycle, and Rotate**.
- **Air Capacity:** Displays the current exhaust fan or tunnel air flow for each ventilation level. If Variable Speed Fan Levels have been set (refer to page 35), the speed percentage is taken into account.



**Continuous:** Works constantly without a break



**Rotate:** Operates according to ON/OFF timer; in each cycle a different fan operates



**Cycle:** Operates according to ON/OFF timer

#### 4.1.1 LEVELS OF VENTILATION HELP | SET DEFINITIONS

② When viewing the Levels of Ventilation menu: Press **Help**, select **Set**, and press **Enter**

SYSTEM PARAMETERS	
<b>LEVELS OF VENTILATION</b>	
Maximum Levels of Ventilation	22
First Tunnel Level	13
Max Fans, Switch to Tunnel	20
Tunnel Exit – Diff Below Tunnel	2.0
Tun Exit-Out T. Diff from Tun.	9.0
Increase Level Delay Time (sec)	120
Decrease Level Delay Time (sec)	90
Fan Cycle Time (sec, 0-Manual)	0
Tunnel Exit Delay (minutes)	2
Wind Chill Enable	NO
Wind Chill Limit	14.4
RH Effect	0.5

- **Maximum Levels of Ventilation:** Set the maximum number of levels.
- **First Tunnel Level:** Entry point to tunnel mode.
- **Max Fans, Switch to Tunnel:** Maximum number of fans allowed to operate when entering tunnel mode.
- **Tunnel Exit – Differential Below Tunnel:** Set degree of difference below Tunnel temperature (set in [Control | Temperature Curve](#)) to Exit Tunnel mode.
- **Tunnel Exit – Outside Differential from Tunnel:** The outside temperature must read below this (Tunnel + Differential) to allow exiting from tunnel mode.
- **Increase Level Delay Time (sec):** Set length of time in seconds before transitioning to next level.
- **Decrease Level Delay Time (sec):** Set length of time in seconds before transitioning to lower level.
- **Fan Cycle Time (sec):** If set to 0, set on and off times for each level manually. If you are using a fixed cycle time, such as 300 seconds, enter it here and enter only the **On** time at each level. Default: 0
- **Tunnel Exit Delay (minutes):** Set length of time in minutes before exiting Tunnel mode. This time begins once all other parameters are satisfied.
- **Wind Chill:** Refer to the following section.

#### 4.1.2 WIND CHILL

AC-2000 3G can take into consideration the wind chill factor when making certain calculations related to the temperature. In effect, the wind chill factor acts as the temperature differential. When enabled, AC-

2000 3G determines the “calculated temperature (actual temperature – wind chill temperature) and uses this temperature:

- When calculating the Tunnel Mode level up/down algorithms
- When operating the Cool Pad (if enabled in System Variables; refer to Operate Cool Pad, page 40).

The Wind Chill factor influences controller operation from the 1st tunnel level.

*NOTE The actual temperature: 1) determines the entry and exit into Tunnel Mode 2) controls the fogger.*

Parameters:

- Wind Chill: Enable this parameter to include the wind chill factor in ventilation calculations. Default = No.
- Wind Chill Limit: Maximum wind chill factor value. Default = 8° C.
- RH Effect: The decrease in temperature caused by an increase in relative humidity. Default is 0.26° C.

The Relative Humidity Effect parameter enables including the relative humidity (RH) in the wind chill factor calculations. A rise in relative humidity reduces the wind chill factor. How does it work?

- There is no effect below 40% relative humidity.
- The user determines the increase in temperature for every 5% increase in relative humidity.
  - The default increase is 0.26° C; meaning that between 40.1% - 45% relative humidity, the wind chill factor decreases by 0.26° C. Between 45.1% - 50%, the wind chill factor decreases by 0.52° C, twice the default level. Between 50.1% - 55%, the decrease is 0.78° C, three times the default level, and so on.
  - The user can set the temperature increase as required.
  - To disable this feature, enter '0'

## 4.2 Variable Speed Fan Levels

In the Variable Speed Fan Level table set the speed in percentages for up to two groups of fans by level. Several kinds of speed controllers are supported, such as TRIAC Control and Variable Frequency 3 Phase drives.

VARIABLE SPEED FAN LEVEL			
Level	Tun 2	Exh 2	Exh 3
1	----	30	30
2	----	30	30
3	----	30	45
4	45	45	45
5	45	60	45
6	60	60	60
7	60	75	60
8	75	75	75
9	90	90	90
10	100	90	100

1. In *Install > Analog Output* (refer to Analog Output, page 83), define at least one output as a variable speed fan.
2. In *Device Setting > Levels of Ventilation*, define the mode (required!).



*NOTE* "—" appears when the mode is undefined.

3. In *Device Setting > V. Speed Fan Levels*, define the fans' working percentages.

### 4.3 Vent & Curtain Levels

Set the curtain levels to correspond with the ventilation levels. The operating mode determines the curtain control procedure.

➡ **Before configuring these parameters, define at least two relays as a vent open/vent close, tunnel open/tunnel close, or attic open/attic close. Refer to Relay Layout, page 80.**

VENT & CURTAIN LEVELS			
Level	Attic	Vent	Tunnel
1	0	15	15
2	0	15	15
3	0	15	15
4	0	15	15
5	0	15	15
6	0	15	15
7	0	15	15
8	0	15	15
9	0	15	15
10	0	15	15

*NOTE* Before setting the levels, define the opening mechanism (refer to *Vent/Curtain Setup, page 83*).

1. In *Install > Relay Outlet* (refer to page 80), define at least one relay as Curtain Open, Tunnel Open, Vent Open, or Attic Open.
2. In *Control > Temperature curve*, define the Target Temperature.
3. In *Device Setting > Vent & Curtain Levels*, define the minimum opening percentages.
4. Press **Enter**.
5. If required, configure each opening to work with a particular temperature sensor. Refer to *Temperature Definition, page 85*.
6. Set the Help Set parameters as required.
  - Ventilation Level: Read-only.
  - Tunnel/Curtain/Vent/Attic: Set position for the tunnel curtain by level. If you have Static Pressure in Tunnel turned on ([Control](#) | [Static Pressure](#) | [Help](#) | [Set](#)), this becomes the minimum position for the tunnel inlet.

#### 4.3.1 VENT & CURTAIN LEVELS HELP | SET DEFINITIONS

② While viewing the Vent & Curtain Levels menu: Press **HELP**, select **SET**, and press **ENTER**

SYSTEM PARAMETERS	
<b>CURTAINS</b>	
Stop Fans, Curt. Move (total %)	30
1st Day for 2nd Vent to Oper.	-2
1st Level for 2nd Vent to Oper	1
<b>ATTIC</b>	
Minimum Attic Temp. To Operate	75
Operate Until Day	10
Operate Until Level	10
Operate From Time	0:00
Operate To Time	0:00
Max Temperatur to Disable Attic	100.0

#### Curtains

- **Stop Fans, Curtain Move (total %):** Commands controller to stop fans during curtain movements when total of all curtains is less than the total percent set in this parameter. For example, 3 curtains at 40% each total 120% for this parameter. Default: 30%
- **1<sup>st</sup> Day for 2<sup>nd</sup> Vent to Operate:** Set the day the second vent begins operating. Default: 1.

*NOTE* You can set negative days.

- **1<sup>st</sup> Level for 2<sup>nd</sup> Vent to Operate:** Set the level the second vent begins operating. Default: 1

#### Attic

- **Minimum Attic Temperature To Operate:** Set the minimum temperature to activate the Attic operation.
- **Operate Until Level:** Set the last level for attic operation.
- **Operate From/To Time:** Set the time frame for attic operation.

*NOTE* If one of the above options is relevant, the Attic is enabled.

- **Maximum Temperature to Disable Attic:** Set the maximum attic temperature to stop using attic ventilation. This setting can prevent the heating effect in the growing space being too high resulting in overheating.

## 4.4 Stir Fan Levels

In the Stir Fan Level table set the speed in percentage that you want the variable speed fan to work at (by levels). For each level, program the stir fans' cycle. Configure the actual speed in Analog Output, page 83.

1. Do one or both of the following:
  - In *Install > Relay Outlet* (page 80), define at least one relay as a Stir Fan or
  - In *Install > Analog Output* (page 83) define one function as Variable Stir Fan.
2. In *Device > Stir Fan Levels*, define the parameters as required.
3. Map each stir fan to a temperature sensor (refer to Temperature Definition, page 85) (option).

STIR FAN LEVELS		
Level	Stir Fan No 1 2 3 4 5 6 7	Variable Fan 3 4
1	● ...	◀ ▶ ◊
2	● ...	◀ ▶ ◊
3	● ...	◀ ▶ ◊
4	....	◀ ▶ ◊
5	....	◀ ▶ ◊
6	....	◊ ◊
7	....	◊ ◊

●-Continuous ◀-Cycle On ◊-Cycle Off

NOTE The numbers shown in the screen under Variable Fan depend on how you defined the fans in Installation > Relay Layout and Analog Output.

NOTE  means the level is in tunnel mode.

- **Ventilation Level:** Read only.
- **Variable Fan 1, 2, 3, 4:** Set variable speed fan operation in percentages.
- **Stir Fan:** Control stir fans according to Continuous, Cycle On, Cycle Off (ventilation cycles are the same as previously set in [Levels of Ventilation](#)).



Continuous: Constantly works without a break.



Cycle: Operates according to ON/OFF timer.



Rotate: Operates according to ON/OFF timer; in each cycle a different fan operates

NOTE The Stir Fans operate according to the levels you program in this menu, and according to the programs you select in the Stir Fan Program. The fan turns on if any program or level requests ON; all programs and levels must be OFF for the Stir Fan to be off.

## 4.5 Stir Fan Program

This section contains five different programs that you can assign to each stir fan. Check the programs applying to each fan by using the '+/-' key (further explained in [STIR FAN PROGRAM HELP | SET](#)).

NOTE If the same variable stir fan is selected for different programs, the program having the highest fan speed operates.

NOTE The ~ symbol designates an analog output device.

STIR FAN PROGRAM					
Fan No.	PROGRAM				
	-A-	-B-	-C-	-D-	-E-
1	✓	✓	■	■	■
2~	✓	■	✓	■	✓
3~	■	✓	✓	✓	■
4	■	■	✓	✓	✓
5	■	■	■	■	■
6	■	■	■	■	■
7	■	■	■	■	■
8	■	■	■	■	■

- **A (heaters):** This program corrects temperature variations lengthwise in the building. Insert diff and sensor numbers.
- **B (for min vent):** This program helps mixing minimum ventilation air for buildings having stir fans to mix the air coming in with warm inside air.
- **C, D & E (sensors diff temperature):** These options create three stir fan groups which operate according to sensor differentials.

#### 4.5.1 STIR FAN PROGRAM HELP | SET DEFINITIONS

- ① While viewing the *Stir Fan Program* menu: Press **HELP**, select **SET**, and press **ENTER**

SYSTEM PARAMETERS	
<b>PROGRAM A (for min vent)</b>	
Operate After End of Cycle: ►	ON
Delay for Operation (sec) (+/-)	0
Time for Operation (sec)	0
From Level	0
To Level	0
From Time (hh:mm)	00:00
To Time (hh:mm)	00:00
<b>PROGRAM B (sensors diff temp)</b>	
Temp Diff to Operate	2.0
Diff Between Sensor Number	0
Diff Between Sensor Number	0
Cycle On Time (sec)	0

#### Program A (for Heaters)

- **Diff below Target to Operate:** Set the degree of difference below the target temperature for stir fans to operate.
- **Cycle On time (sec):** Define the length of time in seconds you would like the stir fan to operate during the cycle.
- **Cycle Off time (sec):** Define the length of time in seconds you would like the stir fan to be off during the cycle.
- **From/To Level:** Limit the program to operate between the levels defined.
- **From/To Time:** Define the time frame for the program to operate (24-hour format).
- **Stop During Fan Operation:** Select **YES** run the heaters when the fans are operating.

#### Program B (for Min Vent)

- **Operate after End of Cycle:** Set when stir fan begins operating. It can be at the end of the ON cycle or the OFF cycle set in the [DEVICE | Levels of Ventilation](#).
- **Delay for Operation (sec) (+/-):** Define length of time in seconds from the end or start of cycle you chose in **Operate after end of cycle** above, for the stir fans to operate.
- **Time for Operation (sec):** Define length of time in seconds for the stir fans to operate.
- **From/To Level:** Limit the program to operate between the levels defined.
- **From/To Time:** Define the time frame for the program to operate (24-hour format).

#### Program C, D, E (Sensors Diff Temp or Independent)

- **Temp Diff to Operate:** Set the degree of difference between sensors for stir fans to begin operating.

*NOTE* If this parameter is set to 0 (zero), the variable stir fan runs independently of the sensors.

- **Diff between Sensor Number:** Select a sensor to define one temperature reading.

- **Diff between Sensor Number:** Select a second sensor to define a temperature reading from a different area.
- **Cycle On time (sec):** Define the length of time in seconds you would like the stir fan to operate during the cycle.
- **Cycle Off time (sec):** Define the length of time in seconds you would like the stir fan to be off during the cycle.
- **From/To Level:** Limit the program to operate between the levels defined.
- **From/To Time:** Define the time frame for the program to operate (24-hour format).
- **Stop During Fan Operation:** Select YES run the heaters when the fans are operating.
- **Variable Stir Fan:** Select the stir fan to be used
- **Min/Max Variable Stir Fan Speed:** Enter the minimum and maximum speed (in percentage).

## 4.6 Cool Pad

This menu sets the operating conditions for Cool Pad.

*NOTE Cool Pads only operate when the controller is in tunnel mode. For example, if the cool pad is set to run at Level 8 and the tunnel mode begins at level 10, the cool pad remains inoperative.*

COOL PAD						
Day	Start Time	End Time	Tunnel Diff	To Hum	On sec	Off sec
1	10:00	21:00	3.0	99	15	285
7	10:00	21:00	3.0	99	15	285
7	10:00	21:00	5.0	99	45	255
14	10:00	21:00	2.0	99	15	285
14	10:00	21:00	3.0	99	30	270
14	10:00	21:00	4.0	99	45	255
14	10:00	21:00	5.0	99	60	240
14	10:00	21:00	6.0	99	75	225
14	10:00	21:00	7.0	99	100	200
14	10:00	21:00	8.0	99	200	100

- **Day:** Set growth day.
- **Start Time:** The cool pad begins operating.
- **End Time:** The cool pad ceases to operate.
  - It is possible to set multiple start and stop times for a single day.
  - In the screen above, growth day jumps from day 7 to day 14, the cool pad continues to work according to day 7 settings from growth day 7 through growth day 14.
- **Tunnel Differential:** Set difference from tunnel temperature to use this setting. You can use negative differential temperatures.
  - Note the settings for Day 14. The AC-2000 3G uses the maximum temperature differential that applies to choose the correct settings.
- **To Humidity:** Set maximum humidity allowed before stopping cool pad. You can enter 100%.
- **On Sec:** Set the maximum on time for each cycle of cool pad operation.
- **Off Sec:** Set the minimum off time for each cycle of cool pad operation.

#### 4.6.1 COOL PAD HELP | SET DEFINITIONS

② While viewing the **Cool Pad** menu: Press **HELP**, select **SET**, and press **ENTER**.

SYSTEM PARAMETERS	
<b>COOL PAD</b>	
Temperature Band	2.0
Humidity Band (%)	2
Diff Between Cool Pads Stage	0.0
Cool Pad-1 Min Level	1
Cool Pad-2 Min Level	1
Cool Pad-3 Min Level	1
Cool Pad-4 Min Level	1
<b>COOL PAD FLUSH</b>	
Flush Cool Pad At:	00:00
Cool Pad Flush Duration (minute)	0

### Cool Pad

- **Temperature Band:** Define the on/off hysteresis relative to temperature.
- **Humidity Band (%):** Define the on/off hysteresis relative to humidity.
- **Difference Between Cool Pads Stage:** AC-2000 3G supports four cooling pad stages. The controller activates the first stage when the temperature reaches the Tunnel Temperature (*Control > Temperature Curve*) plus the Tunnel Differentiation (set in the Cool Pad screen). Each additional stage begins when the temperature reaches the Tunnel Temperature plus the Tunnel Differentiation plus this differentiation.

For example, if:

- Tunnel Temperature = 80°
- Tunnel Diff = 2
- Diff between Cool Pads Stage = 3

Stage 1 starts at 82°, Stage 2 at 85°, Stage 3 at 88°, and Stage 4 at 91°.

*Example: Cool Pad ON temperature = 80°, Diff set to 2° F:*

Cool Pad #	Assigned Sensor	Diff Between Cool Pads Stage	Actual ON temperature
1	Average	0.0	80°
2	Average	2.0	82°
3	Temp Sensor 2	0.0	80°
4	Temp Sensor 2	2.0	82°

- **Cool Pad Minimum Level:** In systems having more than one pump, this parameter enables keeping a cool pad inoperative until the associated tunnel curtain turns on. Define the minimum level for each cool pad.

*NOTE When the Difference Between Cool Pads Stage is enabled, the cool pads operate according to both conditions.*

### Cool Pad Flush

- **Flush Cool Pad At:** Set time of day (hh:mm) to start continuous water application to remove deposits from the cool cells.
- **Cool Pad Flush Duration (minutes):** Set the length of time in minutes for flushing. If this parameter is set, flush is applied without regard to ventilation level or operating mode.

## 4.7 Foggers

This menu sets the operating conditions for the Foggers.

- Foggers and Cool Pad have a different temperature reference point. The Fogger Temperature Differentials are relative to the target temperature; the Cool Pad is relative to the tunnel entry temperature.
- Foggers operate even when the controller is not in tunnel mode.

FOGGERS						
Day	Start Time	End Time	Target Diff	To Hum	On sec	Off sec
47	12:00	21:00	18.0	99	300	600
47	12:00	21:00	20.0	99	300	300
0	00:00	00:00	0.0	0	0	0
0	00:00	00:00	0.0	0	0	0
0	00:00	00:00	0.0	0	0	0
0	00:00	00:00	0.0	0	0	0
0	00:00	00:00	0.0	0	0	0
0	00:00	00:00	0.0	0	0	0
0	00:00	00:00	0.0	0	0	0
0	00:00	00:00	0.0	0	0	0

- **Day:** Set growth day
- **Start Time & End Time:** Time of day you want foggers to start and stop.
  - It is possible to set multiple start and stop times for single day.
  - In the screen above, the first programmed line is at day 47. The foggers do not operate before growth day 47 in this case. Since there are no entries other than day 47, the day 47 program lines apply from then on.
- **Target Differential:** Set difference from target temperature to trigger foggers.
- **To Humidity:** Set maximum humidity allowed before stopping foggers.
- **On Sec:** Set the maximum on time for each cycle of fogger operation.
- **Off Sec:** Set the minimum off time for each cycle of fogger operation.

### 4.7.1 FOGGERS HELP | SET DEFINITIONS

- ② While viewing the Foggers menu: Press **HELP**, select **SET**, and press **ENTER**.

SYSTEM PARAMETERS	
FOGGERS	
Temperature Band	2.0
Humidity Band (%)	2.0
Min Level to Enable Operation	1
Max Level to Enable Operation	30
Enable Rotation	NO
Difference between Foggers Stage	0.0

- **Temperature Band:** Define the on/off hysteresis relative to temperature.
- **Humidity Band (%):** Define the on/off hysteresis relative to humidity.
- **Min Level to Enable Operation:** Select the minimum ventilation level to operate the foggers.
- **Max Level to Enable Operation:** Set the maximum ventilation level for fogger operation.
- **Enable Rotation:** Enable this function to use a different fogger relay each cycle. This function enables dispersing the droplets at a higher pressure, to wet the animal.

*NOTE Munters recommends keeping this function set at the default setting (No).*

- **Difference between Foggers Stage:** AC-2000 3G supports four fogging stages. The controller activates the first stage when the temperature reaches the Target Temperature (*Control > Temperature Curve*) plus the foggers differential. Each additional stage begins when the temperature reaches the Target Temperature plus the fogger differentiation.

For example, if:

- Foggers Target Temperature = 80°
- Diff between Foggers Stage = 3
- Stage 1 starts at 83°, Stage 2 at 86°, Stage 3 at 89°, and Stage 4 at 92°.

## 4.8 Light

This menu sets the operating conditions for lights. The controller has a capacity for up to four channels of *On/Off Lights* and up to four channels of *Dimmer Lights*.

LIGHT						
Day	Time	Light			Intensity (%)	
		1	2	3	1	2
1	00:00	✓	✓	■	100	0
12	00:00	✓	■	✓	45	45
12	01:00	■	■	■	0	0
12	03:00	✓	■	✓	45	45
12	21:00	■	■	■	0	0
25	00:00	■	■	■	0	0
25	03:00	■	■	■	35	35
25	20:00	■	■	■	0	0
25	23:00	■	■	■	35	35
0	00:00	■	■	■	0	0

The configuration of this menu is dependent on the (Water and Feed Help | Set Definitions, page 46) configuration:

- If you select Daily, the above screen appears when you select Light; configure the Light menu once. If you select 2 - 6 Days or Week, the screen below appears.



1. Select Feed and press **Enter**. The Light parameters screen appears. These parameters configure the Light functions on feed days.
2. Configure the parameters.
3. Select No Feed and press **Enter**. The Light parameters screen appears. These parameters configure the Light functions on non-feed days.
4. Configure the parameters.
  - Day: Set Growth Day



In the example, the brood lights (channel 1) and bright center lights (channel 2) turn on from day 1, while the grow end lights (channel 3) are off. The example shows two channels of light dimmer, Channel 1 at 100% and Channel 2 at 0% (for baby chicks in the brood zone).

- Time: Set event times for the lights.
  - On day 12, the center lights turn off, and the dimmer lights go to 45%. There are two periods of darkness: from 01:00 to 03:00 in the morning, and 09:00 PM to midnight. This program repeats until day 25.
  - From day 25 the on/off lights stay off, and the dimmer lights provide dim light during the on periods, and go out fully for two periods of darkness. The dark periods total 6 hours, being from midnight to 03:00 AM and from 08:00 PM (20:00) to 11:00 PM (23:00).
- Light: Check mark the desired light(s) you would like to turn on. Apply dots for lights you would like to turn off. Switch between check marks and dots by pressing the +/- key.
- Intensity (%): Set intensity in percentage for light dimmer(s). Dimmer lights start to brighten if the intensity increases, and complete dimming if the intensity decreases at the set time. That is, they start dimming the 'sunset time' in advance of the set time (see **Help | Set** below).

#### 4.8.1 LIGHT HELP | SET DEFINITIONS

② While viewing the Light menu: Press **HELP**, select **SET**, and press **ENTER**.

DEVICE SETTING	
LIGHT	
Sunrise Time (minutes)	10
Sunset Time (minutes)	10
Allow Spiking from Day	1
Spike Cycle (minutes)	0
Spike Duration (minutes)	0
Spike Increase Amount (%)	0
Signal Light Is:	LIGHT2
Signal Before Feed (seconds)	60
Signal During Feed (seconds)	60
Light Sensor Active	NO

- Define:
  - Sunrise Time (minutes): The amount of time required for the light intensity to rise from 0% to the designated level.
  - Sunset Time (minutes): The amount of time required for the light intensity to decline from the designated level to 0%.
  - Allow Spiking from Day: The day spiking begins.
  - Spike Cycle (minutes): The time length that the spike is at its maximum level. Reaching the maximum level and returning to the preset level both take one minute. For example if the spike duration is 10 minutes, the spike cycle is 8 minutes.
  - Spike Durations (minutes): The total amount of time of the spike cycle, including the rise and fall times.
  - Spike Increase Amount: Set the increase in intensity for the spike in relation to the current light intensity.

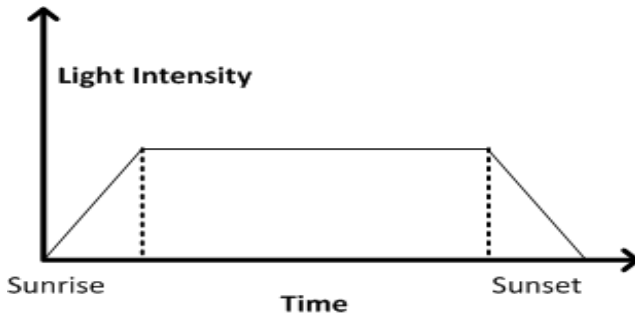

Figure 2: Lighting without Spiking

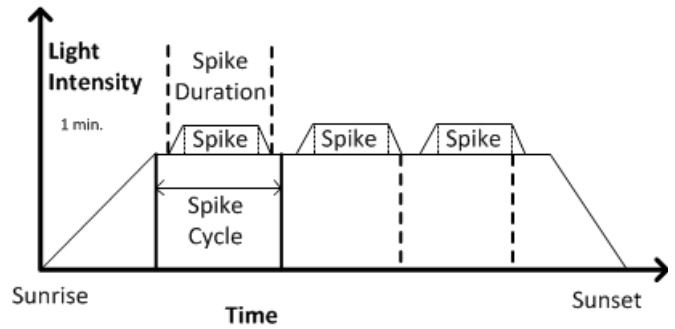

Figure 3: Lighting with Spiking

**NOTE** The initial reference time for the Spike Cycle is the end of Sunrise. The spike begins Spike Duration minutes before the end of the Spike Cycle, and has one minute up and down ramps in intensity. If Sunrise Duration is set to zero, no spiking occurs.

- Signal Light Is: Only one light operates during feeding times. Select which light is lit or choose "None".

**NOTE** After the feeding period ends, all lights selected in the Light Parameters screen relight.

- Signal Before Feed (seconds): Amount of time, before the feeding starts, that all other lights go off.
- Signal During Feed (seconds): Amount of time that the selected light remains on after feeding ends.

**NOTE** The above two parameters are disabled on no feed days.

- Light Sensor Active: The light sensor turns off all lights when sufficient outside lights exists. If a light sensor is installed, enable this option to turn off the light during feeding time when there is sufficient outside light. Refer to Light Sensor Calibration, page XX for details.

## 4.9 Water & Feed

This menu sets the operating conditions for water and feed devices.

WATER & FEED							
Day	Time hh:mm	Water		Feeder		Auger	
		1	2	1	2	1	2
1	00:00	✓	■	✓	■	✓	■
12	10:00	✓	✓	✓	✓	✓	■
25	14:00	✓	✓	✓	✓	■	✓
46	00:00	✓	✓	■	■	■	■
48	00:00	■	■	■	■	■	■
0	00:00	■	■	■	■	■	■
0	00:00	■	■	■	■	■	■
0	00:00	■	■	■	■	■	■
0	00:00	■	■	■	■	■	■
0	00:00	■	■	■	■	■	■

1. Set the parameters as required.

- **Day:** Set growth day. You can define days as negative days. Enter the number and then press the +/-key.

- **Time:** Set event times for water, feeder, or auger. Check marks indicate ON at the event time, and dots indicate OFF. Toggle between check marks and dots with the +/- keys.
- **Water:** Select a check mark to mark water lines to turn on, dot the ones to turn off.
- **Feeder:** Check mark feed lines to turn on, dot the ones to turn off.
- **Auger:** Check mark auger lines to turn on, dot the ones to turn off.

2. Set the Water Overflow Alarms and Water Shortage Alarm (page 54).

*NOTE You can implement mealtime, clean up meals and other options similarly as shown earlier in the light programs.*

#### 4.9.1 WATER AND FEED HELP | SET DEFINITIONS

These parameters define the feed and water delivery schedule through the week.

*NOTE The Water and Feed parameters work in conjunction with the Lighting parameters.*

- **Daily:** Same schedule for every day of the week.
- **2 - 6 Days:** Select a cycle that lasts the number of days chosen and then repeats itself. For example, 2 Days means that the cycle lasts two days and then repeats itself.

SYSTEM PARAMETERS			
WATER & FEEDS		2 DAYS	
Feed Day Cycle			
DAYS CYCLE			
Day:	1	2	
Feed:		√	
WATER ON NO FEED DAYS			
Start	Stop	Start	Stop
10:00	10:30	11:30	12:30

- **Week:** Select which days in the week that feed and water are delivered.

SYSTEM PARAMETERS						
WATER & FEEDS					WEEK	
Feed Day Cycle						
DAYS CYCLE						
Day:	SUN	MON	TUE	WED	THU	FRI SAT
Feed:	√		√	√		√
WATER ON NO FEED DAYS						
Start	Stop	Start	Stop	Start	Stop	
10:00	10:30	11:30	12:30			

*NOTE If you choose Daily, the Scale function is always enabled. If you choose 2- 6 Days or Week, the Scale function is **disabled** on non-feeding days.*

*CAUTION If you want to provide feed every day, select Daily. Selecting Week and marking each day, causes problems with this function.*

If you select the 2 - 6 Day schedule or the Week schedule, configure:

- **Days Cycle (2 - 6 Days):** Select which days in the cycle that feed and water is delivered.
- **Week Cycle:** Select the days that feed and water is delivered.

- **Water on No Feed Days:** Select up to two time periods when water is delivered on non-feed days.

*NOTE On feed days, water is delivered when feed is delivered.*

## 4.10 Extra Systems

This menu sets the parameters of other devices that are not listed in the controller.

EXTRA SYSTEMS				
System	1	2	3	4
Start Time	10:30	06:15	14:20	00:00
End Time	18:45	20:30	03:15	00:00
From Temp	75.5	85.5	60	0.0
To Temp	93.0	95.5	98.0	0.0
From Hum.	55	60	60	0
To Hum.	85	85	85	0
On (sec)	45	45	300	0
Off (sec)	300	300	2000	0

- **Start Time:** Time at which this Extra System starts.
- **End Time:** Time at which this Extra System stops.
- **From Temp:** Temperature above which Extra System operates.
- **To Temp:** Temperature below which Extra System operates.
- **From Humidity:** Humidity above which Extra System operates
- **To Humidity:** Humidity below which Extra System operates.
- **On (sec):** On time for the Extra System. If set to 0, the extra system does not operate.
- **Off (sec):** Off time for Extra System after completion of on time. If you have values in both **ON** and **Off**, the extra system cycles. If you have zero OFF time, and any ON time, the system simply stays on as long as the other parameters are satisfied.

All parameters must be satisfied for an Extra System to operate. If the temperature is below the From Temperature or the Humidity below the From Humidity for example, the system is OFF. You can assign specific temperature sensors to an Extra System in [Install | Temp Definition](#). The Extra System uses the Inside Humidity, not the Outside Humidity. If there is no humidity sensor, the Extra Systems ignore the humidity parameters.

## 4.11 Water on Demand

The Water on Demand (WOD) function enables regulating the pressure of all nipple lines in the house from one central point, ensuring uniform pressure in all lines. The function also enables immediate transitioning between different preset pressures of all nipple lines in the house by closing and opening of valves at the central point (manual or solenoid according to the mode installed).

AC-2000 3G enables controlling the water cycle times using relays and controlling the water pressure using analog input and output sensors. The two methods are complimentary. A user can use either one alone or both.

- Relay Control
- Sensor Control

*NOTE The two methods are complimentary.*

### 4.11.1 RELAY CONTROL

Specify up to 50 time periods.

WATER ON DEMAND			
Day	From Time hh:mm	To Time hh:mm	Relay
1	12:00	14:00	1
2	12:00	14:00	2
3	12:00	14:00	3
5	12:00	14:00	3
7	12:00	14:00	4
9	12:00	14:00	4

1. In *Installation > Relay Layout* designate up to four relays as WOD valves (relays 179 to 182). Refer to page 80 for details.

2. In *Device > Water on Demand*, configure the following parameters:

- **Day:** Specifies the day to activate the selected WOD valve. You can define days as negative days. Enter the number and then press the +/-key.
- **From Time/To Time:** Specifies the time to activate and deactivate the specified WOD valve
- **Relay:** Specifies the WOD valve to be activated

3. Set the Water on Demand Alarms, page 54.

### 4.11.2 SENSOR CONTROL

*NOTE When using sensor control, WOD status appears on the Main Screen, Hot Screen 7, and Hot Screen 0.*

WATER ON DEMAND				
Day	From Time hh:mm	To Time hh:mm	WOD	Press IN. W.C
1	12:00	14:00	1	30.00
2	12:00	14:00	2	20.00
3	12:00	14:00	3	15.00
5	12:00	14:00	3	10.00
7	12:00	14:00	4	10.00
9	12:00	14:00	4	5.00

### To add precision measurements:

1. To control the water valve opening, in *Installation > Analog Output*:
  - a. designate one output device as Water on Demand Precision.
  - b. set the minimum input and output voltages.
2. In *Installation > Analog Sensor*, designate one sensor as **Water of Demand Pre**. This setting enables a sensor to measure the water flow.
3. In *Device > Water on Demand*, configure the following parameters:
  - **Day**: Specifies the day to activate the selected WOD valve. You can define days as negative days. Enter the number and then press the +/-key.
  - **From Time/To Time**: Specifies the time to activate and deactivate the specified required pressure.
  - **Pressure**: Specifies the required water pressure. The unit that appears is the unit defined in *Installation > Setup* (pressure unit) (page 79).
4. In *Device > Water on Demand > Help* set the parameters (optional).
5. In *Service > WOD Calibration*:
  - a. Enter the first pressure and voltage data points.
  - b. Repeat for second data point.
6. Set the WOD alarms in Water on Demand Alarms, page 54.

# 5 Manage Menu

The following sections detail the Management menu.

- Inventory, page 50
- Feed Inventory, 51
- Time & Date, page 51
- Growth Day & Flock, page 52
- Alarm Setting, page 52
- Alarm Reset, page 56
- Password, page 56

MANAGEMENT			
1. BIRD INVENTORY			
2. FEED INVENTORY			
3. TIME & DATE			
4. GROWTH DAY & FLOCK			
5. ALARM SETTING			
6. ALARM RESET			
7. PASSWORD			
8. RELAY CURRENT			

## 5.1 Inventory

Maintain your inventory by entering data into the controller.

BIRD INVENTORY			
	Male	Female	Total
Add Dead Birds	0	0	0
Add Culled	0	0	0
Birds Moved	0	0	0
Birds Placed	10000	5000	15000
Today's Dead Birds	35	33	68
Today's Culled	12	10	22
Total Dead Birds	35	33	68
Total Culled	12	10	22
Total Birds Moved	1020	510	1530
Bird Count	8933	4447	13380

- Maintain inventory by entering quantities in the upper half of the screen. There are separate columns for male and female. If you do not wish to keep separate data, simply enter the data into one or the other.
- Initially, enter the number of birds/animals **placed**. Thereafter, enter the quantity found **dead**, **culled** (Add Culled) or **moved** as needed. The AC-2000 3G shows totals and subtotals in the lower portion of the screen.
- You can correct an error, so long as you correct it on the same day before midnight, by entering a negative quantity (press the +/- key after the number) to subtract the error. After midnight, the information transfers to the [History](#) Menu.

## 5.2 Feed Inventory

Maintain your feed inventory by entering data into the controller.

FEED INVENTORY					
No.	Date	1	2	3	4
1	2-Jan-08	7800	0	0	0
2	5-Jan-08	0	9000	15000	10000
3	13-Jan-08	8000	0	0	0
4	- -	0	0	0	0
5	- -	0	0	0	0
6	- -	0	0	0	0
7	- -	0	0	0	0
8	- -	0	0	0	0
<b>Total Feed:</b>		<b>15800</b>	<b>9000</b>	<b>15000</b>	<b>10000</b>
<b>ACTIVE</b>		√	√	√	√

To enter feed inventory manually:

1. Type the day of the month and press **ENTER**.
2. Select the month and press **ENTER**.
3. Type the two-digit year and press **ENTER**.
4. Enter the feed quantity under the Feed Bins and press **ENTER**. The cumulative total appears in the **Total Feed** row.
5. To delete an entry, change the quantity to zero for all feed bins and press **ENTER**. Exit the menu and the entry disappears when you enter the menu again.

You can monitor your fill system and maintain approximate feed inventory using the [Digital Inputs](#). In this case, you need to enter your own delivery dates.

This information is transferred to the [History | Water & Feed](#) menus daily, or optionally as often as selected (by the minute) in [History View](#).

### 5.2.1 FEED INVENTORY HELP | SET DEFINITIONS

- ② While viewing the **Feed Inventory** menu: Press **HELP**, select **SET**, and press **ENTER**.

SYSTEM PARAMETERS	
<b>FEED INVENTORY</b>	
Total Feed In Silo-1	0
Total Feed In Silo-2	0
Active Silo	SILO-1

- **Total Feed in Silo-1/ -2:** Manually change or correct the amount of feed in the bins.
- **Active Silo:** Select the desired feed bin for use. It is possible to select both.

## 5.3 Time & Date

This menu sets the current time and date for the controller.

TIME & DATE	
Current Time	09:19
Date	10-Mar-08
Day of the Week	SUNDAY



- **Current Time:** Enter the current time in 24 hour format.
- **Date:** Enter the date in day-month-year format.
- **Day of the Week:** Select the day of the week from the drop down menu.

## 5.4 Growth Day & Flock

This menu defines the number of growth days and flock number.

Growth Day & Flock	
Current Growth Day	27
Flock No.	1
New Flock	NO

- **Current Growth Day:** Enter current growth day, if necessary. It is possible to enter negative growth days up to -7. If you reset the growth day for a new flock using this tool, your old history data does not clear. Use New Flock function to clear out old history in preparation for new birds.
- **Flock No.:** The controller automatically increments the flock number each time you choose New Flock. You can edit the flock number. Since this field accepts six digits, some producers enter a flock number that is made of the day, month and year the birds arrived.
- **New Flock:** Use the new flock function on arrival of a new set of birds to set the growth day back to 1, 0, -1, or down to -7, and to clear out old history data.

## 5.5 Alarm Setting

This menu defines the various alarm settings.

ALARM SETTING	
Global Alarm Delay (sec)	1
Alarm Reminder (min., 0-Disable)	30
<b>SENSOR ALARM</b>	
Sensor Low Temp. Range	32.0
Sensor High Temp. Range	122.0
Sensor Alarm-Diff From Lo. Alarm	1.0
Sensor Alarm-Diff From Hi. Alarm	1.0
<b>ALARM</b>	
Alarm Test At Time: (hh:mm)	12:00
Day Of Alarm Test: ▶	DAILY
Alarm Test Duration (sec)	0
<b>AUGER OVERTIME ALARM</b>	
Auger Overtime Delay (minute)	15

- **Global Alarm Delay (sec):** Alarms without a separate alarm delay, use this global delay before signaling the alarm.
- **Alarm Reminder (min., 0-Disable):** Set a reminder after a period of time in minutes if the situation has not yet been corrected.

### Sensor Alarm

- **Sensor Low Temperature Range:** Sets the minimum reading a sensor can have to be considered a valid sensor reading. Sensor readings below this are rejected. This generates a sensor out of range alarm. This does not apply to the special Circuit Breaker Sensor or Outside Temperature Sensor.
- **Sensor High Temperature Range:** Sets the maximum reading a sensor may have to be considered a valid sensor reading. Sensor readings above this reading are rejected. This

generates a sensor out of range alarm. This does not apply to the special Circuit Breaker Sensor or Outside Temperature Sensor.

- **Sensor Alarm-Differential from Low Alarm:** Individual sensor (or zone) alarm if any active sensor reads this much or more below the [Control | Temperature Curve | Low Alarm Temperature](#).
- **Sensor Alarm-Differential from High Alarm:** Individual active growth area sensors alarm if they read this much or more above the [Control | Temperature Curve | High Alarm Temperature](#).

## Alarm

- **Alarm Test at Time:** Schedule an alarm test at a particular time.
- **Day of Alarm Test:** Choose **Daily** or a particular **day** of the week for the scheduled alarm.
- **Alarm Test Duration (sec):** Choose a specific duration for the Alarm Test.

## Auger Overtime Alarm

- **Auger Overtime Delay:** Set the maximum auger run time for your cross fill system. If you have a monitor connected to the digital inputs programmed as Feeder-1 Overtime or Feeder-2 Overtime the AC-2000 3G sends an alarm after this delay.
- **Feeder Off During Overtime:** Choose whether to shut the feed systems off after a feeder overtime alarm. Options:
  - **No:** All augers and feeders remain on.
  - **All:** All augers and feeders shut down.
  - **Related:** Only the specific auger from which the alarm originated and its feeders shut down.

*NOTE* If you choose **All** or **Related**, the feed system turns off and does not resume until you [Reset Alarm](#) in the Management Menu.

## Feeder Overtime Alarm

- **Feeder Overtime Delay:** Set the maximum feeder run time for your cross fill system. If you have a monitor connected to the digital inputs programmed as Feeder-1 Overtime or Feeder-2 Overtime the controller sends an alarm after this delay.
- **Feeder Off During Overtime:** Choose whether to shut the feed systems off after a feeder overtime alarm. Options:
  - **No:** All augers and feeders remain on
  - **All:** All augers and feeders shut down.
  - **Related:** Only the specific auger from which the alarm originated and its feeders shut down.

*NOTE* This alarm functions in the Broiler mode only.

*NOTE* Setting the Feeder Off During Overtime to All in either the Auger Overtime Alarm or the Feeder Overtime Alarm shuts down the augers and feeders, regardless of the other alarm's setting.

## Auger Empty Alarm

- **Condition Detection Delay (sec.):** AC-2000 3G sends an alarm when the current goes to the level set in the following parameter after this delay.

### 5.5.1 ALARM SETTING HELP | SET DEFINITIONS

- ② While viewing the Alarm Setting menu: Press **HELP**, select **SET**, and press **ENTER**

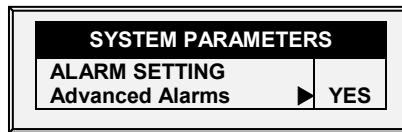

- **Advanced Alarms:** When selecting YES, the following additional alarms appear on the ALARM SETTINGS screen (press MENU and then ENTER to reenter the screen).

#### Water on Demand Alarms

- **High/Low Pressure Diff (PSI):** Sends an alarm when the difference between the current WOD pressure and the defined pressure reaches these levels. 0 means that the alarm is disabled.
- **Shutdown Pressure Diff (PSI):** Shuts down the Water on Demand system when the pressure reaches this level.
  - Shutdown pressure must be equal to or higher than the High/Low Pressure Difference.
  - However, to disable this alarm set it to 0 (zero), even if the High/Low Pressure is above 0.

#### Feed Alarms

- **Allow Feed Alarm From/To:** Set a starting time from which the controller can send feed shortage alarms.
- **Bin 1/2 Low Feed Alarm Limit:** Alarm if feed in Bin 1/2 is below this limit and time is between From and To limits.
- **Feed Alarm Limit (per hour):** An alarm is generated if the feed flow is greater than this amount. This alarm is activated when a problem arises inside the barn (as opposed to when something happens to the feed scale).

#### Water Overflow Alarms

- **According to Light Table:** Change overflow alarm level when the lights are off.
- **First Day:** Overflow on the FIRST day applies to the first day operation. You can define a first day at which to start increasing the overflow limit automatically. Days prior to the 'First Day' use the First Day overflow limit; days following the first day have an incremental curve toward the LAST DAY OVERFLOW parameter setting.
- **Overflow on First Day:** Number of gallons/liters per minute that generate an overflow alarm on the first day.
- **Last Day:** Set the last day for the Overflow curve.
- **Overflow on Last Day:** Overflow (Gallons/Liters) on the last day sets the maximum overflow limit will be continued after that day.
- **Overflow At Dark:** Select overflow limit. When it is dark, controller checks every minute.
- **Overflow Alarm Delay:** Define delay time before the controller generates an overflow alarm.
- **Extra Delay At Light Start:** When the first light appears, define the amount of minutes before the controller begins to operate according to the set Overflow for that day.
- **Fogger Water Overflow:** Define the water overflow for foggers (per minute).

#### Water Shortage Alarms

- **Allow Water Shortage Alarm From/To:** Set the period for which the controller generates water shortage alarms.

- **Shortage During Lights Off:** Select whether water shortage alarm should be disabled when all lights are out.
- **Quantity for Shortage:** Minimum flow rate that must be maintained or a water shortage alarm is generated.
- **Shortage Alarm Delay:** Minimum period of time that the shortage must extend through before generating an alarm.
- **Shortage Start Day:** Define on what day shortage alarms begin. This parameter prevents false alarms caused by young birds low water usage. Default: 0 (meaning alarms function normally throughout the growth cycle).

### Bird Scales Alarms

- **Allow Bird Scale Alarms From/To:** Set time frame for which the controller begins and ends generating alarms for the bird scale.

### Auxiliary Alarms

- Assign auxiliary alarms in the Install menu. Note that digital sensors, auxiliary alarm input with related relay must always match their relay status.
- Related Relay For Aux Alarm 1/2/3/4: Relay for Auxiliary Alarm 1/2/3/4.
- **AUX. Alarm Delay (sec):** Separate from the **Global Alarm Delay**. If there is a dry contact, the alarm is sent after the defined **AUX. Alarm Delay**.

### Circuit Breaker Alarm

- **Temperature for Circuit Breaker Alarm:** Set circuit breaker alarm temperature.

### CO2 Sensor Alarm

- **CO2 High Level:** Set the maximum allowed CO2 level above which an alarm is sent. The alarm ceases when the CO2 drops below this level. If the user acknowledges the alarm, the alarm messages temporarily cease (for the reminder time).

### Humidity Sensor Alarm

- **Humidity Alarm Enabled:** Mark this parameter as Yes to enable the Humidity High Level alarm and the Humidity Sensor Fail alarm.
- **Humidity High Level Alarm:** Set the maximum allowed humidity level above which an alarm is sent. The alarm ceases when the humidity drops below this level. If the user acknowledges the alarm, the alarm messages temporarily cease (for the reminder time).

### Ammonia Alarm

- **Ammonia High Level:** Set the ammonia level at which an alarm is sent.

### Potentiometer Alarm

- Enable potentiometer alarms, which send an alarm when potentiometer controlled devices fail. To enable, sent the time frame. If the from/to times are set to 0:00 (default) the alarm is disabled.

## 5.6 Alarm Reset

This menu functions as an alarm and siren reset.

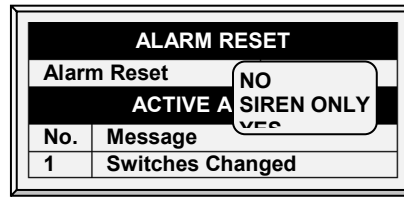

- Alarm Reset:
  - **NO:** Does not reset alarms
  - **SIREN ONLY:** Resets only the siren, alarms remain
  - **YES:** Resets alarms

Selecting **YES:**

- Clears the alarm relay for all current alarms. The alarms may remain valid, but the unit does not register new alarms. If a new alarm occurs, or an existing alarm clears and reoccurs, the alarm relay signals again (after any appropriate delay).
- Restores normal operation after an emergency pressure or feed overrun incident. If the controller experiences a high-pressure alarm for too long, it enters emergency pressure operation by opening all known air sources. Curtains open to preset amounts as set in Control | Static Pressure. If you select SIREN ONLY, the alarm relay returns to the no alarm condition, but the emergency pressure status continues.
- Restores normal operation after a feed overrun situation that calls for turning off the feeding system. If the feed monitor senses the cross auger runs too long, it trips a feed overrun alarm and optionally turns off the feed system. If you select SIREN ONLY, the alarm relay returns to the no alarm condition, but the feed overrun status continues.

## 5.7 Password

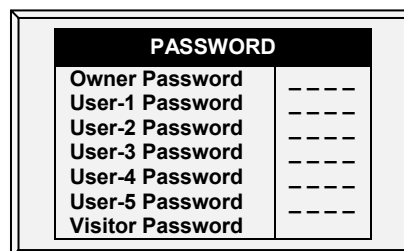

The owner can set new passwords for himself, all users and the Visitor. The owner cannot see user passwords once entered or changed by the users. The users can access the controller and make changes to all controller settings and their own password. A user can only see and change his own password. The visitor can access the controller, but cannot make changes. Each time someone accesses the controller with a password, an event is recorded in the [History | Table of Events](#).

If your controller uses passwords, the controller also requires a password entry to acknowledge switch position changes. If the switch change is not acknowledged the controller signals an alarm.

# 6 Scale Menu

The following sections detail the weighing functions.

- Scale Layout, page 57
- General Settings, page 57
- Bird Scale Setting, page 58
- Bird Curve/Bird Weight, page 59
- History, page 61
- Feed Conversion, page 63
- Test, page 63
- Calibration, page 63

SCALE	
1.	SCALE LAYOUT
2.	GENERAL SETTINGS
3.	BIRD SCALE SETTING
4.	BIRD CURVE
5.	HISTORY
6.	FEED CONVERSION
7.	TEST
8.	CALIBRATION

## 6.1 Scale Layout

Use Scale Layout to map the scales connected to the controller.

SCALE LAYOUT	
Ch.	Type
1	Scale 1
2	Scale 2

This screen does not require user input.

## 6.2 General Settings

This menu sets general weighing parameters.

*NOTE This function does not appear in Version 9.19 and above.*

GENERAL SETTINGS	
Bird Scale Mode	SEXED
Uniformity Range (5-30%)	10
Curve Selector (for mixed)	BROILER
Weigh During Feed Days	NO

- **Bird Scale Mode:** Select the weighing method:
  - **SEXED:** Considers all birds to be the same sex or 'unisex' as in mixed broilers. It computes its own reference weight or acceptable range from the weighed birds.

- **MIXED:** Considers the flock to be mixed males and females, with the goal of identifying each bird weight as male or female, which is, classifying it according to a pre-programmed pair of expected weight curves.
- **Uniformity Range (5-30%):** Controller classifies bird weights within this percentage of the average as uniform. Default is 10%.
- **Curve Selector (for mixed):** There are three standard pairs of pre-programmed weight curves. If you use the mixed weighing method, edit the curves to match your expected growth profile (**BROILER, TURKEY, or BREEDER**).
- **Weigh During Feed Days:** Allow weight data to be recorded on feed days. When set to NO, this data is discarded. Default: No

### 6.2.1 GENERAL SETTINGS HELP | SET DEFINITIONS

② While viewing the **General Settings** menu: Press **HELP**, select **SET**, and press **ENTER**

BIRD CURVE	
Factory Default Curve	N o

- **Factory Default Curve:** Select **YES** to return bird curves to the factory default settings

## 6.3 Bird Scale Setting

Define at least one scale, silo, or feed scale in Scale Layout.

- Bird Scale Setting, Version 9.18 and Below
- Bird Scale Setting, Version 9.19

### 6.3.1 BIRD SCALE SETTING, VERSION 9.18 AND BELOW

There are two different weighing options available; select the option in *Scale > General Settings*.

BIRD SCALE SETTING - SEXED	
Start Time	18:00
End Time	19:00
Upper Range (Above Reference %)	30
Lower Range (Below Reference %)	2
Reference Weight 1	0.13
Reference Weight 2	0.11

BIRD SCALE SETTING - MIXED	
Start Time	18:00
End Time	19:00
Male Range	
Upper (Above Reference %)	20
Lower (Below Reference %)	10
Female Range	
Upper (Above Reference %)	20
Lower (Below Reference %)	10

- **Start Time:** Set the hour you would like the scale to begin weighing
- **End Time:** Set the hour you would like the scale to stop weighing
- **Range - (0-100%):** Band above and below reference weight
- **Reference Weight 1:** Starting out weight for Scale 1
- **Reference Weight 2:** Starting out weight for Scale 2

## 6.3.2 BIRD SCALE SETTING, VERSION 9.19

- Bird Scale Setting Screen
- Bird Scale Setting | Set Definitions

### 6.3.2.1 Bird Scale Setting Screen

In this screen, select the algorithm used to calculate the bird curve that appears in Bird Weight, Version 9.19. There are three options:

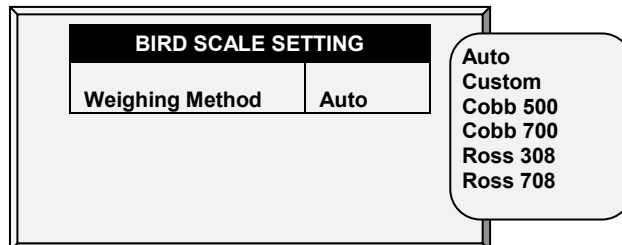

- **Auto:** Set the first target weight. The controller then automatically calculates each days reference weight.
- **Custom:** The controller provides a weight vs growth day curve, which the user can edit as required.
- **Factory Default Curve:** The controller loads an industry standard bird curve. This curve cannot be edited.

### 6.3.2.2 Bird Scale Setting | Set Definitions

② While viewing the Bird Scale Setting menu: Press *HELP*, select *SET*, and press *ENTER*.

BIRD SCALE SETTING	
Upper Range [%]	25
Lower Range [%]	25

- The upper/lower range parameters defines the range of weights that are recorded. The weights of birds that exceed differ from the bird curve by these amounts are discarded.

## 6.4 Bird Curve/Bird Weight

- Bird Curve, Version 9.18 and Below
- Bird Weight, Version 9.19



### 6.4.1 BIRD CURVE, VERSION 9.18 AND BELOW

This screen displays data according to growth day for **broilers, turkeys, or breeders**, previously set in General Settings.

BIRD CURVE		
Day	Female Weight	Male Weight
1	0.11	0.13
7	0.31	0.35
14	0.66	0.70
21	1.26	1.54
28	2.07	2.73
35	3.15	4.27
42	4.45	6.15
49	5.95	8.22
Now	1.87	2.44

Edit the growth days and weights for the bird curves to fit individual preference.

#### 6.4.1.1 Bird Curve Help | Set Definitions

② While viewing the **Bird Curve** menu: Press **HELP**, select **SET** and press **ENTER**.

BIRD CURVE	
Bird Curve Offset	0.2

**Bird Curve Offset:** Enter the factor used to adjust the weight curve. This amount is added to the "Now" field. Range: 0.0 - 10.0 Kg/Lb.

### 6.4.2 BIRD WEIGHT, VERSION 9.19

This screen displays the expected bird weight according to growth day. Which screen is displayed is dependent on the curve selected in Bird Scale Setting, Version 9.19 (page 59).

- Bird Weight Screens
- Bird Weight Help | Set Definitions

#### 6.4.2.1 Bird Weight Screens

- Auto Method

BIRD WEIGHT AUTO METHOD	
Current Weight	1.00

- If you selected Auto in Bird Scale Setting, the Bird Weight screen displays the target weight for the current growth day. You can edit the weight as required.
- Custom Weight

CUSTOM CURVE	
Day	Weight
0	0.00
1	0.00
2	0.00
3	0.00
4	0.00
5	0.00

- If you selected Custom in Bird Scale Setting: **Edit the weights as required.**
- Factory Default Curve

WEIGHT CURVE	
Day	Weight
0	0.09
1	0.13
2	0.16
3	0.20
4	0.24
5	0.30

- If you selected a Cobb or Robb Curve in Bird Scale Setting, the Bird Weight screen displays each day's target weight using an industry standard. **These data points are read-only.**

#### 6.4.2.2 Bird Weight Help | Set Definitions

② While viewing the **Bird Weight** menu: Press **HELP**, select **SET** and press **ENTER**.

*NOTE* Auto method does not feature a help screen.

BIRD WEIGHT	
Curve Offset	0.00

- **Curve Offset:** Enter the factor used to adjust the curve. This amount is added to the "Now" field. Range: -2.000 - 2.000 Kg / -4.40 - 4.41 lb.

## 6.5 History

The scale history shows bird weight statistics. You can review daily data for each scale, or separately.

- History, Version 9.18 and Below
- History, Version 9.19

### 6.5.1 HISTORY, VERSION 9.18 AND BELOW

- In Version 9.17 and below, the unit records the data of up to two-bird scales; if you have more than one scale-1, data is combined.
- In Version 9.18, the controller records up to four scales.

*NOTE* Only Broilers/Layers Mode supports this function

HISTORY					
Day	Avg.	NO.	S.D.	Unif.	C.V
17	0.000	0	0.000	0	0
18	0.000	0	0.000	0	0
19	0.000	0	0.000	0	0
20	0.000	0	0.000	0	0
21	0.000	0	0.000	0	0
22	0.000	0	0.000	0	0
23	0.000	0	0.000	0	0
24	0.159	1	0.000	100	0
25	0.000	0	0.000	0	0
26	0.000	0	0.000	0	0

Figure 4: Version 9.17 or below

HISTORY									
Day	Avg.	Scale1	Scale2	Scale3	Scale4	NO.	S.D.	Unif.	C.V
17	0.000	0.000	0.000	0.000	0.000	0	0.000	0	0
18	0.000	0.000	0.000	0.000	0.000	0	0.000	0	0
19	0.000	0.000	0.000	0.000	0.000	0	0.000	0	0
20	0.000	0.000	0.000	0.000	0.000	0	0.000	0	0
21	0.000	0.000	0.000	0.000	0.000	0	0.000	0	0
22	0.000	0.000	0.000	0.000	0.000	0	0.000	0	0
23	0.000	0.000	0.000	0.000	0.000	0	0.000	0	0
24	0.159	0.000	0.000	0.000	0.000	1	0.000	100	0
25	0.000	0.000	0.000	0.000	0.000	0	0.000	0	0
26	0.000	0.000	0.000	0.000	0.000	0	0.000	0	0

Figure 5: Version 9.18

- If you selected **SEXED** weighing, the history includes average data for the combined scales, and on the next screens separate data for each scale.
- If you select **MIXED** weighing, the history includes average data for all birds, and separate male and female data for Scale 1 and for Scale 2.
  - Use the arrow keys to scroll to the separated scale data, or up and down for data that is off screen.
  - The average and the number of weights are the usual definition. The Standard Deviation is the usual biased estimator (see a suitable textbook on statistical measurements). The Uniformity is the industry standard 10% uniformity (number of birds per 100 within 10% of the average weight), and the Coefficient of Variation or C.V. is the normalized standard deviation (standard deviation divided by average times 100 %.)

### 6.5.2 HISTORY, VERSION 9.19

HISTORY									
Day	Avg.	D.Gain	Unif.	No.	Scale1	D.Gain	Unif.	No.	
1	0.00	0.00	0.00	0.00	0.00		0.00	0.00	
2	0.00	0.00	0.00	0.00	0.00		0.00	0.00	
3	0.00	0.00	0.00	0.00	0.00		0.00	0.00	

- The D. Gain shows difference between the current average weight and the previous day's average weight; the data comes from all the scales.
- No daily gain is shown for individual scales.

## 6.6 Feed Conversion

This screen displays the amount of feed converted into the bird's weight.

FEED CONVERSION			
Day	Bird Weight	Daily Feed	Feed Conversion
17	0.00	0	N/A
18	0.00	0	N/A

## 6.7 Test

This section is a real time table to show the statuses of all scales connected to the controller.

1. In *Scale > Scale Layout* (refer to page 57), select the required scale types.
2. In *Scale > Test*, test the scales as required.

TEST				
	- 1 -	- 2 -	- 3 -	- 4 -
Type	Scale-1	Scale 2	Scale 3	Scale 4
A/D	2024	2010	1891	1893
Weight	0.222	35.768	0.000	0.000
Status	O.K.	O.K.	O.K.	O.K.

Make sure that all statuses are **O.K.** If any of them show a different status, the scale is not installed properly. Unused positions can also show **O.K.**

## 6.8 Calibration

This menu calibrates the scales connected to the controller.

1. In *Scale > Scale Layout* (refer to page 57), select the required scale types.
2. In *Scale > Calibration*, calibrate the scales.

**CAUTION** Do not use scales while calibrating.

3. Follow instructions on the bottom section of the screen.
4. Wait until the progress bar displayed shows 100%.
5. Place a known weight on the scale and enter its weight.
6. Wait until the calibration progress bar reaches 100%.
7. Ensure "Good Calibration."

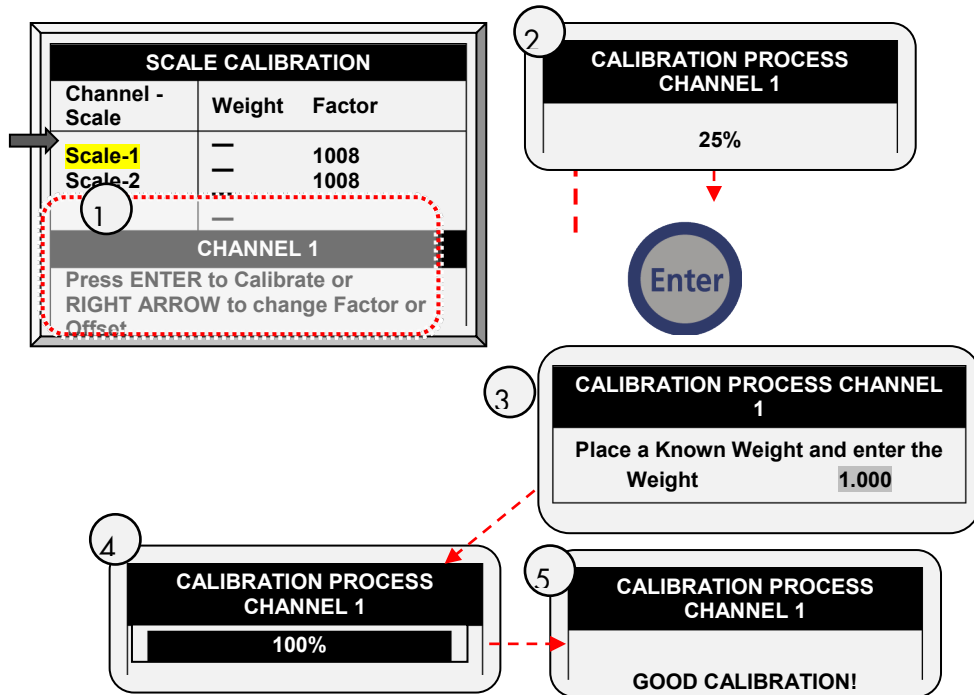

# 7 History Menu

In the History Menu you can view data regarding:

- Temperature
- Humidity
- CO2
- Water
- Feed
- Mortality
- Heaters
- Radiant Heaters
- Alarms
- Table of Events
- History View



## 7.1 Temperature

The temperature history menu stores minimum, average and maximum temperatures by growth day. The average is weighted, so if most of the day has been warm the average is closer to the maximum than the minimum.

## 7.2 Humidity

The humidity history menu stores minimum, average and maximum inside humidity by growth day. The average is weighted, so if most of the day has been humid the average is closer to the maximum than the minimum.

## 7.3 CO2

The CO2 history menu stores minimum, average and maximum inside CO2 levels by growth day. The average is weighed, therefore if most of the day has been high CO2 levels the average is closer to the maximum than the minimum.

## 7.4 Water

The water menu records daily water consumption and shows the daily differential change from the previous day in percent. You must have the water monitor digital inputs connected. You can monitor up to two drinking water meters, total drinking water, total water, cool pad, fogger and cold pad flush consumption.

As an option, the user can monitor the water per bird.

1. Go to History > Water > Help.
2. Enable Display History Per Bird.

WATER			
Day	Water P.bird	Water-1	Water-2
1	0.0 (%)	0.0 (%)	0.0 (%)

The screen displays the amount and the percentage change.

## 7.5 Feed

The feed menu records daily feed consumption and shows the daily differential change from the previous day in percent for two feed bins/fill systems. You must have a feed bin weighing system installed for the feed system, or monitor the auger system.

The feed data can be based on one of the following inputs. If more than one input is installed, priority is according to the order of the bulleted list.

- **Feed Bin:** If feed bins (load cells) are installed, feed consumption data of each bin is based on the feed bin weight.
- **Feed Count:** If a feed count sensor is installed feed consumption for each feed count input is based on the feed count method settings (refer to Digital Sensors, page 82).

As an option, the user can monitor the feed per bird.

1. Go to History > Water > Help.
2. Enable Display History Per Bird.

WATER			
Day	Feed P.Bird Daily	Feed-1 Daily	Feed-2 Daily
1	0.0 (%)	0.0 (%)	0.0 (%)

## 7.6 Mortality

The mortality history menu maintains daily summaries of mortality, cull and total dead. It also shows the percentage dead and gives an updated count of bird inventory. The history is maintained separately for male, female and total. Use the left and right arrow keys to switch to the next screen.

## 7.7 Heaters

The AC-2000 3G maintains daily total run times of each heater. The table fills several screens; to view the off screen data, use the arrow keys to scroll. The data is in hours: minutes format.

## 7.8 Radiant Heaters

The AC-2000 3G maintains daily total run times of each radiant heater, including separate data for low level and high-level heaters. The table fills several screens; to view the off screen data, use the arrow keys to scroll. The data is in hours: minutes format.

## 7.9 Alarms

The alarm history records the growth day and time of each alarm. Alarms that are currently active show up as flashing on the screen. Alarm history is not reset when using *Management, Growth Date & Flock > New Flock*. The last 250 alarms are saved, and as the table is filled, new alarms push out the older alarms.

## 7.10 Table of Events

The AC-2000 3G records significant events with growth day and time stamp. The Table of Events is 1000 events long and is not reset when using *Management, Growth Date & Flock > New Flock*. New events push out the older events.

Typical events recorded are switch changes, entry into tunnel mode, minimum ventilation, alarm resets, ventilation mode changes and more. The Table of Events is an excellent tool to determine whether your controller is going in and out of tunnel due to marginal settings as well as finding and identifying problems

Go to the Table 4, page 105 to view all the available events.

## 7.11 History View

The History View menu has detailed history on a variety of sensors and data.

1. Go to *Help > Set* under History View to select the particular data to collect.
  2. Go to *Install > Setup > History Resolution* to set the frequency of your data collection. You can collect data as frequently as by the minute or only on a daily basis. Factory default collects one-hour data on a selection from the choices below.
- Under **Help | Graph** you can select a variety of graphs of the detailed history.
  - In the **HISTORY VIEW | HELP | SET** menu, set the desired choice by using the '+/-'.

The options are as follows:

- Target Temp.
- House Temperature: Minimum, Average and Maximum
- Temp - 1-6: Minimum, Average and Maximum
- Attic Sensor: Minimum, Average and Maximum
- Outside Temperature: Minimum, Average and Maximum
- Humidity In/Out: Minimum, Average and Maximum
- Water Consumption
- Feed Consumption
- Level of Ventilation

Altering choices erases old data and starts a fresh data set.



# 8 Test Menu

The Test Menu screen shows internal information in order to verify that the AC-2000 3G is operating correctly. Moreover, it can help find broken wires or any other problems related to it.

- Relays, page 68
- Alarm, page 68
- Analog Sensors, page 69
- Digital Sensors, page 69
- Analog Output, page 69
- Static Pressure, page 70
- Communication, page 70

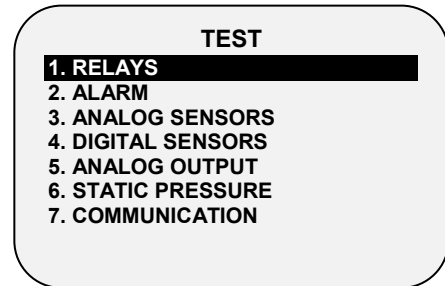

## 8.1 Relays

This menu displays a screen of identified relays installed in the controller. Use this option to determine faulty hardware. If a relay is active, the relay number has a black background.

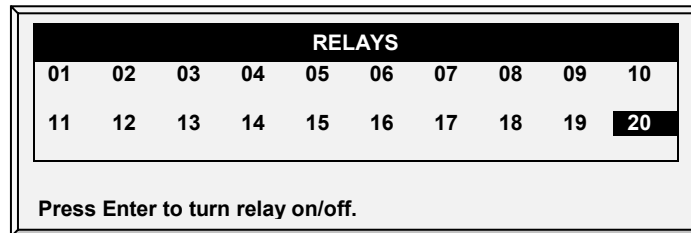

## 8.2 Alarm

Press **Enter** to toggle the Alarm Relay.

- ON means alarms are functioning.
- OFF means alarms are not functioning.

Note that the alarm relay is powered for the 'NO ALARM' condition to automatically provide **Power Fail Alarm** in case of a power failure. That is, the Normally Open side is closed during NO ALARM.

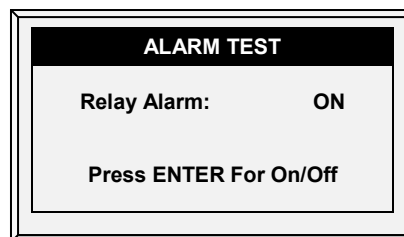

### 8.3 Analog Sensors

Observe the converter readings for analog sensors with this menu.

➡ Define the sensors in Installation > Analog Sensors.

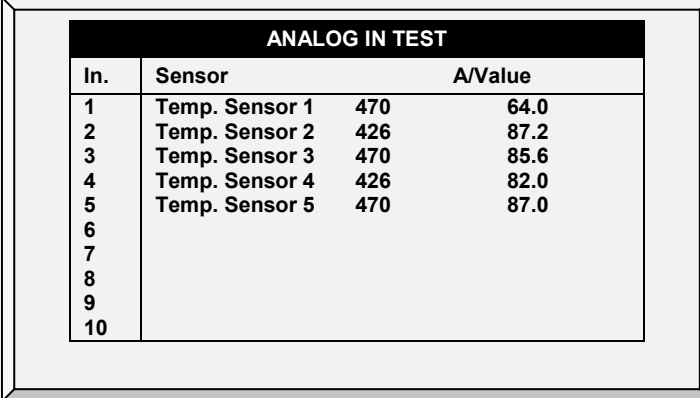

ANALOG IN TEST			
In.	Sensor	A/Value	A/Value
1	Temp. Sensor 1	470	64.0
2	Temp. Sensor 2	426	87.2
3	Temp. Sensor 3	470	85.6
4	Temp. Sensor 4	426	82.0
5	Temp. Sensor 5	470	87.0
6			
7			
8			
9			
10			

The readings can vary from 0 to 1023.

The values displayed in the 'Value' column indicate that the analog sensor is either operating or not connected according to the following:

- The value is in the range 0-1023. If the number is 1023 (or very close to it) the sensor is not connected.
- If the unit displays a 3-digit number, usually beginning with the digit '4': sensor is **operating**.

### 8.4 Digital Sensors

➡ Define the sensors in Installation > Digital Sensors.

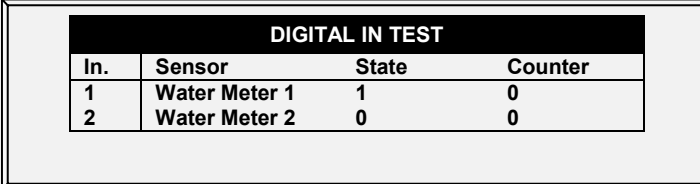

DIGITAL IN TEST			
In.	Sensor	State	Counter
1	Water Meter 1	1	0
2	Water Meter 2	0	0

Observe the state of the two digital sensors. A '1' indication implies a shorted input, a '0' an open input. The digital sensors operate with dry contact inputs such as the Arad Water Meter, or micro-switches.

You can apply a short/open input to each channel; the response is then displayed.

### 8.5 Analog Output

This selection tests light dimmers, variable speed fans, and variable heaters.

➡ Define the sensors in Installation > Analog Output.

1. Scroll to the required output.
2. Enter the test voltage and verify that the device is operating.

ANAGLO OUT TEST		
Output.	Sensor	0 – 10v
1	Light Dimmer 1	0.0
2	Light Dimmer 2	0.0

## 8.6 Static Pressure

Observe the converter readings for the static pressure sensor. The nominal 'zero' pressure reading is 130. Remove the air hoses from the brass connectors on the left side outside of the controller to check this reading.

STATIC PRESSURE	
A/D Counts	126

## 8.7 Communication

This menu facilitates testing on communication networks. A multiplexer in loop back mode is used to test the communication. The AC-2000 3G follows its own communication to check for failed hardware. Follow the instructions displayed on the screen.

To perform this test you must short RX with TX on the non-priority channel of the multiplexer

**PRESS ENTER TO CONFIRM**

# 9 Service Menu

The Service Menu items calibrate various AC-2000 3G functions.

- Temperature Calibration, page 71
- Humidity Calibration, page 72
- CO2 Sensor Calibration, page 72
- Static Pressure Calibration, page 73
- Light Sensor Calibration, page 74
- Feed Calibration, page 74
- Water Calibration, page 75
- Ventilation Potentiometer Calibration, page 75
- Save Settings to SD Card, page 76
- Read from SD Card, page 77
- WOD Calibration, page 78

SERVICE
1. TEMP. CALIBRATION
2. HUMIDITY CALIBRATION
3. CO2 CALIBRATION
3. STATIC PRESSURE CAL.
4. LIGHT SENSOR CALIBRATION
5. FEED CALIBRATION
6. WATER CALIBRATION
7. POTENTIOMETER CALIBRATION
8. NIPPLE FLUSHING
9. FEEDERS & DRINKERS
10. SAVE SETTINGS
11. LOAD SETTINGS
12. W.O.D/ CALIBRATION

## 9.1 Temperature Calibration

The AC-2000 3G temperature sensors are typically accurate to approximately 0.5° F within the range of temperatures for poultry production. Calibrate them in this menu by adding/subtracting a constant correction factor to each sensor. Adjust the sensor of your choice with the left/right arrow keys.

TEMPERATURE CALIBRATION		
Sensor	Temp°	Factor
1	78.2	1.6
2	86.4	0.9
3	83.0	-1.5
4	86.2	0.8
5	85.2	-1.6
6	84.2	0.0

Calibrating against infrared or in air temperature sensors generally results in less accuracy than the basic sensors have without calibration.

**CAUTION** *Only calibrate the sensors if you have reason to believe that they are producing inaccurate results.*

### To calibrate the sensor:

1. Obtain an accurate reference sensors and a pail of water at the approximate temperature desired.
2. Stir the reference sensor together with the AC-2000 3G sensor vigorously in the bucket of water. Keep hands off the sensor itself, so that it responds accurately to the water temperature. Stirring is necessary to preclude stratification within the bucket of water.

3. Call out the accurate reading to a second person standing at the AC-2000 3G. Walkie-talkie radios may be a good idea.
4. The individual at the controller should double-check that you are calibrating the correct sensor. You might warm/cool the sensor temporarily to see which sensor changes temperature appropriately.
5. Once you determine the correct temperature and allow approximately one minute for stabilization in the water, adjust the sensor reading at the controller.
6. Offset the factor using the left/right arrow keys.
  - Refer to Temperature Curve, page 9.

## 9.2 Humidity Calibration

To calibrate the humidity level, obtain a suitable humidity test kit, and use the procedures described there. They are commonly available via the Internet.

**CAUTION** *Only calibrate the sensors if you have reason to believe that they are producing inaccurate results.*

HUMIDITY CALIBRATION		
Sensor	Humidity°	Factor
In-1	58.9	2.3
In-2	58.9	2.3
Out	N/A	---

- Adjust the AC-2000 3G reading as needed using the left/right arrow keys.

Refer to Humidity Treatment, page 17.

## 9.3 CO2 Sensor Calibration

To calibrate the CO2 level, obtain a suitable test kit and use the procedures described in the kit. Ensure that the house is well ventilated.

**CAUTION** *Only calibrate the sensors if you have reason to believe that they are producing inaccurate results.*

CO2 SENSOR CALIBRATION	
	Value
PPM at 4 mA/1 VDC	26
PPM at 20 mA/5 VDC	3000
Factor (PPM)	22

CO2 (ppm):  
482

- Ppm at 4 mA / 1 VDC: Parts per million for 4 mA or 1 VDC
- Ppm at 20 mA / 5 VDC: Parts per million for 20 mA or 5 VDC

- **Factor (ppm):** (-/+ ) ppm shift from the current reading
- **CO2 (ppm):** Current CO2 readings
- Adjust the AC-2000 3G reading as needed using the left/right arrow keys.
- Refer to CO2 Treatment, page 19.

## 9.4 Static Pressure Calibration

The Static Pressure should be 0 when there is no ventilation and the house is closed. When the controller A/D counts is 100, this means that there is zero (0) static pressure.

**CAUTION:** The Static Pressure sensor is factory calibrated. Only calibrate the sensor if you have reason to believe that they are producing inaccurate results.

**NOTE:** *Run AC-2000 3G for a few hours so that the temperature in the box becomes stable and only then calibrate.*

**CAUTION** *DO NOT blow the air into the hose to see of the pressure changes! The sensor is sensitive and blowing air can cause irreparable damage.*

### To calibrate the Static Pressure Sensor:

1. Disconnect the air hoses.
2. Go to *Service > Static Pressure Cal.*
3. If the A/D count is 100 +/- 30 (70 to 130), press **Enter**.
4. If the A/D count is less than 70 or greater than 130:
  - a. Check for blocked air hoses or wind interference.
  - b. Adjust the zero pressure reading to approximately 100 by turning the calibration screw.
  - c. When the A/D count is within the permitted range, press **Enter**.

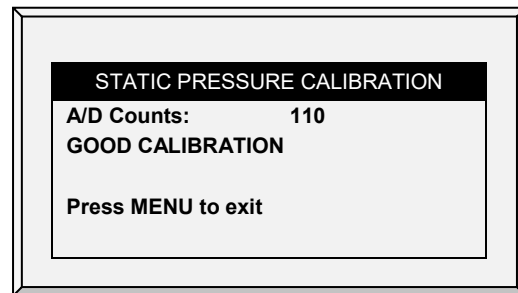
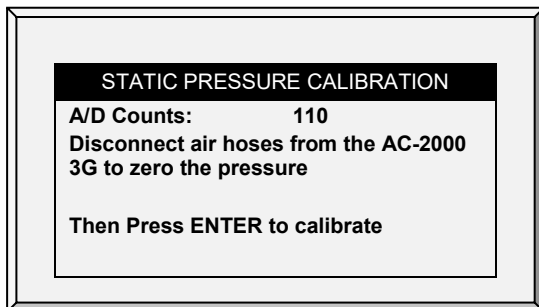

The static pressure sensor is located inside the controller in the upper left hand corner to the left of the power supply.

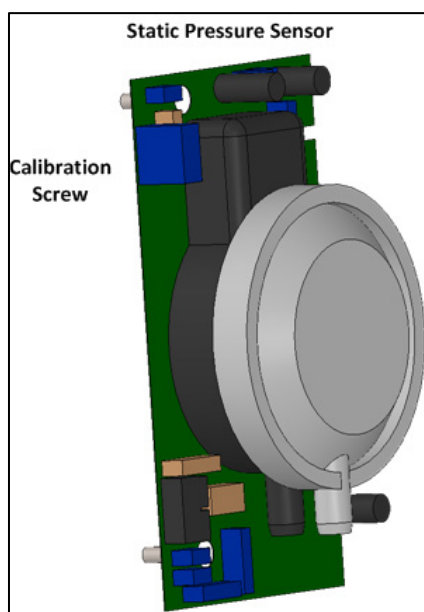

Refer to Static Pressure.

## 9.5 Light Sensor Calibration

Installing a light sensor enables turning off the lights when there is sufficient outside light.

**To calibrate the light sensor:**

1. Go to *Install > Analog Sensors*.
2. Define one sensor as a light sensor.
3. Go to *Device > Light*.
4. Press **Help**, highlight **Set**, and press **Enter**.
5. Scroll down to **Light Sensor Active** and set to **Yes**.
6. Place the sensor in the required location.
7. Go to *Service > Light Sensor Calibration*.
8. When the outside light is bright enough, press **Enter**

## 9.6 Feed Calibration

The AC-2000 3G can use feed bin scales or less expensive digital monitoring devices to keep track of your feed. This menu calibrates the digital monitoring devices.

**To calibrate the digital monitoring device:**

1. Select the feed counting method. Your digital monitoring device may generate a dry contact pulse for each quantity of feed, or it may simply indicate that the feed is running.
2. Enter the quantity of feed per pulse in case you use a dry contact pulse. Otherwise, enter the amount of feed delivered per minute of auger operation.
3. Select one of the following:
  - **Pulse:** Weight per pulse
  - **Time:** Weight per minute
4. Enter quantity (weight per minute or per pulse).

FEED CALIBRATION		
Feed	1	2
Method Factor	TIME 2.203	TIME 2.203

Method Pulse: Weight per Pulse  
Method Time: Weight per Minute

## 9.7 Water Calibration

The AC-2000 3G supports (up to) four dry contact pulse output water meters. Enter the quantity of water per pulse for your water meters.

WATER CALIBRATION			
Water 1	-	Water Per Pulse	Time
Water 2	-	Water Per Pulse	Time
Cool Pad	-	Water Per Pulse	2.203
Fogger	-	Water Per Pulse	2.203

## 9.8 Ventilation Potentiometer Calibration

Use this screen to calibrate the ventilation potentiometer control. Potentiometer calibration is required before ventilation can be controlled via a potentiometer.

POTENTIOMETER CALIBRATION				
Pot	Device	Close	Current	Open
1	Vent 1	152	0	1000
2	Vent 2	152	0	1000

### ☛ Before calibrating the potentiometers:

- Disable the static pressure unit in *Install > Setup*.
- Define at least one relay as vent/inlet/tunnel in *Install > Relay Outlet*.
- Define at least one analog sensor as a potentiometer in *Install > Analog Sensor*.

### To calibrate the potentiometer:

1. Select a potentiometer number.
2. Press **Enter**.

The device relay closes and then opens. As this takes place, the numbers in the Close, Current, and Open columns change. After a few minutes, the process completes and a "Good Calibration" message appears.

*NOTE After potentiometer calibration, the times displayed in the Vent/Curtain Setup screen change. Refer to Vent & Curtain Levels, page 36 for details.*



## 9.9 Save Settings to SD Card

This menu enables the user to save his program settings to a SD card and transport them to another controller for quick programming.

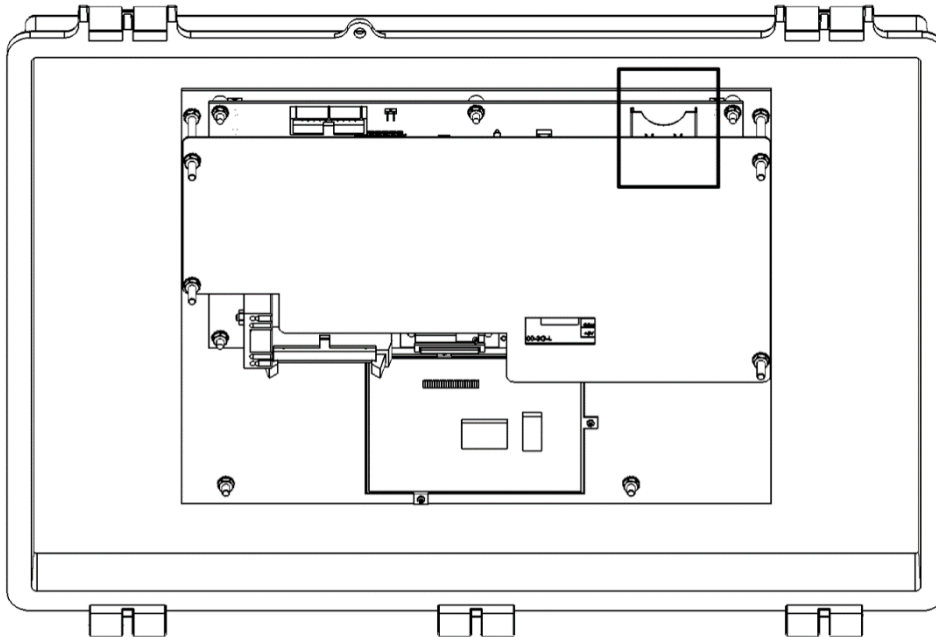

**NOTE** Verify that the SD card is in the “Unlocked” position (see the following illustration). The card must be in the Unlocked position to enable software upgrades.

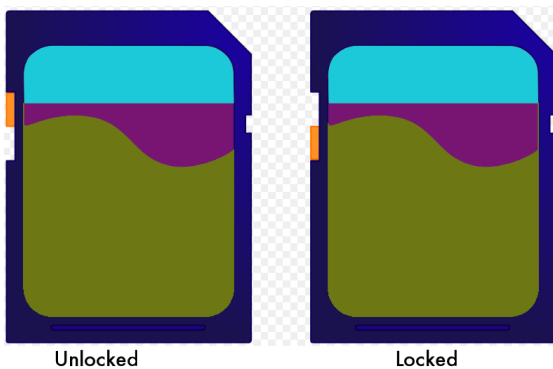

➡ An SD card must have 20K free space to save settings.

1. **Insert** SD Card into place as shown above.
  2. Go to *Service > Save to SD Card*.
  3. In the screen that appears, press **YES**.
  4. In the screen that appears, select the required settings and press **Enter**.
  5. In the screen that appears, press **YES**.
- Settings are saved to the card.

**CAUTION** While saving, do not remove the card or interrupt the process in any way!

## 9.10 Read from SD Card

This menu enables reading a saved program from a SD card into the controller quickly and reliably rather than configuring the settings manually.

**CAUTION** Make sure that the program data is identical to the relay layout of the controller.

➡ An SD card must have 20K free space to save settings.

1. Insert SD Card into place.
2. Go to *Service > Read From SD Card*.
3. In the screen that appears, select the required settings and press **Enter**.
4. In the screen that appears, press **YES**.

**CAUTION** While reading, do not remove the card or interrupt the process in any way!

### 9.10.1 LOAD SETTINGS REPORT

**NOTE** Version 9.19 and above supports this function.

When uploading settings to a controller, AC-2000 3G which tables (if any) will not be transferred. Compatibility issues might arise in cases when transferring settings between controllers using different software versions or having different configurations. By listing which tables will not transfer, the user knows which tables must be defined manually.

1. Go to *Service > Load Settings*.
2. In the screen that appears, select **YES** and press **Enter**.
3. Select the required settings and press **Enter**.
4. If there are any incompatible tables, a list of the pathways appears.

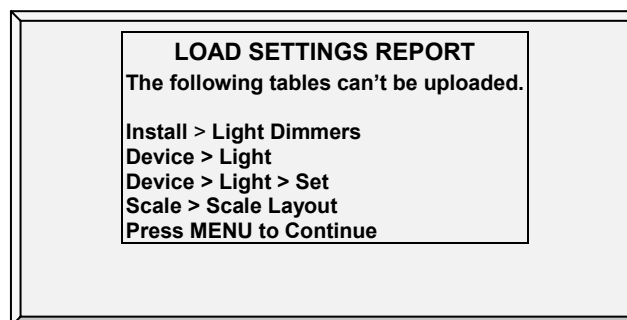

5. Press **Menu**. The following message appears:

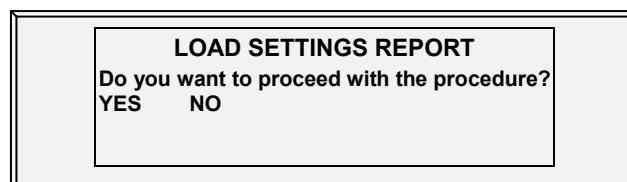

6. To proceed, select **YES**.
  - After loading the settings and resetting the controller, a record of incompatible tables can be viewed in Table of Events (page 67). Note that pathway is shown using a number to indicate the menu.

TABLE OF EVENTS			
	Event	Day	Time
20	Tunnel Ventilation	2	1:15:50
21	Minimum Ventilation	2	1:30:43
22	8. Light Dimmers	2	4:14:44
23	2. Light	2	4:14:44
24	2. Light / Set	2	4:14:44
25	4. Scale Layout	2	4:14:44
26	Data Read From Plug	2	4:14:44

## 9.11 WOD Calibration

➤ Define an analog sensor as WOD.

WATER ON DEMAND CALIBRATION		
	Volt	Pressure - PSI
WOD 1st Calib.	2.50	14.50
WOD 2nd Calib.	7.50	43.50

**READ ME**

Enter output voltage for first point.  
 Enter water meter measure pressure.  
 Repeat this for the second point.

1. In *Installation > Setup*, set the Length Unit.
  - Metric = Bar
  - Non Metric = PSI
2. In *Service > WOD Calibration*:
  - a. Enter the first voltage and check pressure data points.
  - b. Repeat for second data points.
3. Set the Help Definitions (optional)

### 9.11.1 WOD CALIBRATION HELP | SET DEFINITIONS

This parameter reduces the water pressure a user-defined factor.

SYSTEM PARAMETERS	
<b>WATER ON DEMAND</b>	
Pressure Reducer Factor	50.00

1. In *Install > Setup*, define the Pressure unit.
2. In *Service > WOD Calibration > Help*, define the reduction factor. Water pressure is reduced by 1/50 (bar or PSI). The factor is accurate to two decimal points.

# 10 Install Menu

The Install Menu items are used when installing input and output devices, as well as configuring critical parameters needed to run your controller properly.

- Setup, page 79
- Digital Sensors, page 82
- Temperature Definition, page 85
- Communication, page 86
- Relay Layout, page 80
- Analog Output, page 83
- Fan Air Capacity, page 86
- Analog Sensors, page 81
- Vent/Curtain Setup, page 83
- House Dimensions, page 86

## 10.1 Setup

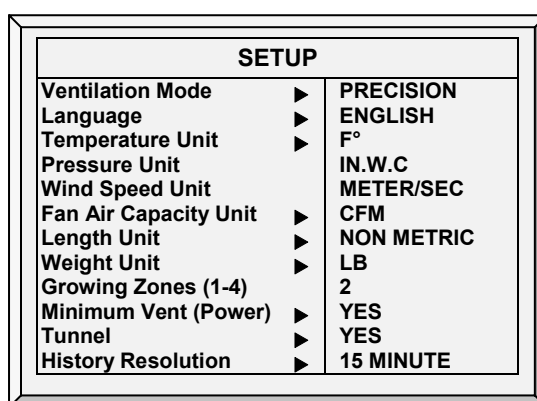
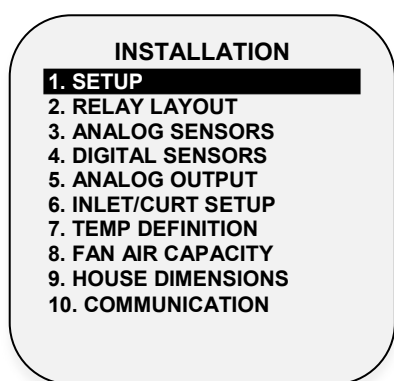

Set the following:

Language	As required
Temperature Unit	Celsius / Fahrenheit
Pressure Unit	Milibar / Inches of WC (Water Column) / Pascal / cm of WC / mm of WC / None
Wind Speed Unit	Km Per Hour / Mile per Hour / Meter per Sec / Feet per Sec
Fan Air Capacity Unit	Cubic feet per minute (CFM) / Cubic meter per hour (M3/H)
Length Unit	Meter / Feet
Weight Unit	Pounds (LB) / Kilograms (KG)
Growing Zones	1/2/3/4
Minimum Vent (Power)	YES (power) / NO
Tunnel	YES / NO
History Resolution	1 minute / 5 minute / 10 minute / 15 minute / 30 minute / 1 hour / 2 hours

### 10.1.1 STATIC PRESSURE UNIT DEFINITION

Enabling/disabling a static pressure unit determines the ventilation method used in the chicken/animal house:

- **Static pressure unit enabled:** After selecting any method, refer to Static Pressure, page 27 to define the static pressure parameters.
- **No unit enabled:** If you choose **None**, ventilation is controlled by time or a potentiometer. Refer to Vent & Curtain Levels, page 36.

## 10.2 Relay Layout

Use this menu to define the devices connected to the controller. There are (up to) 20 available relays.

1. Select the requested choice from the menu list by using the up/down cursor keys (refer to Supported Relays). AC-2000 3G numbers the relay automatically.

*NOTE* If required, you can set the relay number manually.

2. If required, press +/- to designate the relay as NO/NC.
3. To duplicate relays (meaning all definitions of a relay) use the 'As Relay # X' where 'X' stands for a relay number defined already in the system. Scroll down to 37 to use this function.

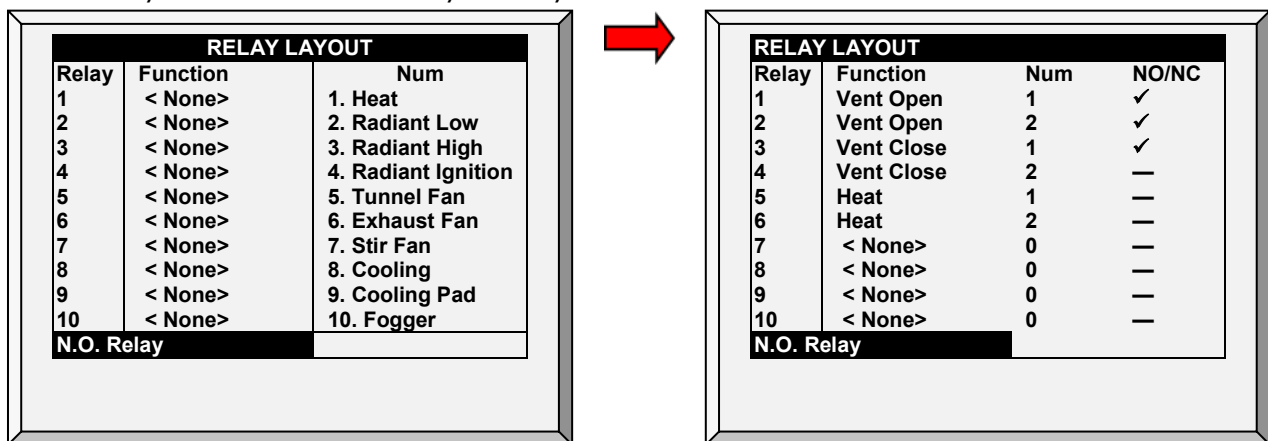

### 10.2.1 SUPPORTED RELAYS

Number	Output Function
1.	Heaters
2.	Radiant Heaters (Low/High/Ignite)
3.	Tunnel Fan
4.	Exhaust Fan
5.	Stir Fan
6.	Cool
7.	Cool Pad
8.	Fogger
9.	Vent Open
10.	Vent Close

Number	Output Function
11.	Vent Open
12.	Vent Close
13.	Curtain Open
14.	Curtain Close
15.	Attic Open
16.	Attic Close
17.	Vent Speed
18.	Water
19.	Feeder
20.	Auger
21.	Extra System
22.	Alarm (N.C.)
23.	Water Main
24.	Water Bypass
25.	Water Line
26.	WOD
27.	As Relay
28.	AS Analog Output

### 10.2.2 RELAY LAYOUT – HELP | SET DEFINITIONS

② While viewing the **Relay Layout menu**: Press **HELP**, select **SET**, and press **ENTER**.

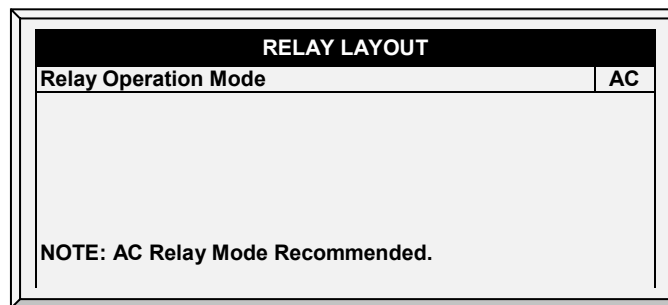

- Define relay operation mode: DC or AC.

AC mode produces less heat in the controller box.

### 10.3 Analog Sensors

This selection enables the user to configure the analog sensors. The AC-2000 3G regards various sensors as well as circuit breakers as analog sensors. These sensors measure a continuous range rather than just on or off.

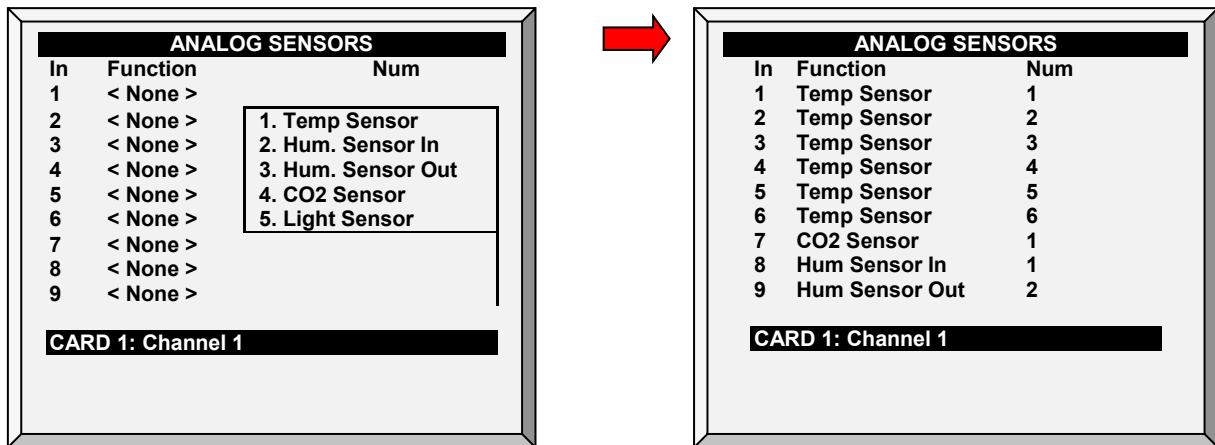

- Enter temperature / humidity sensors wired to each input (setup according to technician).
  - When installing a dedicated humidity sensor, set analog input 9 as the humidity sensor.
  - When installing temperature sensors, define inputs 1 - 6 only as temperature sensors.
  - When installing CO2 or lights sensors on inputs 1 - 6, place the jumpers on the 4 - 20 mA position (refer to Figure 14).
  - To install additional humidity sensors or potentiometers place the jumpers on:
    - 0-3V position (humidity sensor)
    - POT position (potentiometers)

Refer to Figure 14.

- If sensor numbers duplicate, the sensors average.

## 10.4 Digital Sensors

This option enables configuring two digital sensors. These sensors monitor both water and feed consumption if the building is equipped accordingly. Digital inputs include on/off and pulsing inputs such as auxiliary alarms, pulsing water meters and feed.

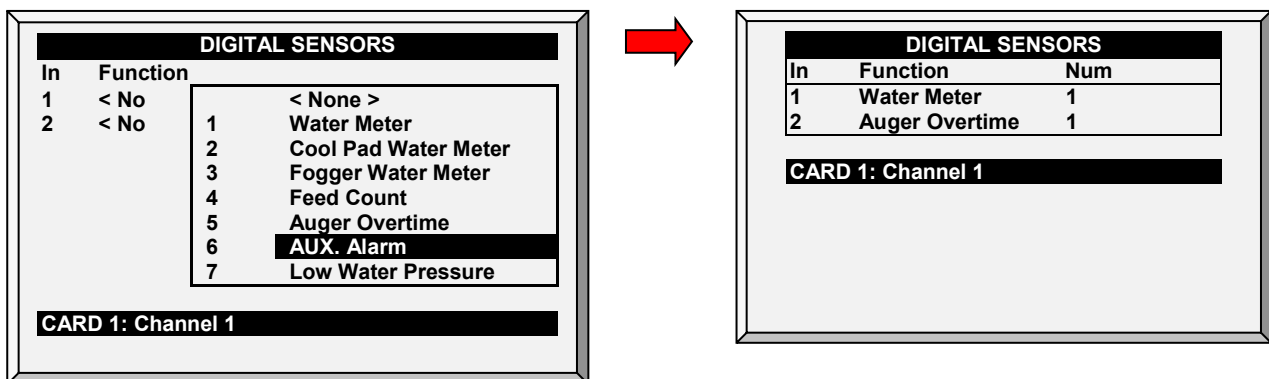

- Enter sensors wired to each input (setup according to technician)

## 10.5 Analog Output

This selection controls light dimmers, variable speed fans and variable heaters. Select the required output function from the menu list and insert the approximate output voltages.

ANALOG OUTPUT				
Out Num	Function	Num	Min V.Out	Max V. Out
1	< None >	0	0.0	0.0
2	< None >	0		

ANALOG OUTPUT				
Out Num	Function	Num	Min V.Out	Max V. Out
1	Variable Speed	1	0.0	10.0
2	Light Dimmer	1	0.0	10.0

Card 1: Channel 1

- Enter sensors wired to each input (setup according to technician). The above is an example of an analog output configuration
- To configure the light dimmers, refer to Light, page 43.
- To configure the variable speed fans, refer to Stir Fan Levels, page 37.
- To configure the variable heaters, refer to Temperature Curve Help | Set Definitions, page 10.

## 10.6 Vent/Curtain Setup

Use this screen to define the ventilation opening and closing mechanism. You can use one of these two methods:

- Time
- Potentiometer

If you map a curtain or vent to a potentiometer, the AC-2000 3G controller uses that method (and not time).

➡ Define at least one relay as curtain, tunnel, or vent.

*NOTE* After defining the method used, define the opening levels in Vent & Curtain Levels, page 36.

### 10.6.1 USING TIME TO CALIBRATE

Enter the number of seconds to open and close from limit to limit for each of the Vents and Curtains in your installation. The AC-2000 3G then calculates the percentage of open and closed time and adjusts the static pressure methods accordingly.

VENT / CURTAIN SETUP				
	Curtain	Pot	Open (sec)	Close (sec)
~	Curtain 1	NONE	60	60
~	Curtain 2	NONE	60	60
~	Inlet 1	NONE	60	60

Set full open/full close time (in seconds) for Curtains, Tunnel, 1<sup>st</sup> & 2<sup>nd</sup> Vent, and Attic Vent.

*NOTE* Default is set at 60 seconds.

*NOTE* Munters recommends setting the [Help parameters](#) to maintain an accurate position.

*NOTE* The ~ symbol designates an analog output device.



### 10.6.2 USING A POTENTIOMETER TO CALIBRATE

Each curtain/vent/inlet can be mapped to a potentiometer. Potentiometer feedback enables precise positioning on each specific device opening value. In this screen, assign a potentiometer to a device.

VENT / CURTAIN SETUP				
	Curtain	Pot	Open (sec)	Close (sec)
~	Curtain 1	POT 1	60	60
	Curtain 2	POT 2	60	60
~	Inlet 1	POT3	60	60

1. Map the analog sensors as potentiometers as required (Analog Sensors, page 81)
2. Map the curtain/vent/tunnel to a potentiometer in this screen.

*NOTE* The number of the devices that you can map equals the number of potentiometer relays.

3. Calibrate the potentiometer (Ventilation Potentiometer Calibration, page 75).

*NOTE* After calibrating the potentiometer, the times shown here change to reflect the calibration process.

In the event that the potentiometer fails (meaning there is no value change during the curtains/vents/inlets movement):

- Alarm message is transmitted
- The specific curtain/vent/inlet mapped to the failed potentiometer starts operating by time calculation, using the times calculated by the calibration process. However, if required you can enter new opening and closing times.

### 10.6.3 VENT/CURTAIN HELP | SET DEFINITIONS

These parameters enable maintaining an accurate curtain position when using time to calibrate.

- ⑦ *While viewing the Vent/Curtain menu: Press HELP, select SET, and press ENTER.*

SYSTEM PARAMETERS	
<b>CURTAIN CALIBRATION</b>	
From Time	0:00
To Time	0:00
Number of Steps	0
Power Vents Calibration	NO
Proximity to Edge %	10
Close Below This Temp. (out)	0.0

- **From/To Time:** Time period in which calibration is enabled
- **Number of Steps:** number of steps for automatic calibration: Set calibration point for curtain after desired amount of curtain opening/closing (steps). During calibration, if the curtain is open more than 50% it opens to 100%, calibrates, and returns to the previous position. If the curtain is open less than 50% it closes to 0%, calibrates, and returns to the previous position. Default: 99.
- **Power Vents Calibration:** This parameter enables automatic calibration of air inlets when recovering from a power outage. In many installations the backup system, such as Munters' FBU-27, may have opened the air sources. When the AC-2000 3G takes over control again,

the air inlets are incorrectly positioned. The calibration at power up feature synchronizes the actual position and the controller.

- **Proximity to Edge %:** Curtain will open or close based on this proximity to the edge. For example, when set to 10%, the curtain closes when the opening is less than 10% and opens completely when the opening is greater than 90%.
- **Close Below This Temp. (out):** Curtains close when the outside temperature reaches this point.

➡ **This parameter requires defining a temperature sensor as an outside sensor (refer to Temperature Definition, page 85).**

*NOTE The Proximity to Edge % parameter takes priority over the Close Below This Temp parameter. Meaning, if the outside temperature mandates closing the curtain, the curtains will still open if they are within the proximity defined in the Proximity to Edge parameter.*

## 10.7 Temperature Definition

This menu assigns specific temperature sensors for various brood setups and for heater zones. Moreover, assigning sensors to particular devices is possible. Note that if the sensors selection remains blank, the default value is assigned.

Choose up to six temperature sensors for each item listed by using the '+/-' keys. The house, brooding and tunnel sensors cause the current average to apply to devices when no specific sensor is assigned to them. The current average substitutes for either failed or missing sensors.

TEMPERATURE DEFINITION	
Function	Temp. Sensor 1 2 3 4 5 6 7 8 9
Full House	√√√ . . . . .
Tunnel setting	. . . . .
Attic	. . . √ . . .
Outside	. . . . √ . .
Stir Fan 1	. . . . √ . .
~ Stir Fan 2	. . . . √ . .
~ Var. Heat 1	. . . . √ . .

- Press +/- key to add/remove ✓ to assign temperature sensors to corresponding function.
- When an attic sensor is not installed, the attic vent is disabled.
- Assign Temperature Sensors as required in **Install | Temp Definition**. Devices that do not accept temperature sensors, such as Exhaust Fans, Tunnel Fans, Feed and Light do not appear.

*NOTE When an attic sensor is not installed, the attic vent is disabled.*

*NOTE The ~ symbol designates an analog output device.*

Note that Exhaust Fans and Tunnel Fans do not appear because the Ventilation Levels defined in **Device | Levels of Ventilation** control their operation. Stir Fans appear even though the **Device | Stir Fan Levels** apply to them because they simultaneously operate according **Device | Stir Fan Programs** where specific sensor assignments are required in Program B and recommended in Program C.

## 10.8 Fan Air Capacity

This option enables defining the fans' air capacity. Insert fan air capacity for both the exhaust and tunnel fans. The units are as chosen in **INSTALL | SETUP**.

FAN AIR CAPACITY	
Fan	CFM
Tunnel Fan 1	24600
~ Exhaust Fan 1	24600

1. In *Installation > Relay Layout* and/or *Installation > Analog Output*, define the fans.
2. In *Installation > Setup*, define the fan air capacity unit.
3. In *Installation > Fan Air Capacity*, define air capacity (default setting shown above).

*NOTE* This information enables the display of air capacity for each level in the *Levels of Ventilation* table.

*NOTE* The ~ symbol designates an analog output device.

## 10.9 House Dimensions

The selection allows the user to set its' house dimensions. Set it according to actual house size. These dimensions are used for calculating the wind chill factor (the chilling effect of the wind that can significantly lower the temperature). This information enables the calculation of the Wind Chill factor displayed in Hot Screen Key = 2 (Tunnel mode only).

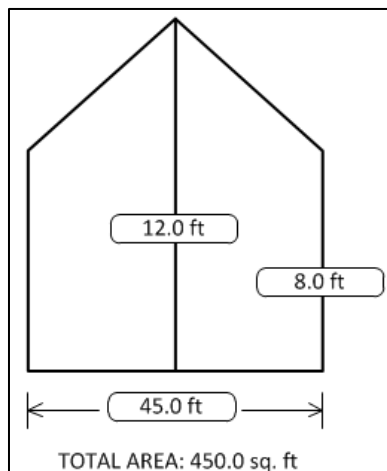

- Define height, width, and length of house (Controller calculates total area).
- To set the dimensions in metric or non-metric units, go to *Installation > Setup* and scroll down to Length Unit.

## 10.10 Communication

This menu defines the communication parameters.

COMMUNICATION SETUP	
Baud Rate	9600
House Number	1
	1200
	2400
	9600
	19200
	38400

- **Baud rate:** This parameter is a measure of the communication speed for local or remote communications to a PC. The default is 9600 represents a data rate of approximately 1000 characters per second. If the connection fails at this speed, try a lower speed.
- **House number:** Each controller on a network must have a unique number so Munters' communication software can distinguish individual controllers. Note that these numbers are from 1 to 64.

# 1 1 Technical Specifications

<b>Input Power Voltage</b>	One Phase 115 ± 10 VAC (USA and Canada)
	230 ± 20 VAC (Outside USA and Canada)
	0.5 Amp, 50-60Hz
<b>Relay Loads</b>	5.0 Amps, 250 Volts, Fused
<b>Analog Inputs</b>	0 - 11 Volts, 10 Milliamps Maximum
<b>Analog Output</b>	0 - 10 Volts
	Current Limited with 100-Ohm Resistor
<b>Digital Inputs</b>	5 ma @ 5 Volts, Dry Contact
<b>Operating Temperature Range</b>	0° to +50° C (32° to 125° F)
<b>Enclosure</b>	Water and Dust Tight
<b>Fuses</b>	Main fuse: 0.315 Amps, 250 Volts
	Others: 5 Amps, 250 Volts
<b>Professional certification</b>	<b>CB</b> <b>CE</b>

**CAUTION** For indoor use only!

# 12 Installation

This manual details the AC-2000 3G's physical installation procedures.

- Precautions, page 89
- Mounting the Unit, page 90
- AC-2000 3G Wiring, page 91

## 12.1 Precautions

- Grounding
- Filtering
- Checking the Battery Level
- Frequency Inverters

### 12.1.1 GROUNDING

- Always connect temperature and sensor shields to earth ground. Avoid mixing high voltage wiring with sensor and low voltage wiring.
- Keep the controller as far as possible from heavy contactor boxes and other sources of electrical interference.
- Do not connect communication wire shields, which go from one house to another at both ends. Connect them at one end only. Connection at both ends can cause ground loop currents to flow, which reduce reliability.
- The COM connection for communications is not the shield wire. The COM, RX and TX wires must connect to each other at all controllers.

### 12.1.2 FILTERING

If this installation includes a power inverter to drive variable speed fans, install an EMI filter in front of the inverter, according to the specifications provided by the inverter manufacturer. Refer to the inverter documentation.

### 12.1.3 CHECKING THE BATTERY LEVEL

Check the battery once a year. The output must be 2.7 volts (minimum). Authorized personnel only must replace the battery if the output is below the minimum required level or every five years.

### 12.1.4 FREQUENCY INVERTERS

Frequency inverters can cause severe electrical and electromagnetic interference. Therefore, when employing a frequency inverter, it is critical that you carefully follow the manufacturer's installation instructions. In particular verify:

- that the cable shielding between the inverter and any motor meets industry standards
- proper grounding of the inverter's chassis and motor power cable
- proper grounding of low voltage cable shield wire
- that the controller and inverter cables are kept in separate conduits or wire bundles

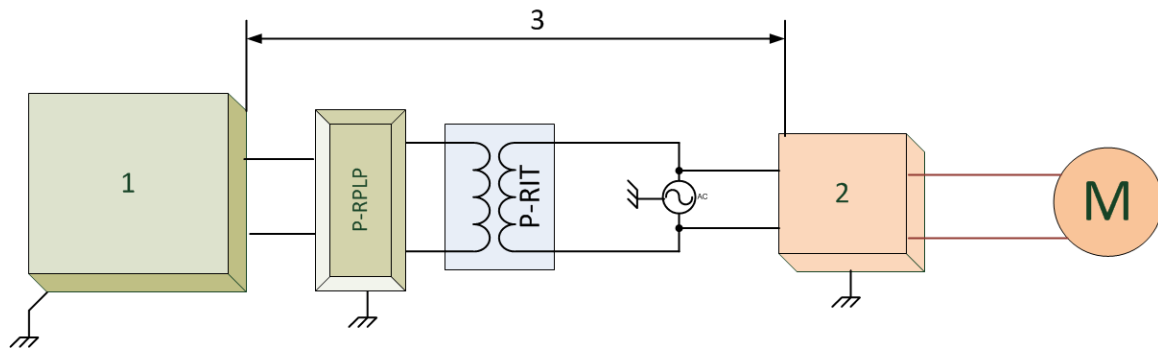

- 1. Controller
- 2. Inverter
- 3. Place the controller at least five meters from the inverter.

## 12.2 Mounting the Unit

1. Install the **AC-2000 3G** in a dry well lighted area, preferably in an annex to the main poultry house.
2. Mount it using the three holes provided; one in each of the left and right lower corners, accessible from the front under the terminal strip cover, and one top center in the back. The top center hole is a keyhole variety.
3. Install the screw for this hole first to about 0.1 inches of the wall surface. Then hang the control on this screw. Install the other two screws to fasten the **AC-2000 3G**.
  - Always connect temperature and sensor shields to earth ground. However, do not connect communication wire shields, which go from one house to another at both ends. Connect them at one end only. Connection at both ends can cause ground loop currents to flow, which reduce reliability.
  - The COM connection for communications is not the shield wire. The COM, RX and TX wires must connect to each other at all AC-2000 controls.
  - Avoid mixing high voltage wiring with sensor and low voltage wiring.
  - Keep the AC-2000 as far as possible from heavy contactor boxes and other sources of electrical interference.

Refer to Appendix D: Electrical Grounding for Controllers, page 113, for information on grounding the unit.

## 12.3 AC-2000 3G Wiring

The following sections detail the AC-2000 3G wiring.

- Board Layout, page 91
- Relays, page 92
- High Voltage Wiring (Relays), page 93
- Terminal, page 94
- Terminals Wiring, page 95

### 12.3.1 BOARD LAYOUT

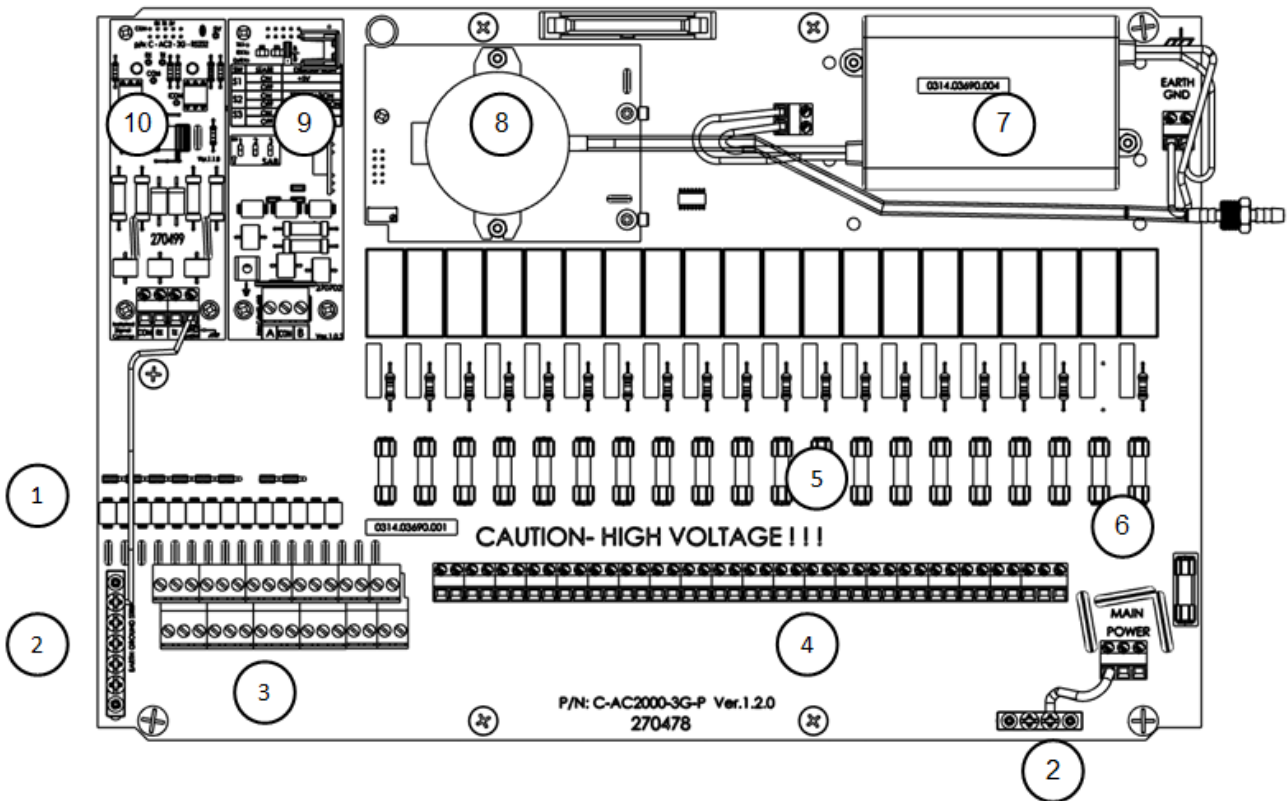

Figure 6: Board Components

- |                          |                           |
|--------------------------|---------------------------|
| 1: Jumpers               | 2: Ground strip           |
| 3: Low power terminals   | 4: 20 Relays              |
| 5: 5 Amp fuses           | 6: Input power            |
| 7: Power supply          | 8: Static pressure sensor |
| 9: 5V/RS-485 Termination | 10: Communication card    |



## 12.3.2 RELAYS

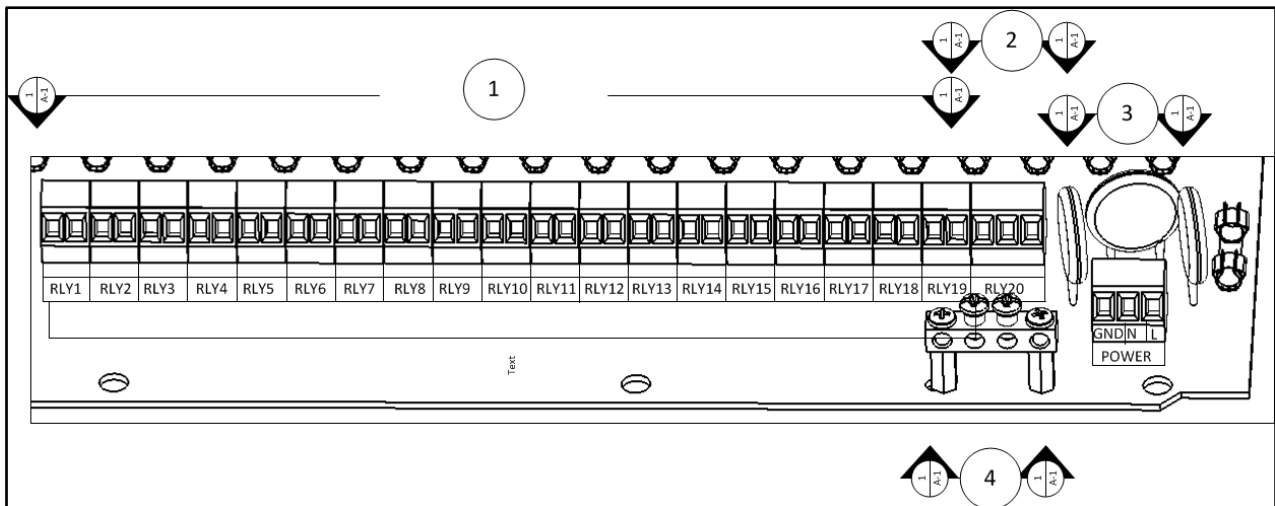
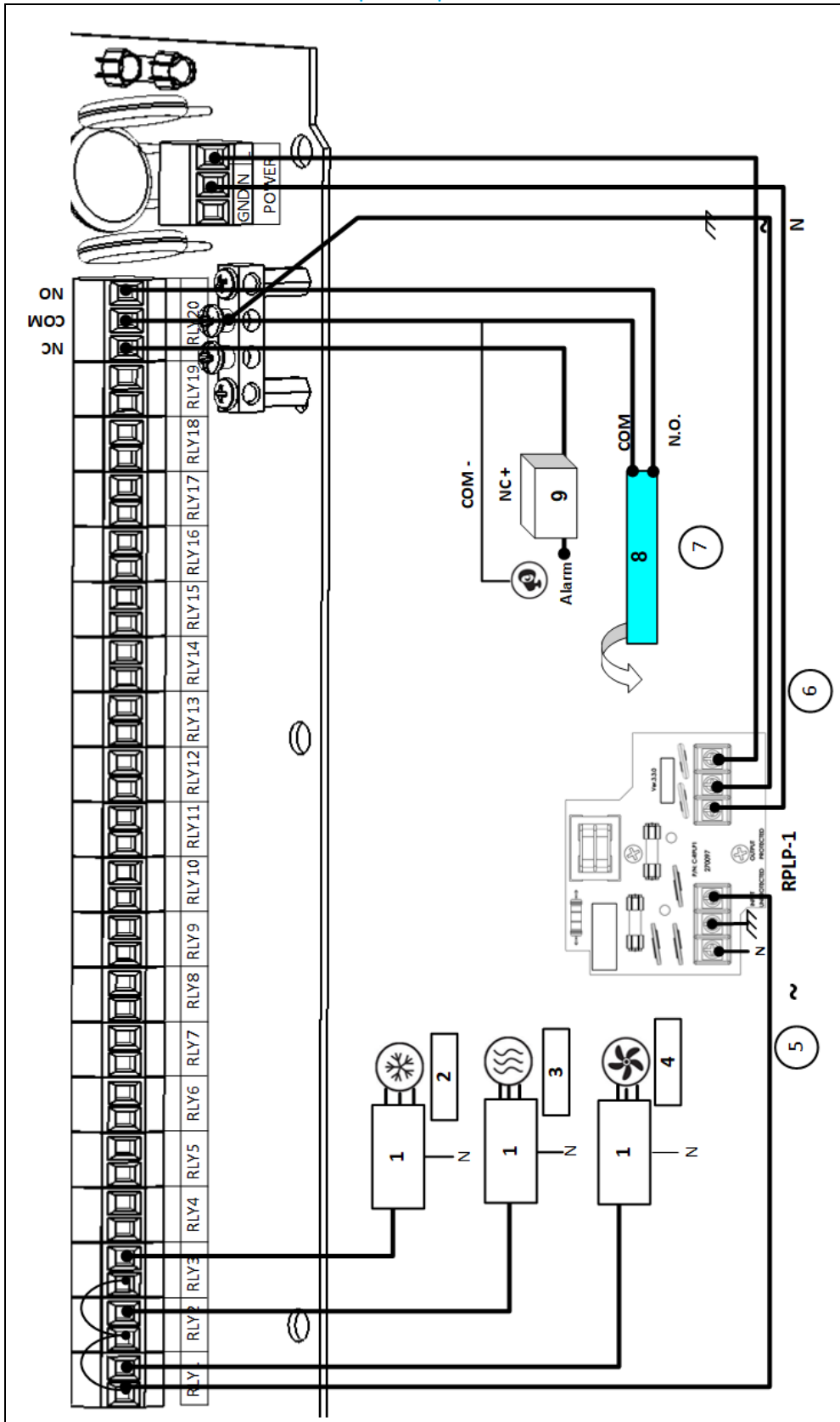

Figure 7: Relay Functions

- Relays 1 to 19:** Each pair of terminals goes to one relay. These relays are fused with a 5-ampere, 250-volt slow blow fuses. The relays are normally open when not powered.
- Relay 20:** Three terminal blocks: This relay normally serves as an alarm relay. It is also fused with a 5 ampere, 250 volt slow blow fuse, and can serve as an ordinary relay:
  - **NC:** Normally closed contact
  - **Com:** Common contact
  - **NO:** Normally open contact
- Power:** Three terminal blocks:
  - **Neutral (N):** Connect to the Neutral Power line.
  - **Phase (~):** Connect to the Phase Power line.
  - **Ground (GND):** Connect to a solid earth safety ground, normally with the bare safety ground wire, or a green wire.
- Ground:** Connect the ground wire to the electrical system.

### 12.3.3 HIGH VOLTAGE WIRING (RELAYS)



- 1: Contactor
- 2: Cooler 1
- 3: Heater 1
- 4: Fan 1
- 5: Unprotected input
- 6: Protected output
- 7: Alarm system activation occurs when there is a circuit opening between NO and COM.
- 8: Alarm system
- 9: 12 volt battery

Figure 8: High Voltage Wiring Example

NOTE The device connections (fan, heat, cool, etc.) shown in Figure 8 are only examples!

**CAUTION** Connect the AC-2000 3G power input to the protected output only!

### 12.3.4 TERMINAL SETUP

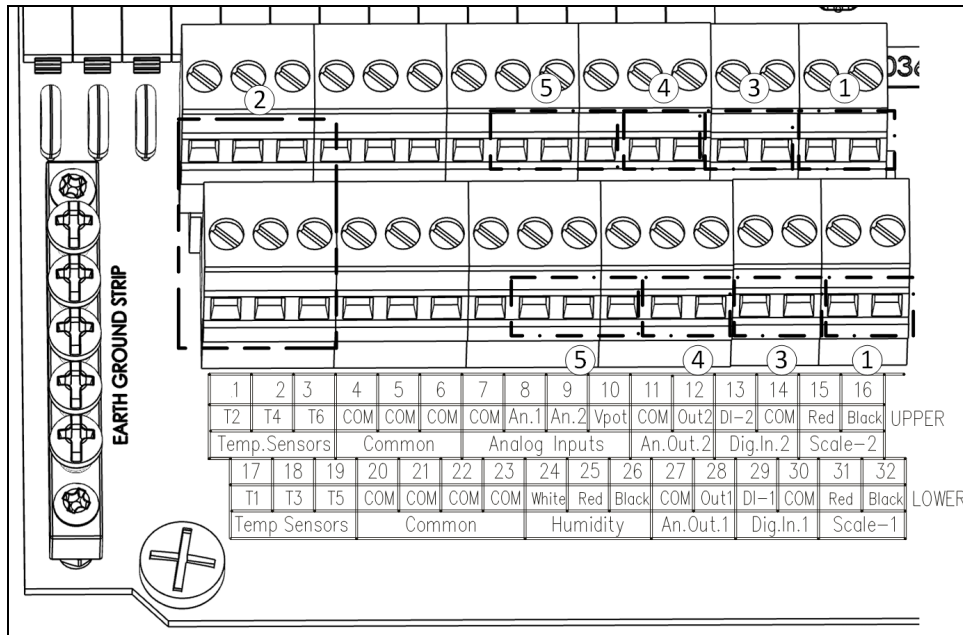

Figure 9: Terminal Functions

1. **Up to two optional bird scales:** Connect two wires of Scale 1 to SCALE 1 terminals (31, 32) and two wires of Scale 2 to Scale 2 terminals (15, 16).
2. **Six temperature sensors (1, 2, 3, 17, 18, 19):** The temperature sensor is a two wired black shielded cable thermistor (RTS-2). Connect one wire to the temperature sensor terminal and the other to common (4, 5, 20, 21) \*Polarity does not matter.
3. Digital Inputs:
  - Digital 1 (29): Various functions
  - Digital 2 (13): Various functions
  - COM (30, 14)
4. Analog Outputs:
  - Analog 1 (28): 0 to 10V
  - Analog 2 (12): 0 to 10V
  - COM (27, 11): Connect the common wire of Analog Output 1 and 2 to these terminals.
5. Analog Inputs:
  - Humidity Sensor (24, 25, 26): Connect according to wire colors (white, red, black).
  - Analog 1 (8): Various functions.
  - Analog 2 (9): Various functions
  - Vpot (10), connected to obtain inlet feedback potentiometer voltage.

**To setup the terminals:**

1. Wire the terminals to the required device.
2. Place the jumpers in the corresponding position (Figure 14).

### 12.3.4.1 Terminals Wiring

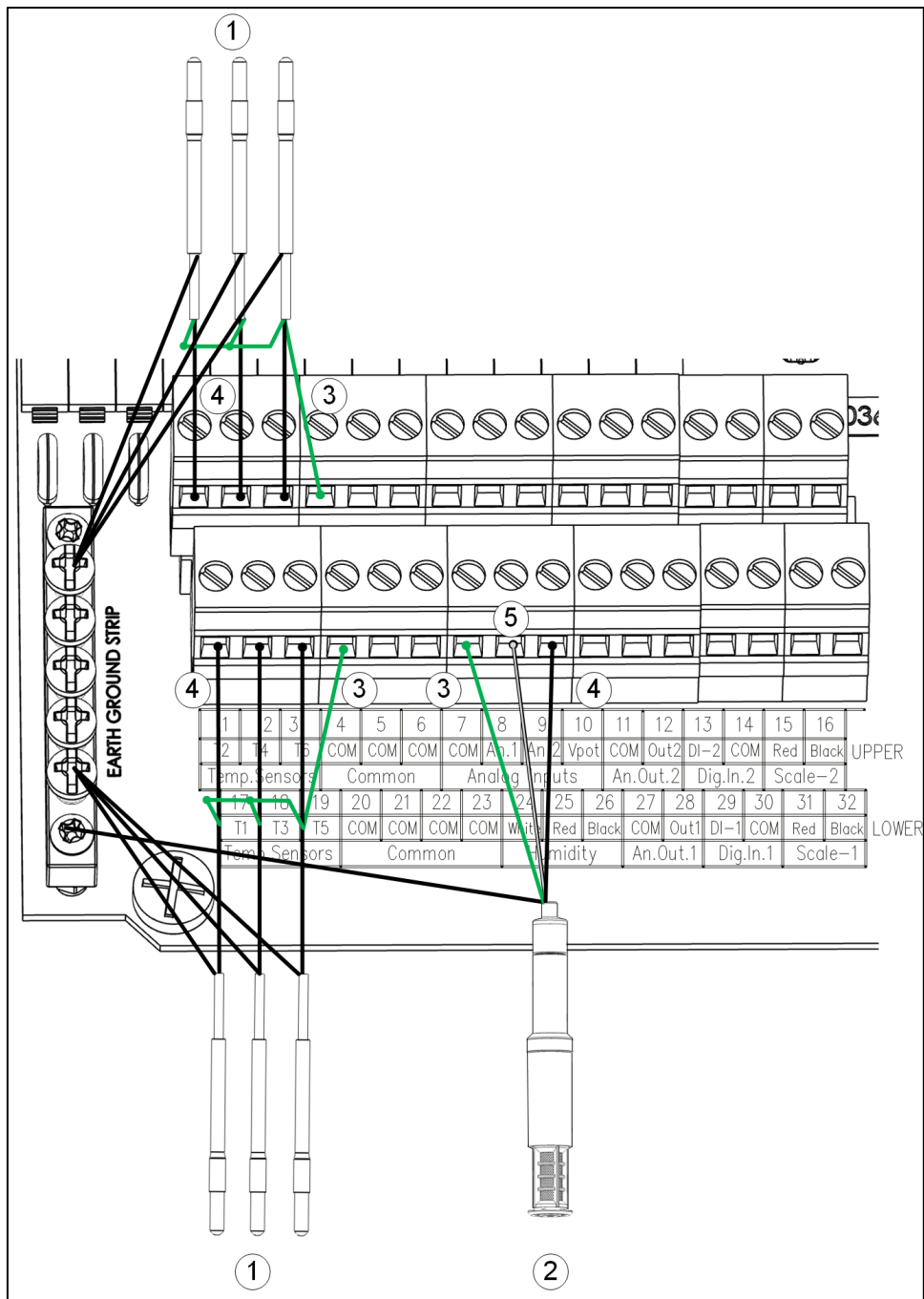

Figure 10: Terminal Wiring: Temperature and Humidity Sensors

**CAUTION** Connect each cable's shielding wire to the grounding strip. Figure 10 is an example only.

1: RTS

2: RHS + humidity sensor

3: Green wire

4: Black wire

5: White wire

**NOTE** Users wanting to install a second humidity sensor or CO2 sensor, refer to Appendix B: Installing a CO2 Sensor and Second Humidity Sensor, page 107.

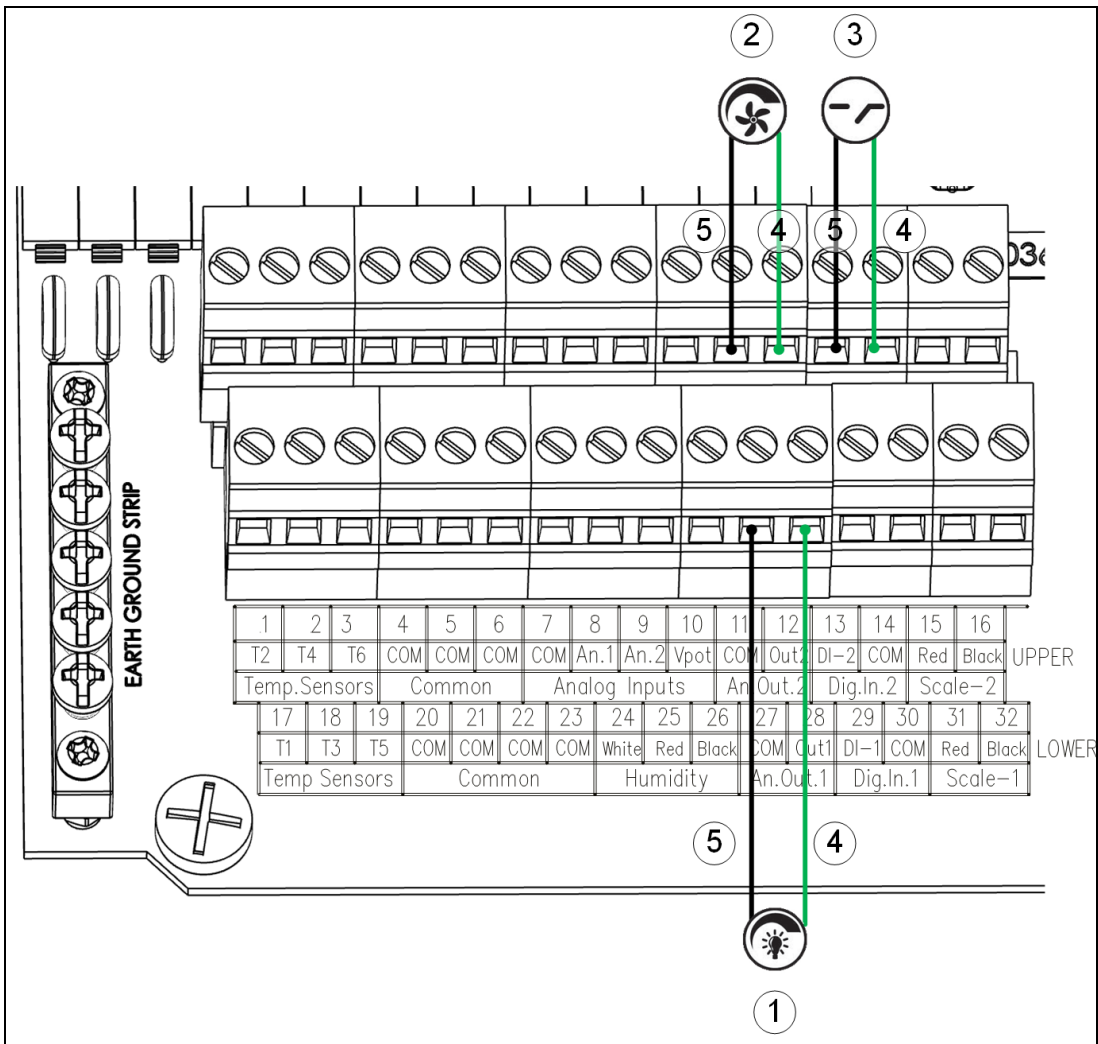

Figure 11: Terminal Wiring: Analog Output and Digital Devices (example)

- 1: Light dimmer
- 3: Feed meter
- 5: Black wire

- 2: Variable fan
- 4: Green wire

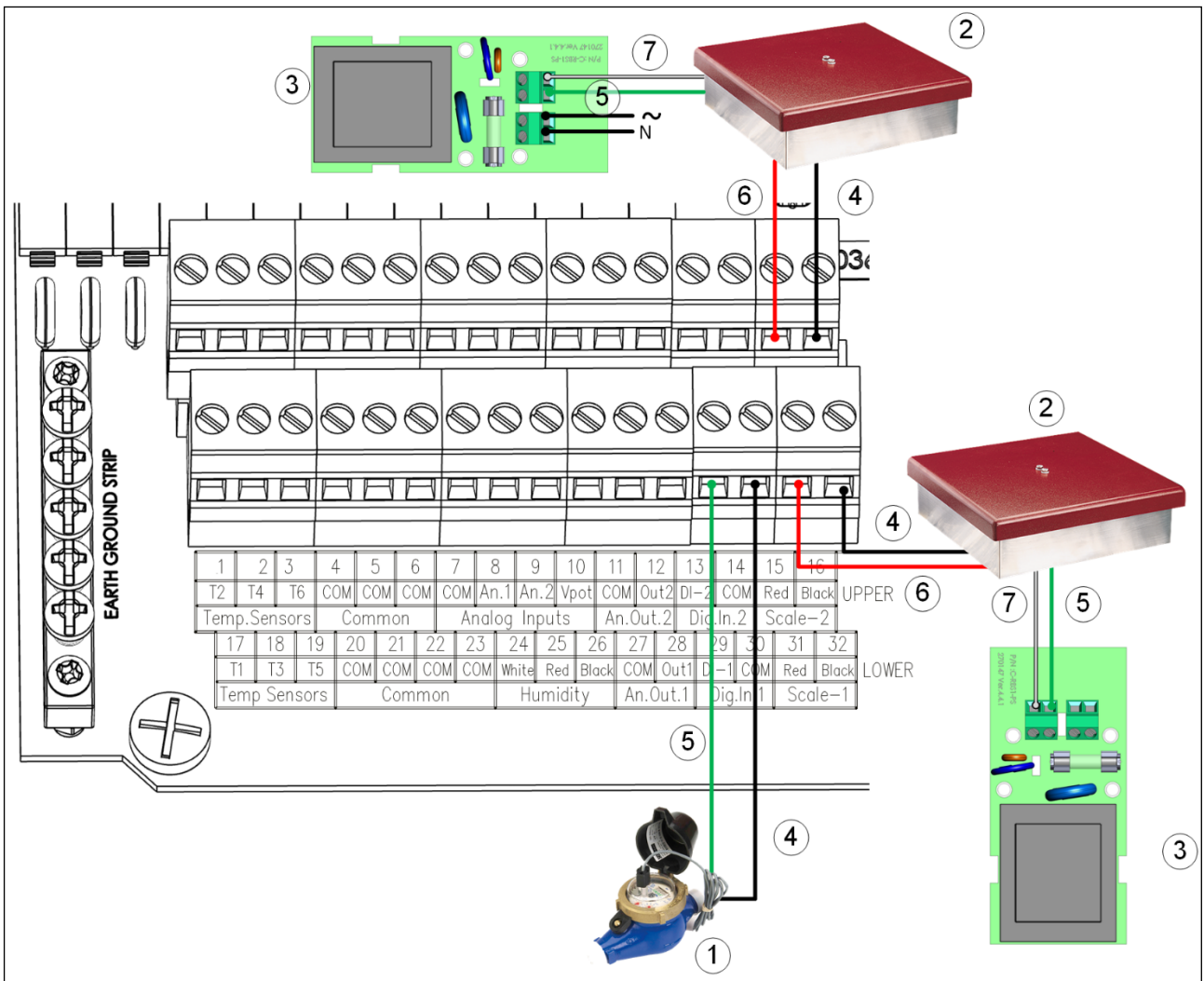

Figure 12: Terminal Wiring: Bird Scales and Water Meter (example)

- |                            |               |
|----------------------------|---------------|
| 1: Water meter             | 2: Bird scale |
| 3: Bird scale power supply | 4: Black wire |
| 5: Green wire              | 6: Red wire   |
| 7: White wire              |               |

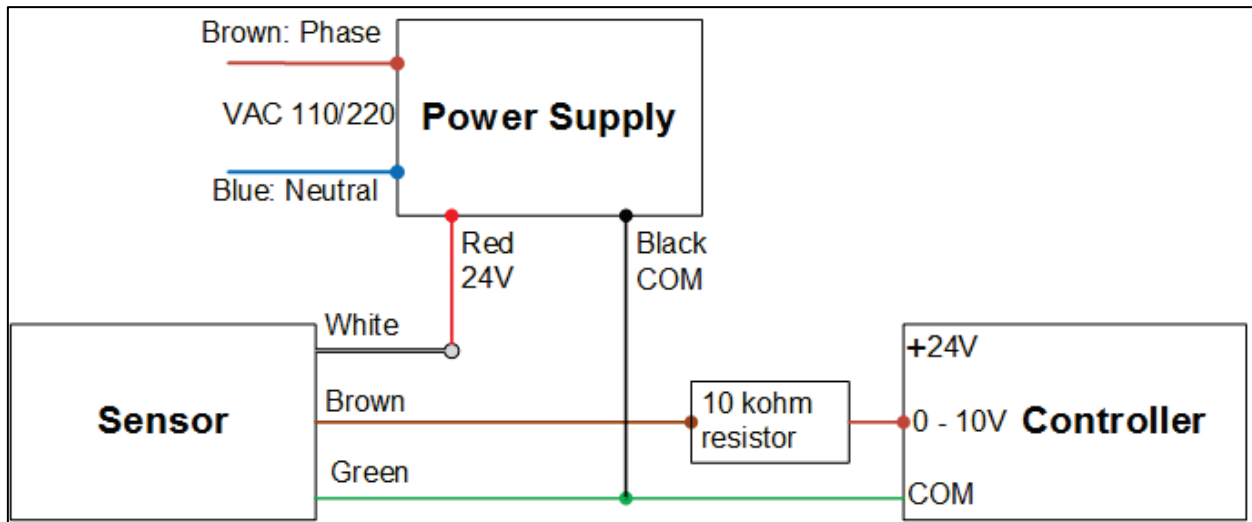

Figure 13: Ammonia Sensor Wiring

#### 12.3.4.2 Jumper Positions

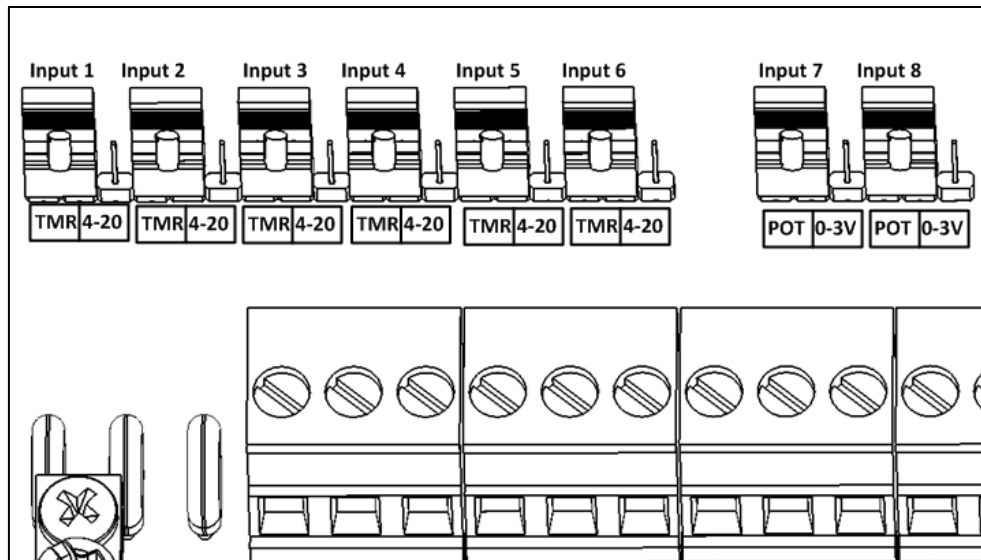

Figure 14: Jumper Positions

- **Inputs 1 – 6:** Temperature sensor or digital device
- **Inputs 7 – 8:** Potentiometers or analog input

### 12.4 Communication Card

AC-2000 3G supports RS-232 and RS-485-Isolated communication wiring. If you need to replace the card, place the new card as shown in Figure 6 (position labeled UART0).

- Wiring
- Communication Card Grounding
- Termination and 5V Setup

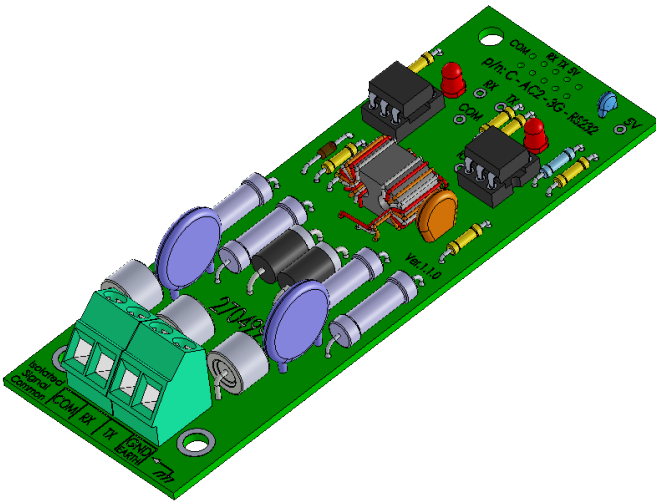

Figure 15: RNET-RS232 Card (P/N 904-99-00041)

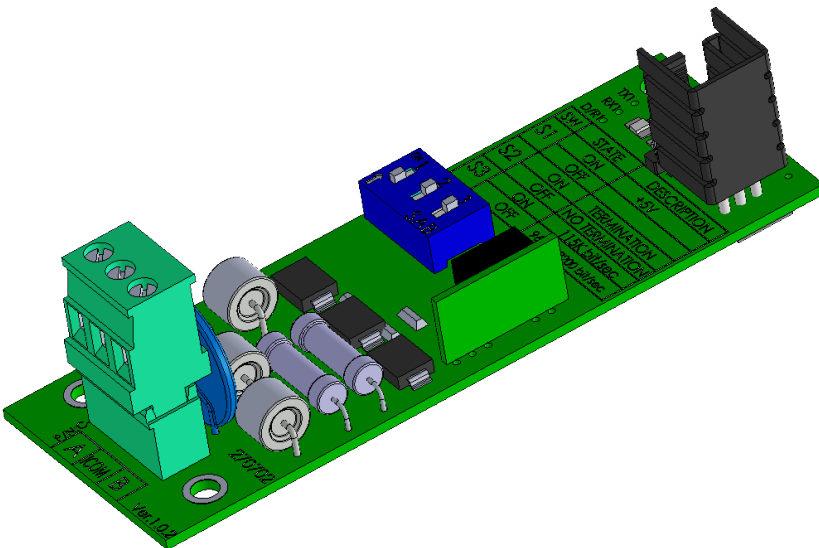

Figure 16: RNET RS-485 Isolated Card (P/N: 905-99-00003)

#### 12.4.1 WIRING

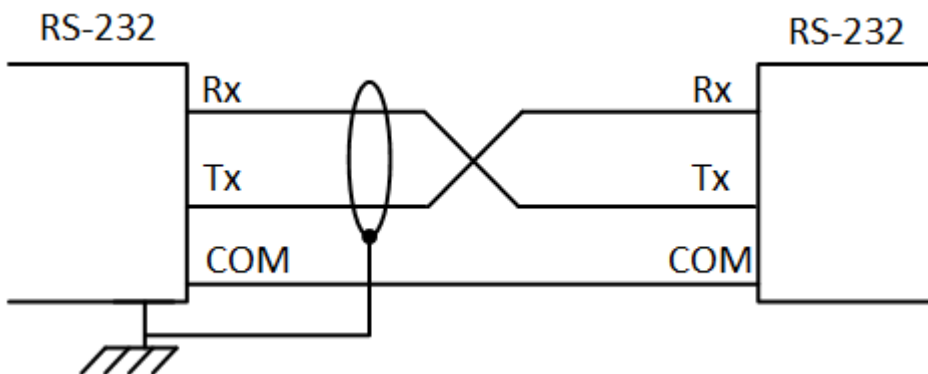

Figure 17: RS-232 Communication Card Wiring



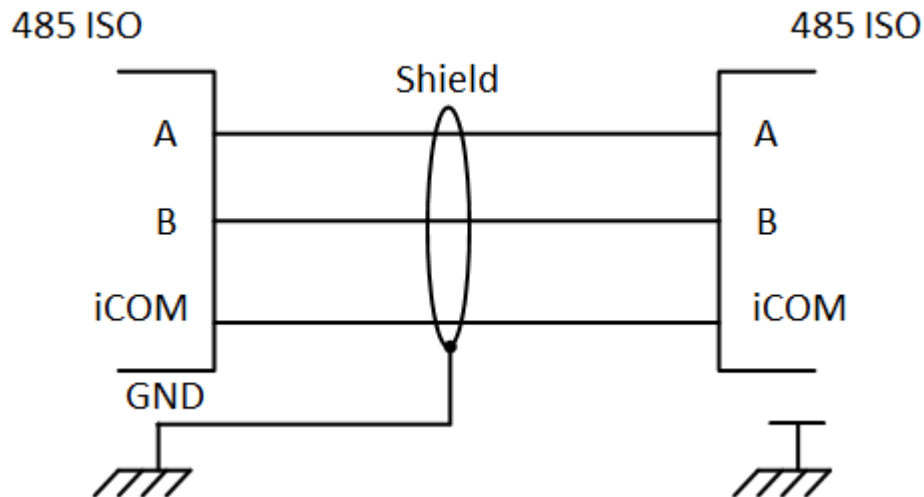

Figure 18: RS-485 (Isolated) Communication Card to MUX/Communicator External Box Wiring

The cable between the external connection box and the controllers should be a two pair twisted shield cable.

- Wiring:
  - 1st pair:
    - Red wire to the controller's terminal A and the external connection box's terminal A.
    - Black wire to the controller's terminal B and the external connection box's terminal B.
  - 2nd pair:
    - Green wire to the controller's COM terminal and the external connection box's COM terminal.
- The final controller in any chain or branch requires a 120 ohm terminator (refer to Termination).

### 12.4.2 COMMUNICATION CARD GROUNDING

- Ensure that a grounding wire runs from the communication card to the ground strip as shown in Figure 19.
- If you need to replace the communication card, connect a grounding wire as shown in Figure 19.

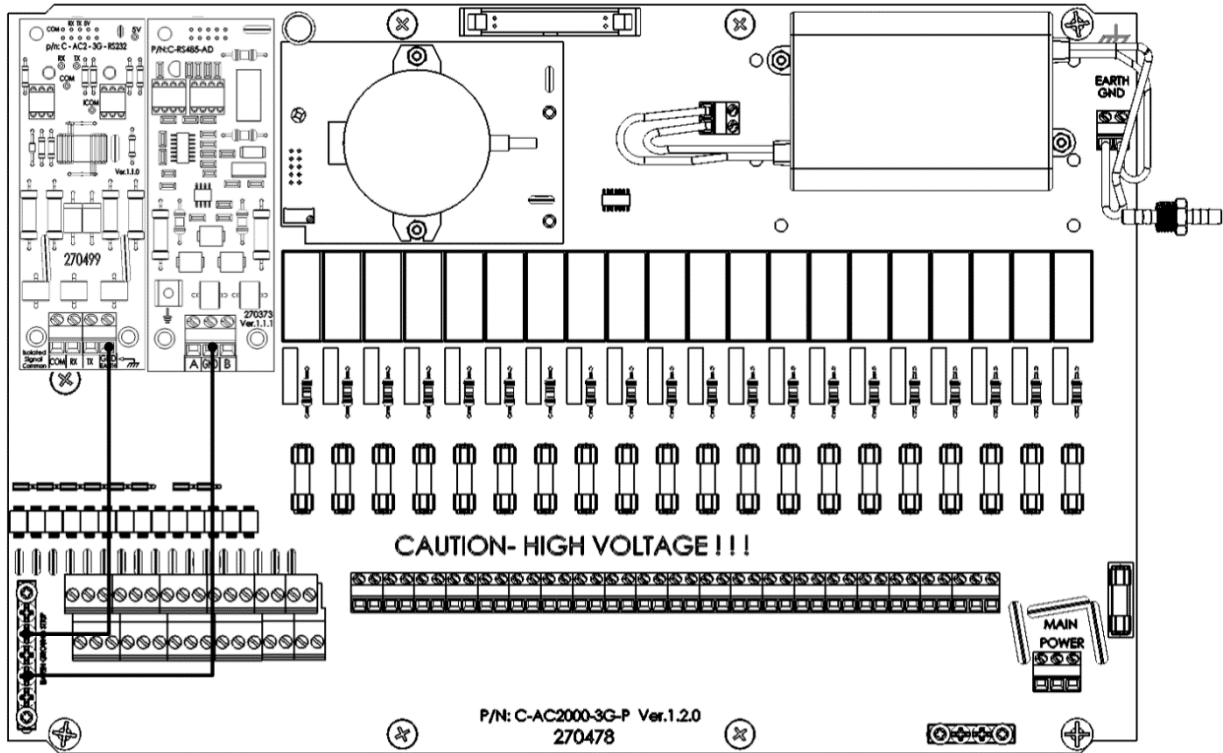

Figure 19: Communication Card Grounding

### 12.4.3 TERMINATION AND 5V SETUP

The AC-2000 3G RS-485 Isolated card has dipswitches used to define termination and 5V.

Below are two common topologies:

- Communicator External Box at one end / AC-2000 3G at one end
- AC-2000 3G controllers on both ends with a Communicator External Box in the middle.

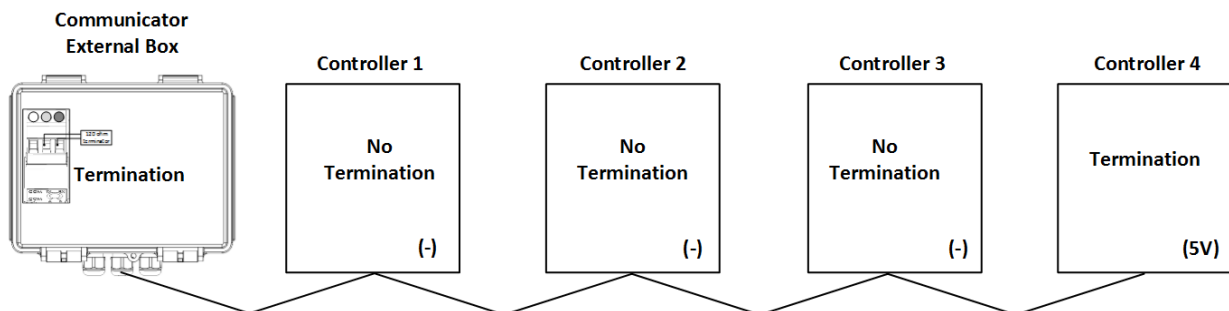

Figure 20: External Box/Controller Termination

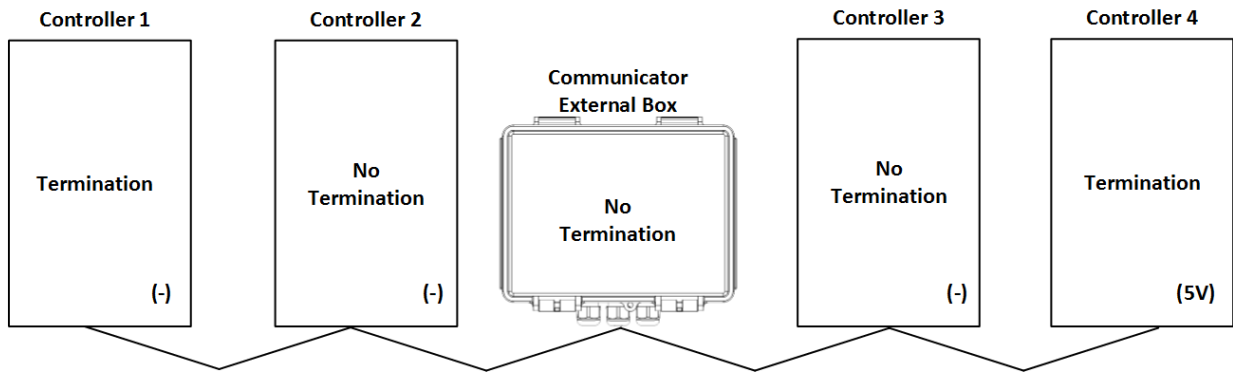

Figure 21: Controller Termination

In any Communicator - AC-2000 3G daisy chain define:

- termination at both end units
- 5V in **ONLY ONE** end unit

The following diagrams illustrate how to set the dipswitches.

- Figure 22 and Figure 23 do not show the 5V dipswitch setting.
- Figure 24 and Figure 25 do not show the termination dipswitch setting.

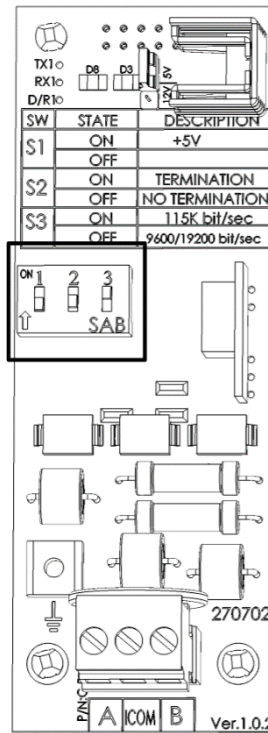
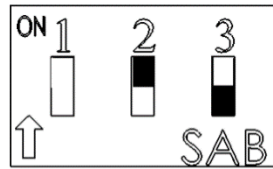
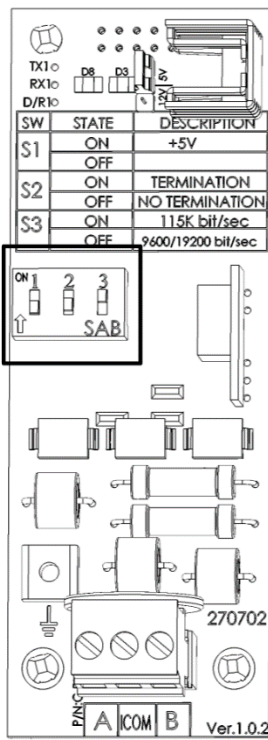

Figure 22: RS-485 Isolated Termination Enabled

Figure 23: RS-485 Isolated Termination Disabled

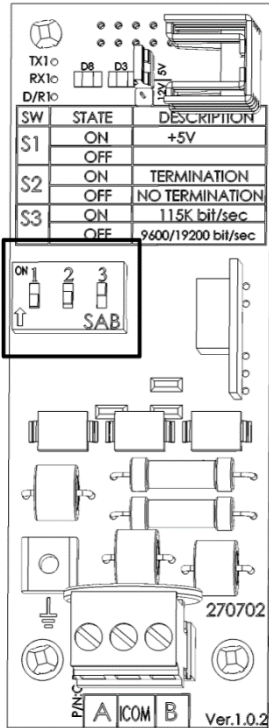

Figure 24: RS-485 5V Enabled

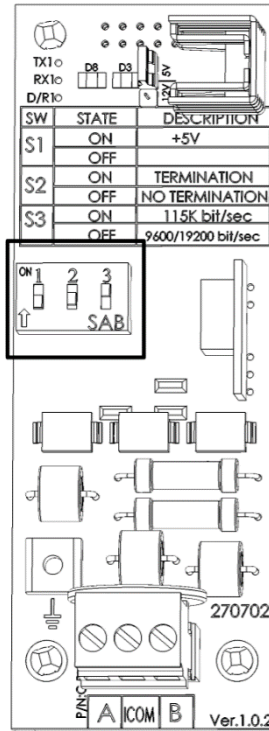

Figure 25: RS-485 5V Disabled

# 13 Appendix A: Data Output

*Table 1: Sensor Readings*

Sensor	Definition
Temp	Displayed with the specific sensor number
Out T.	Outside temperature
Press.	Pressure
Hum. In	Inside humidity
Hum. Out	Outside humidity
Weight	Average weight
Weights	Number of weights
Breaker	Circuit breaker

*Table 2: Output List (Active)*

Output	Definition
Alarm	Can be either active or not. Note that this always appears last.
Heat	Indicates operating heat number
Heat. Hi	Indicates operating heat high number
Tun. Fan	Indicates operating tunnel fan number
Exh. Fan	Indicates operating exhaust fan number
Stir	Indicates operating stir fan number
Cool P.	Indicates operating cool pad number
Fogger	Indicates operating fogger number
Inlet	
Tunnel	
Curt.	Mentions opening percentage
Ext. Sys	Indicates operating external system number
Light	Note that these mention output percentage
Water	Indicates operating water number
Feed	Indicates operating feed number

Output	Definition
Auger	Indicates operating auger number
Rad. Lo	Indicates operating radiant heat low number
Rad. Hi	Indicates operating radiant heat high number

Table 3: Status Readings

Status	Definition
Time	Specific time
Day	Growth day
Set	Target temperature
Offset	Temperature Curve HELP   SET parameter
House mode	Control Mode HELP   SET parameter
Level	Level number
Tunnel, Min. Vent	The controller's state
Fan Off	How long the cycle ends its' operation
Fan On	How long the cycle runs its' operation
Curve off	Occurs when located in low curve temperature or when the Control Mode HELP   SET 'Temperature Curve' parameter is set to OFF.
Hum. Treat	Indicates when treatment occurs
Cool flush	Indicates when flush occurs
Nip. Flush	Indicates when flush occurs

Table 4: Table of Events

Event	Event Explanation
Power Off	Appears when power is off
Power On	Appears when power is on
Cold Start	Appears when cold start is done
Change level to vent	Changes according to a specific stage
Backup set reminder	HELP   SET: 'Set Temp. Change remainder (diff)' parameter
Alarm on	Appears when the alarm is on
Change in setting	
Change in switches	Relay switch setting changed
New flock	Appears when new flock is updated
Reset alarm	Appears when reset alarm is done
System message #	For Munters technicians only

Event	Event Explanation
Alarm card fail	Appears when the alarm card fails
Digital card fail	Appears when the digital card fails
Memory restore	Appears when the system does restore cause by noises
Minimum ventilation	Appears when minimum ventilation occurs
Tunnel ventilation	Appears when entering tunnel ventilation
Alarm test	Appears when alarm test completes
Precision Mode	Switch to Precision Mode
Standard Mode	N/A
Changed growth day	Appears when changing the growth day occurs
MinV L.P Alarm Dis.	Appears when minimum low pressure alarm is disabled
MinV L.P Alarm Ena	Appears when minimum low pressure alarm is enabled
Tun. L.P Alarm Dis.	Appears when tunnel low pressure alarm is disabled
Tun L.P Alarm Ena.	Appears when tunnel low pressure alarm is enabled
Visitor Log in	Appears when the visitor logs in with his password
User #1-5 log in	Appears when the user logs in with his password
Owner log in	Appears when the owner logs in with his password
Change Visitor pass	Appears when the visitor changed his password.
Change User #1-5 pass	Appears when the user changed his password
Change Owner pass	Appears when the owner changed his password
Data read from plug	Appears when data is read from plug
System recover	Appears when the system tries to recover itself, in cases such as noises
System lock	Appears when either using the correct password, or when using hot key '9,' or automatically after 5 minutes
Empty house mode	Appears when setting at a specific time

# 14 Appendix B: Installing a CO2 Sensor and Second Humidity Sensor

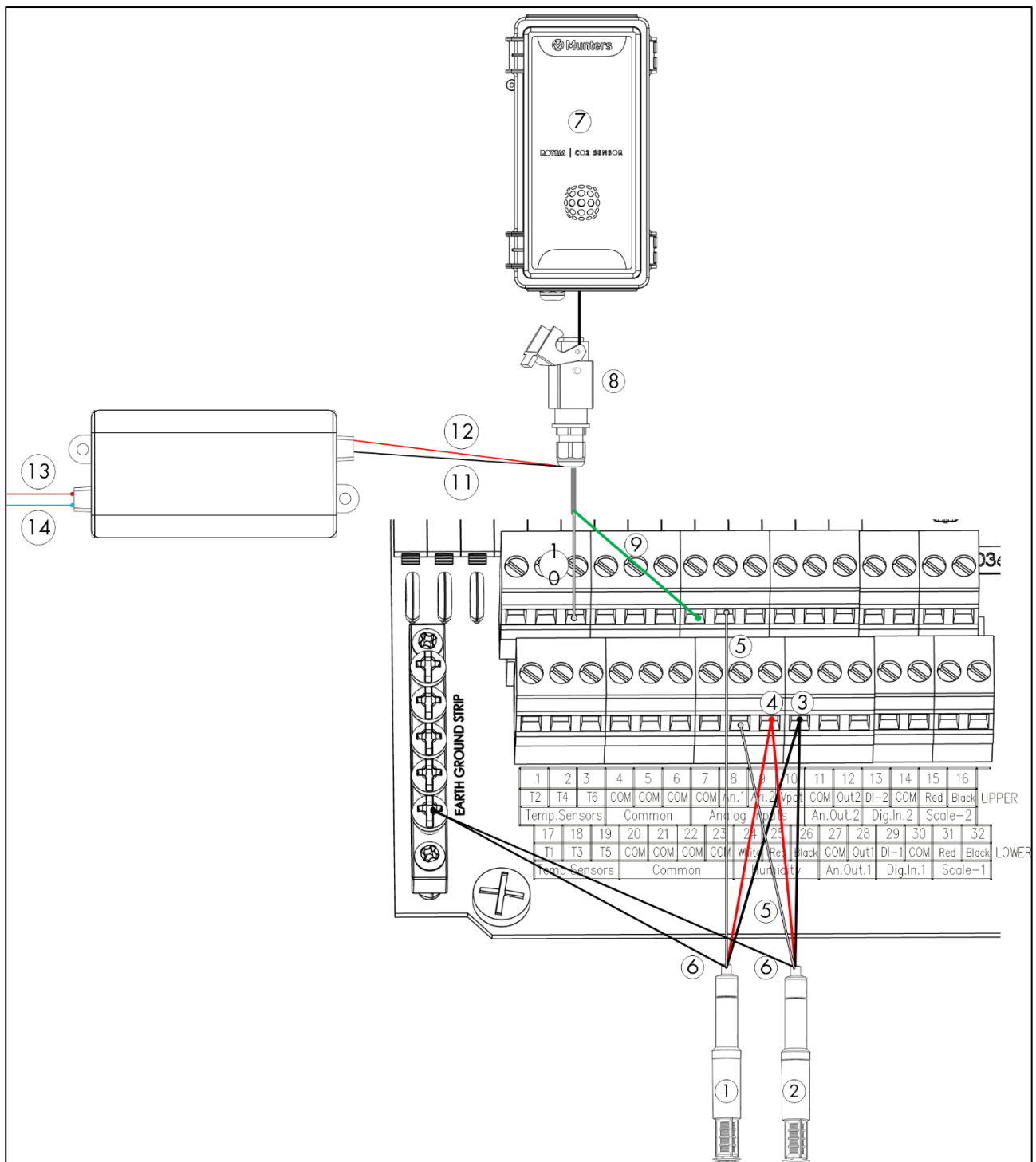

Figure 26: CO2 and Dual Humidity Sensor Wiring



- Key:
  - 1: RHS+
  - 2: Second RHS+
  - 3: RHS+ black wire
  - 4: RHS+ red wire
  - 5: RHS+ white wire
  - 6: Ground wire
  - 7: CO2 Sensor
  - 8: CO2 connector
  - 9: CO2 sensor green wire
  - 10: CO2 sensor white wire
  - 11: CO2 sensor red wire (+)
  - 12: CO2 sensor black wire (COM)
  - 13: CO2 sensor power supply brown wire (phase)
  - 14: CO2 sensor power supply blue wire (neutral)

## 14.1 Humidity Sensor

1. Wire the sensors as shown in Figure 26.
  - Connect the second sensor's white wire to the An.1 or An.2. Port.
2. Place the jumper corresponding to the analog input port on 0 - 3V as shown in Figure 27.

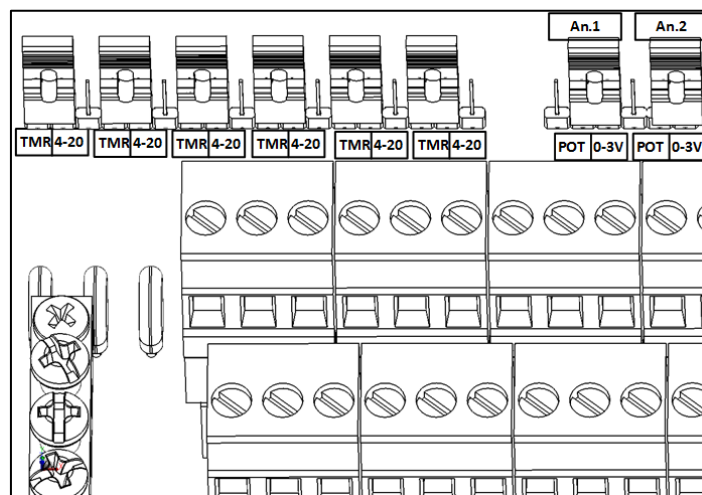

Figure 27: 2nd Humidity Sensor Jumpers

3. In Install > Analog Sensor, define analog input 1 and 2 as humidity sensors.

## 14.2 CO2 Sensor

1. Wire the CO2 sensor as shown in Figure 26.
  - You can connect the sensor's white wire to the T5 or T6 port.
2. Place the jumper corresponding to the analog input port on 4 -20 as shown in Figure 28.

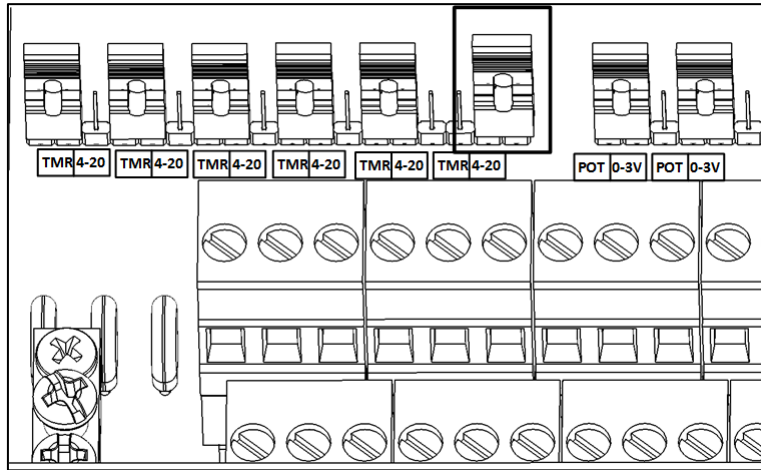

Figure 28: CO2 Sensor Jumpers

3. In Install > Analog Sensor, define an analog input as a CO2 sensor.

# 15 Appendix C: AC-2000 3G Panel Mount

The AC-2000 3G Panel Mount assembly consists of two elements, connected by flat ribbons:

- Base
- Cover
- Metal Assembly Precautions
- Panels
- Panel Dimensions
- Connecting the Metal Panels

## 15.1 Metal Assembly Precautions

Ensure the following:

- The setup meets electrical, mechanical and fire enclosure requirements.
- Clearance and creepage distances are maintained.
- Grounding meets industry standards.
- Ambient temperatures do not go above product requirements (50° C).

## 15.2 Panels

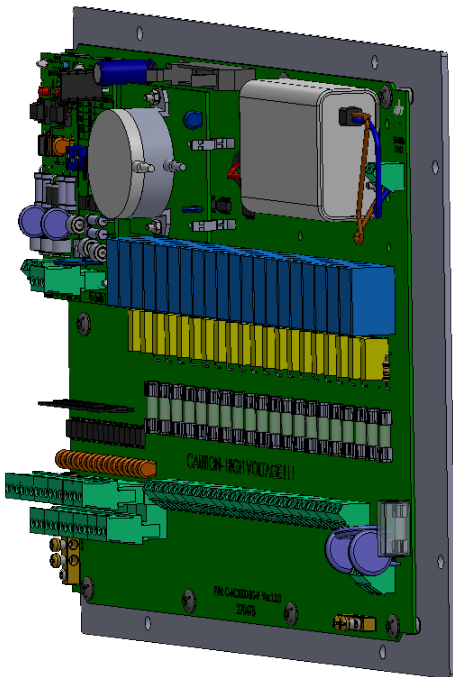

Figure 29: Base

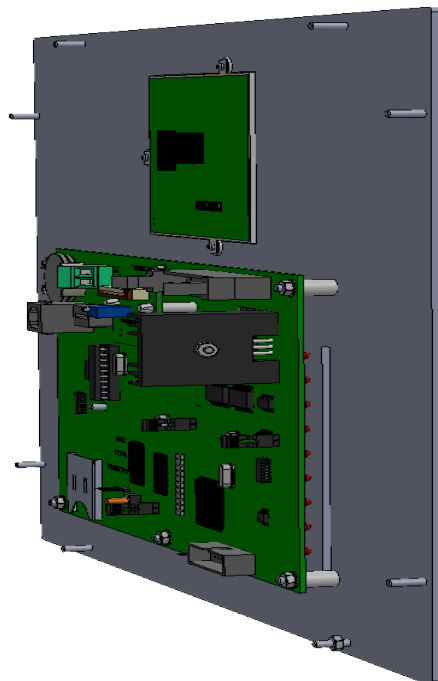

Figure 30: Cover

## 15.3 Panel Dimensions

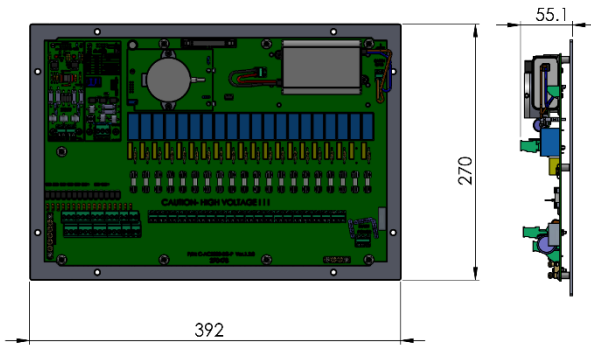

Figure 31: Base Dimensions (mm)

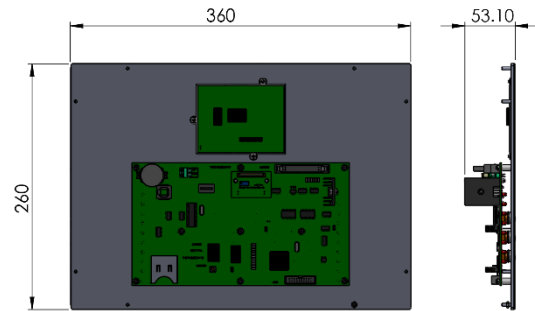

Figure 32: Cover Dimensions (mm)

## 15.4 Connecting the Metal Panels

This section illustrates how to connect the two Metal Panels. The Base and Cover panel come with cables and wiring attached to each panel:

- Base panel: Grounding cable
- Cover panel: Flat cable

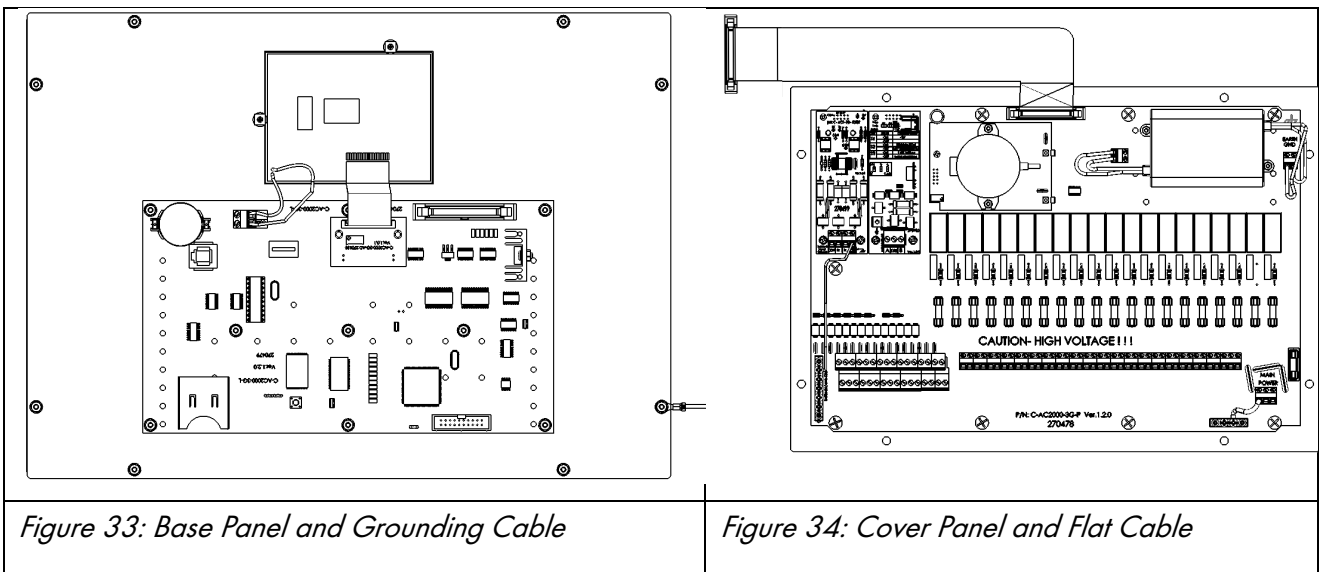

Figure 33: Base Panel and Grounding Cable

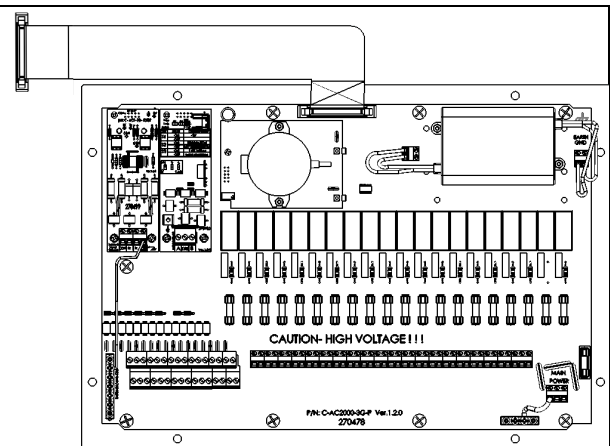

Figure 34: Cover Panel and Flat Cable

### 15.4.1 PRECAUTIONS

- Ensure that the electricity is disconnected before beginning!
- When threading the cables, verify that no high power cables are close to the low power cards (analog input/output and digital input)
- Verify that all connections are properly grounded and shielded as detailed in the manual.

## 15.4.2 PANEL MOUNT CABLE CONNECTIONS

1. Connect the flat cable to the Base Panel.

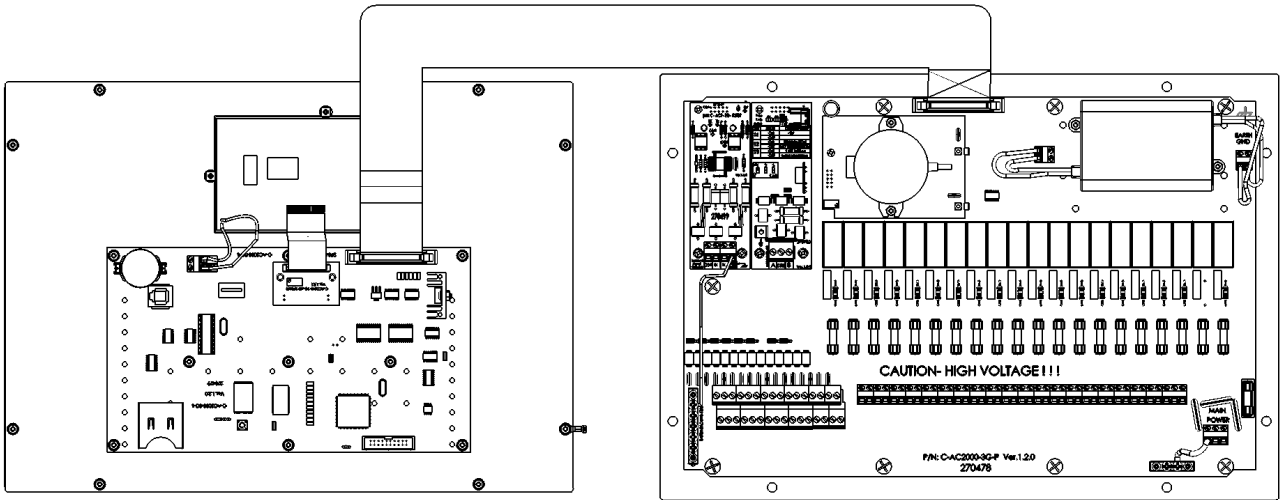

Figure 35: Flat Cable connected

2. Connect the grounding cable to the Cover Panel grounding strip.

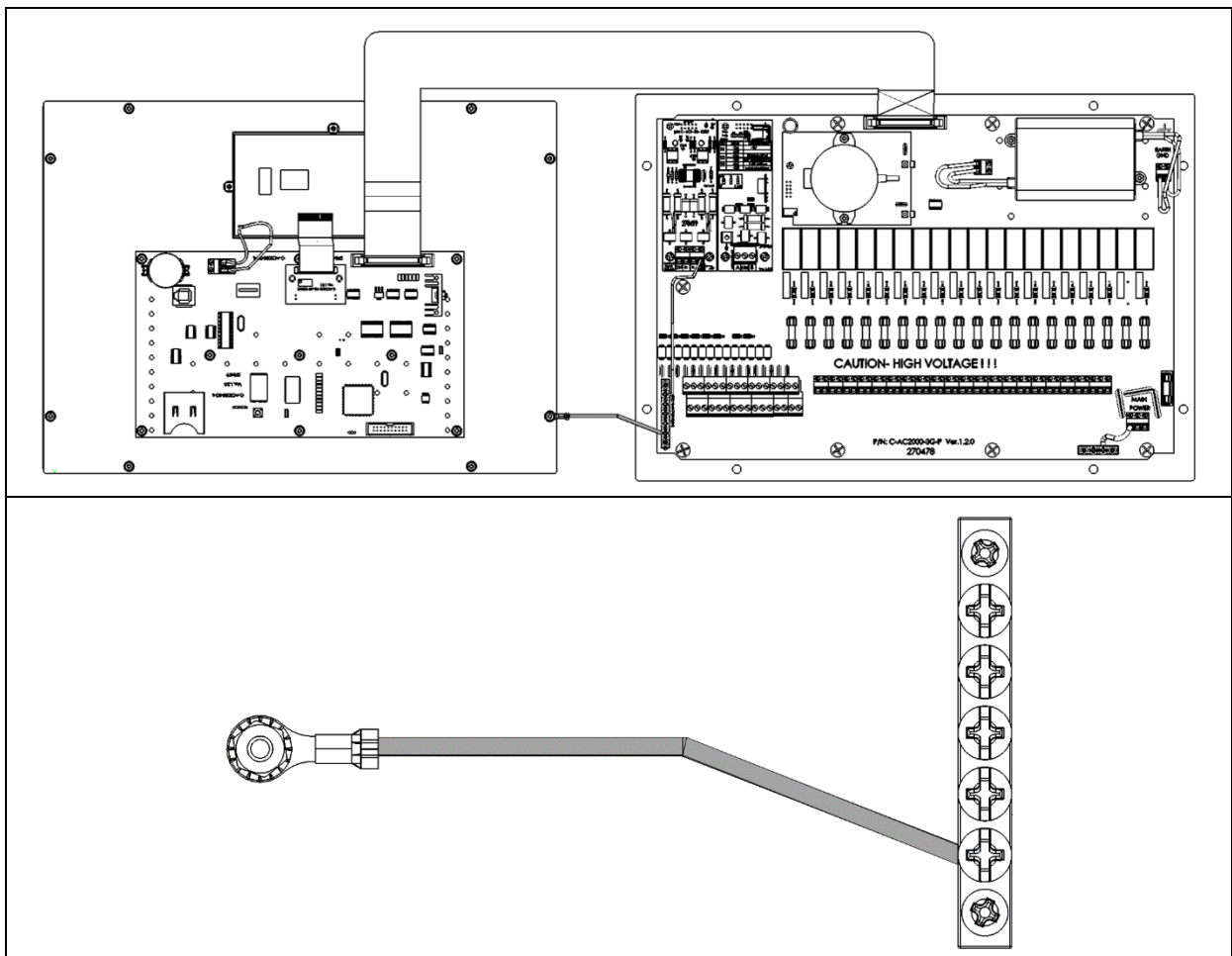

Figure 36: Grounding Cable

# 16 Appendix D: Electrical Grounding for Controllers

Electrical equipment can be destroyed or slowly damaged by voltage spikes, lightning hits, etc. Proper electrical grounding in combination with the controller internal protections is essential to protect the system, reduce the risk of damage and prolong its lifetime. Correct selection and installation of equipment will protect your system and reduce the risk of human injury.

Proper grounding provides an easy path for electrical current to return to its source. A grounding system should tie all non-current carrying conductors to earth ground (0 volts). The grounding system should present a minimum resistance to current flow. Make sure all items used are in proper condition; for example, a corroded wire clamp attaching a ground wire to a ground rod might add 100 ohms or more resistance to a system. Less than 5 ohm will be considered a good ground.

## 16.1 Ground Rods

Ground rods are used to efficiently connect the system to earth where current may be dissipated in the soil.

- Material: Ground rods should be copper clad or galvanized steel.
- Diameter: Minimum 5/8", preferably 3/4". Generally the larger the rod diameter, the lower its resistance to current flow.
- Length: Minimum 2.5 meters (8 feet), preferably 3-meter (10-foot). A longer ground rod will reach a soil with higher moisture content. Moist soil carries current much better than drier soil.
- Single grounding: It is important that there is only one grounding location where a rod or series of rods are connected to each other using a ground wire.
- Independent ground rods will increase the risk of current, from a lightning strike for example, being dissipated through one rod and reentering the system through an adjacent rod.
- Location: Close to the main circuit breaker panel and in moist soil. For example in an area that is usually wet from a drip or a low spot where water drains. Make sure the area is well protected from damage by lawnmowers, tractors, etc.
- Rod installation: Drive the rod into the earth until about 10 cm (4 inches) is left above grade. If it is impossible to drive the rod to the proper depth, it is acceptable to lay the rod horizontally, 80 cm (2.5 feet) below grade.
- In case the rod is exposed to damage, for example by lawnmowers or tractors, it can be installed in a hole, about 20 cm (8 inches) deep so that the rod is about 10 cm under grade and 10 cm above hole level.



The National Electric Code (NEC) mandates two ground rods unless you can show less than 10 ohms resistance with one rod.

## 16.2 Ground Wire

The ground wire is a large copper wire that connects the main circuit breaker panel to the ground rod.

- Material: Ground rods should be copper clad or galvanized steel.
- Diameter: Typically, 16 mm (6-gauge) copper wire is sufficient. If the wire run is greater than 20 feet, 20 mm (4-gauge) wire should be used.
- Length: Minimum 2.5 meters (8 feet), preferably 3-meter (10-foot). A longer ground rod will reach a soil with higher moisture content. Moist soil carries current much better than drier soil.

The ground wire should be protected from damage by lawnmowers, tractors, etc. It should be buried minimum 15 cm (6 inches) underground for protection and enter the house as soon as possible. It is important that the wire not be cut; it should remain continuous.

## 16.3 Ground Clamps

Ground wires should not be merely wrapped around a ground rod. Ground clamps are used to attach a ground wire to a ground rod. The most common clamp is an acorn clamp. Make sure the ground clamps you select are rated for outdoor use. Do not use pipe clamps rated for inside water lines or hose clamps to attach the ground wire.



*Figure 37: Ground Connection*

## 16.4 What Should Be Grounded?

Any equipment that is or could become energized, even accidentally, should be grounded. Current from lightning strikes objects in a random fashion. Accounts of lightning strikes reveal scenarios most of us could not predict.

Electric circuits should be wired with a 3-wire conductor consisting of hot, neutral and grounding wires. The grounding wire should be attached cleanly and securely to devices or systems to be grounded. The other end of the grounding wire should be attached to the ground bus on the main panel.

# 17 Warranty

## Warranty and technical assistance

Munters products are designed and built to provide reliable and satisfactory performance but cannot be guaranteed free of faults; although they are reliable products they can develop unforeseeable defects and the user must take this into account and arrange adequate emergency or alarm systems if failure to operate could cause damage to the articles for which the Munters plant was required: if this is not done, the user is fully responsible for the damage which they could suffer.

Munters extends this limited warranty to the first purchaser and guarantees its products to be free from defects originating in manufacture or materials for one year from the date of delivery, provided that suitable transport, storage, installation and maintenance terms are complied with. The warranty does not apply if the products have been repaired without express authorisation from Munters, or repaired in such a way that, in Munters' judgement, their performance and reliability have been impaired, or incorrectly installed, or subjected to improper use. The user accepts total responsibility for incorrect use of the products.

The warranty on products from outside suppliers fitted to AC-2000 3G, (for example AC-2000 3G's, sensors, cables, thermostats, etc.) is limited to the conditions stated by the supplier: all claims must be made in writing within eight days of the discovery of the defect and within 12 months of the delivery of the defective product. Munters has thirty days from the date of receipt in which to take action, and has the right to examine the product at the customer's premises or at its own plant (carriage cost to be borne by the customer).

Munters at its sole discretion has the option of replacing or repairing, free of charge, products which it considers defective, and will arrange for their despatch back to the customer carriage paid. In the case of faulty parts of small commercial value which are widely available (such as bolts, etc.) for urgent despatch, where the cost of carriage would exceed the value of the parts, Munters may authorise the customer exclusively to purchase the replacement parts locally; Munters will reimburse the value of the product at its cost price.

Munters will not be liable for costs incurred in demounting the defective part, or the time required to travel to site and the associated travel costs. No agent, employee or dealer is authorised to give any further guarantees or to accept any other liability on Munters' behalf in connection with other Munters products, except in writing with the signature of one of the Company's Managers.

***WARNING:*** *In the interests of improving the quality of its products and services, Munters reserves the right at any time and without prior notice to alter the specifications in this manual.*



The liability of the manufacturer Munters ceases in the event of:

- dismantling the safety devices;
- use of unauthorised materials;
- inadequate maintenance;
- use of non-original spare parts and accessories.

Barring specific contractual terms, the following are directly at the user's expense:

- preparing installation sites;
- providing an electricity supply (including the protective equipotential bonding (PE) conductor, in accordance with CEI EN 60204-1, paragraph 8.2), for correctly connecting the equipment to the mains electricity supply;
- providing ancillary services appropriate to the requirements of the plant on the basis of the information supplied with regard to installation;
- tools and consumables required for fitting and installation;
- lubricants necessary for commissioning and maintenance.

It is mandatory to purchase and use only original spare parts or those recommended by the manufacturer.

Dismantling and assembly must be performed by qualified technicians and according to the manufacturer's instructions.

The use of non-original spare parts or incorrect assembly exonerates the manufacturer from all liability.

Requests for technical assistance and spare parts can be made directly to the nearest Munters office. A full list of contact details can be found on the back page of this manual.

### **Munters Israel**

18 HaSivim Street

Petach-Tikva 49517, Israel

Telephone: +972-3-920-6200

Fax: +972-3-924-9834



[www.munters.com](http://www.munters.com)

**Australia** Munters Pty Limited, Phone +61 2 8843 1594, **Brazil** Munters Brasil Industria e Comercio Ltda, Phone +55 41 3317 5050, **Canada** Munters Corporation Lansing, Phone +1 517 676 7070, **China** Munters Air Treatment Equipment (Beijing) Co. Ltd, Phone +86 10 80 481 121, **Denmark** Munters A/S, Phone +45 9862 3311, **India** Munters India, Phone +91 20 3052 2520, **Indonesia** Munters, Phone +62 818 739 235, **Israel** Munters Israel Phone +972-3-920-6200, **Italy** Munters Italy S.p.A., Chiusavecchia, Phone +39 0183 52 11, **Japan** Munters K.K., Phone +81 3 5970 0021, **Korea** Munters Korea Co. Ltd., Phone +82 2 761 8701, **Mexico** Munters Mexico, Phone +52 818 262 54 00, **Singapore** Munters Pte Ltd., Phone +65 744 6828, **South Africa and Sub-Sahara Countries** Munters (Pty) Ltd., Phone +27 11 997 2000, **Spain** Munters Spain S.A., Phone +34 91 640 09 02, **Sweden** Munters AB, Phone +46 8 626 63 00, **Thailand** Munters Co. Ltd., Phone +66 2 642 2670, **Turkey** Munters Form Endüstri Sistemleri A.Ş, Phone +90 322 231 1338, **USA** Munters Corporation Lansing, Phone +1 517 676 7070, **Vietnam** Munters Vietnam, Phone +84 8 3825 6838, **Export & Other countries** Munters Italy S.p.A., Chiusavecchia Phone +39 0183 52 11